

# PROFESSIONAL OUTDOOR GRILLS



INSTALLATION/CARE & USE

# WARNINGS



## WARNING

- Never use dented, rusty or damaged propane cylinders. Never store additional or empty propane cylinders in the grill cabinet or in the vicinity of this or any other appliance. Do not store propane cylinders indoors or on their sides.
- Children should never be left alone or unattended in an area where a grill is located. Place your grill well away from areas where children play. Do not store items that may interest children in or around the grill, in the cart, or in the masonry enclosure.
- Never move the grill when hot. When in use, portions of the grill are hot enough to cause severe burns.
- Always maintain the required clearances from combustibles as detailed. The grill is designed for outdoor use only. Never use in a garage, building, shed, breezeway, or other enclosed area. Do not use this grill under any unprotected overhead combustible construction.
- Gas grills are not designed or certified for and are not to be installed in or on recreational vehicles, portable trailers, boats or any other moving installation.
- Always have an ABC Fire Extinguisher accessible — never attempt to extinguish a grease fire with water or other liquids.
- Storing your grill: Store your grill in a well-ventilated area. If stored indoors, detach and leave L.P. cylinder outdoors in a well-ventilated area away from heat and away from where children may tamper with it.
- Keep any electrical supply cord and the fuel supply hose away from any heated surfaces. Electrical cords should be placed away from walkways to avoid tripping hazard.
- Do not repair or replace any part of the grill unless specifically recommended in this manual. Other service should be performed by a qualified technician.
- If the grill is installed by a professional installer or technician, be sure that he/she shows you where your gas supply shut-off is located. All gas lines must have a shut-off that is readily and easily accessible. If you smell gas, check for gas leaks immediately. Check only with a soap and water solution. (See INDEX: “Leak Testing” for further details.) Never check for gas leaks with an open flame.
- Inspect the L.P. gas supply hose prior to each use of the grill. If there is evidence of excessive abrasion or wear, or the hose is cut, it must be replaced before using the grill.
- Never remove the grounding prong from the plug or use this product with an ungrounded, 2-prong adapter.

**THIS MANUAL MUST REMAIN WITH THE PRODUCT OWNER FOR FUTURE REFERENCE.**

This product complies with ANSI standard Z21.58/CSA 1.6 latest edition and has been tested and approved by Intertek.



To obtain replacement parts or service contact:

**Viking Range, LLC**  
**Preferred Customer Service**  
**111 Front Street**  
**Greenwood, Mississippi 38930**  
**Service: (888) 845-4641**

# WARNINGS



## WARNING

READ THIS MANUAL CAREFULLY and completely before using your grill to reduce the risk of:

1. Fire
2. Burn hazard, personal injury or property damage
3. Ruined steaks or other unpleasant cooking experiences
4. Unapproved installation or servicing.

THIS PRODUCT IS DESIGNED FOR OUTDOOR USE ONLY. Improper installation, adjustment, alteration, service or maintenance can cause property damage, injury or death.

Read this manual thoroughly before installation, use, or servicing of this product.



## DANGER

### IF YOU SMELL GAS:

1. Shut off all gas supply lines to the grill.
2. Extinguish any open flames.
3. Carefully open the lid. Remember, it may be extremely hot!
4. If odor continues, keep everyone away from the grill and immediately call your gas supplier or your fire department.



## DANGER

### S'IL Y A UNE ODEUR DE GAZ:

1. Coupez l'admission de gaz de l'appareil.
2. Éteindre toute flamme nue.
3. Ouvrir le couvercle.
4. Si l'odeur persiste, éloignez-vous de l'appareil et appelez immédiatement le fournisseur de gaz ou le service d'incendie.



## WARNING

1. DO NOT store or use gasoline or other flammable vapors and liquids in the vicinity of this or any other appliance.
2. An LP cylinder not connected for use shall not be stored in the vicinity of this or any other appliance.



## AVERTISSEMENT

1. Ne pas entreposer ni utiliser de l'essence ni d'autres vapeurs ou liquides inflammables dans le voisinage de l'appareil, ni de tout autre appareil.
2. Une bouteille de propane qui n'est pas raccordée en vue de son utilisation, ne doit pas être entreposée dans le voisinage de cet appareil ou de tout autre appareil.



## WARNING! CALIFORNIA PROPOSITION 65

1. The burning of gas cooking fuel generates some by-products which are on the list of substances which are known by the State of California to cause cancer or reproductive harm.
2. California law requires businesses to warn customers of potential exposure to such substances. To minimize exposure to the substances, always operate this unit according to the use and care instructions found in this manual. Be certain to provide adequate ventilation when cooking.

## WARNINGS



### WARNING

1. Always maintain the required clearances from combustible construction as detailed. The grill is designed for outdoor use only. Never use in a garage, building, shed, breezeway or other enclosed area. This grill shall not be used under any unprotected overhead combustible construction.
2. Gas grills are not design certified for and are not to be installed in or on recreational vehicles, portable trailers, boats or any other moving installation.
3. Keep any electrical supply cord and the fuel supply hose away from any heated surfaces. Electrical cords should be placed away from walkways to avoid creating a tripping hazard.
4. Do not repair or replace any part of the grill unless specifically recommended in this manual. Other service should be performed by a qualified technician.
5. All gas lines must have a shut-off that is readily and easily accessible. Be sure the owner knows where the shut-off is located. If you smell gas, check for gas leaks immediately. Check only with a soap and water solution. Never check for gas leaks with an open flame. (See INDEX: "Leak Testing" for further details.)



### WARNING

1. The outdoor cooking gas appliance and its individual shutoff valve must be disconnected from the gas supply piping system during any pressure testing of that system at test pressures in excess of 0.5 psi (3.5 kPa).
2. The outdoor cooking gas appliance must be isolated from the gas supply piping system by closing its individual manual shutoff valve during any pressure testing of the gas supply piping system at test pressures equal to or less than 1/2 psi (3.5 kPa).



### STATE OF MASSACHUSETTS

1. Massachusetts requires all gas be installed using a plumber or gas fitter carrying the appropriate Massachusetts license.
2. All permanently-installed natural gas or propane installations require a "T" handle type manual gas valve be installed in the gas supply line to this appliance.
3. This does not apply to portable propane installations using a 20 pound cylinder.

# TABLE OF CONTENTS

<b>USE &amp; CARE GUIDELINES</b>	<b>6</b>
Grill Models	6
<b>HOW TO LIGHT YOUR GRILL</b>	<b>6</b>
<b>HOW TO LIGHT YOUR ROTISSERIE BURNER</b>	<b>6</b>
<b>BEFORE YOU START</b>	<b>7</b>
If Shipment Arrives Damaged	7
Important Notes	7
<b>SPECIFICATIONS &amp; INSTALLATION</b>	<b>9</b>
<b>UNPACKING &amp; ASSEMBLY</b>	<b>10</b>
<b>GAS CONNECTIONS</b>	<b>12</b>
Natural Gas	12
LP Gas	13
Gas Conversion Kits	14
<b>ELECTRICAL CONNECTIONS</b>	<b>15</b>
<b>FINAL CHECKS</b>	<b>16</b>
Leak Testing	16
<b>CHECKLIST BEFORE EACH USE</b>	<b>18</b>
<b>A MESSAGE TO OUR CUSTOMERS</b>	<b>18</b>
<b>IMPORTANT SAFETY PRECAUTIONS</b>	<b>18</b>
<b>GRILLING IN WINDY CONDITIONS</b>	<b>20</b>
<b>USING YOUR GRILL</b>	<b>21</b>
Pre-Grill Checklist	21
Lighting your Grill	22
Basic Grilling	24
Using the ProSear™ 2 Burner	25
Using the Rotisserie Burner	26
Using the Smoker Box	27
<b>CLEANING YOUR GRILL</b>	<b>28</b>
<b>TROUBLESHOOTING YOUR GRILL</b>	<b>30</b>
Potential Problems	31
Contacting Customer Service	34
<b>VIKING RANGE, LLC LIMITED WARRANTY</b>	<b>35</b>
<b>VIKING RANGE, LLC COMMON AREA LIMITED WARRANTY</b>	<b>36</b>
<b>WIRING SCHEMATICS</b>	<b>37</b>
30 Rotisserie Grill	37
36 & 42 Rotisserie Grill	38
54 Rotisserie Grill	39
<b>PROFESSIONAL GRILLS EXPLODED PARTS VIEW</b>	<b>40</b>
<b>PROFESSIONAL GRILLS PARTS LIST</b>	<b>41</b>
<b>MODEL-SPECIFIC BTU OUTPUTS &amp; MAX. RUNS FOR APPLIANCES</b>	<b>42</b>
<b>INDEX</b>	<b>43</b>

---

## USE & CARE GUIDELINES

---

This use & care manual covers the grill models listed below. Some features and options will vary based upon the model that you purchased.

---

## GRILL MODELS

---

BUILT-IN	FREESTANDING
VQGI5300(N/L)SS	VQGFS5300SS
VQGI5360(N/L)SS	VQGFS5360SS
VQGI5420(N/L)SS	VQGFS5420SS
VQGI5540(N/L)SS	VQGFS5540SS
CVQGI5300(N/L)SS	CVQGFS5300SS
CVQGI5360(N/L)SS	CVQGFS5360SS
CVQGI5420(N/L)SS	CVQGFS5420SS
CVQGI5540(N/L)SS	CVQGFS5540SS

---

## HOW TO LIGHT YOUR GRILL

---

1. Before each use, complete the checklist below.
2. Make sure all burner control knobs are in the "OFF" position.
3. Push and hold the control knob in for 5-7 seconds, allowing the igniter to heat up.
4. Turn the knob to the "LITE" position.
5. After ignition set the knob to the desired setting.

---

## HOW TO LIGHT YOUR ROTISSERIE BURNER

---

**Note:** *The rotisserie burner features a thermocouple sensor with a safety valve that automatically shuts off the flow of gas if the burner goes out for any reason.*

1. Before each use, complete the checklist on page 18.
2. Make sure all burner control knobs are in the "OFF" position.
3. Push and hold the control knob for 5-7seconds.
4. Turn the knob to the "LITE" position and continue to hold the knob in for an additional 30 – 60 seconds to allow the thermocouple to heat up and keep the safety valve open.

## BEFORE YOU START



### WARNING

- Never install this product into a combustible enclosure without an insulated jacket. Doing so could result in fire, property damage and personal injury.
- Never locate the grill under a roof or overhang, in a building, garage, shed or other such enclosed area.
- Never locate the grill under unprotected combustible construction.
- Installation must conform with local codes or, in the absence of local codes, with either the National Fuel Gas Code, ANSI Z223.1/NFPA 54, Natural Gas and propane Installation Code, CSA B149.1, or Propane Storage and Handling Code, B149.2, in Canada.

## IF SHIPMENT ARRIVES DAMAGED

### VISIBLE LOSS OR DAMAGE

Be certain any visible damage to the carton is noted on freight bill or express receipt and signed by the person making delivery.

FILE CLAIM FOR DAMAGES IMMEDIATELY, regardless of extent of damage.

### CONCEALED LOSS OR DAMAGE

If damage is unnoticed until the grill is unpacked, notify the transportation company or carrier immediately and file a “concealed damage” claim with them. This should be done within (15) days of the date delivery is made to you. Be sure to hold on to the container for inspection. We cannot assume responsibility for damage or loss incurred in transit. (See INDEX: “Obtaining Service” for further details.)

## IMPORTANT NOTES

### WHERE’S THE WIND?

When selecting a suitable location, consider important factors such as exposure to the wind and foot-traffic patterns.

If you have a freestanding grill, position it so the prevailing wind blows into the front control panel (at your back when grilling), supporting the proper front-to-rear airflow.

Built-in grills located in areas with prevailing winds should be protected by a wind barrier.

Winds hitting the *back* of the grill directly may cause problems, as well as wind blowing along the *hood gap*.



Be sure wind doesn’t blow into the hood gap.

### HOW LONG IS YOUR RUN?

Keep all gas supply lines as short as possible because gas lines lose pressure over distance and with each elbow and tee that is added. This drop in pressure affects grill performance. (See INDEX: “Gas Supply Line Runs” for further details.)

### ARE YOU “ON-THE-LEVEL”?

Proper leveling during installation is critical. A grill that is out of level will cause erratic burner combustion and inefficient, uneven heating. A carpenter’s spirit level should be used to level the grill both front-to-back and side-to-side.

If the floor is uneven or has a decided slope, re-leveling may be required each time you move a freestanding unit.



## BEFORE YOU START ...*continued*

### BUILT-IN INSTALLATIONS

This built-in grill is designed for easy installation into masonry enclosures.

NOTE: Built-in grills are intended either for installation in a built-in enclosure constructed of non-combustible materials or for an installation in a built in enclosure constructed of combustible material when installed with a insulating jacket (LIJ).

For non-combustible applications, the grill drops into the opening shown in the cutout detail drawing (See INDEX: "Gas Requirements") and hangs from its counter-top trim. A deck is not required to support it from the bottom.

When using the insulated jacket in a combustible enclosure, the jacket must be supported from the bottom by a ledge on each side or a full deck beneath the jacket.

(See INDEX: "Gas Requirements") Pay special attention to the provisions shown for gas line hook-up.

The enclosure should have ventilation holes to prevent gas build-up in the event of a leak. The deck ledges and counter should be flat and level. (refer to ANSI Z21.58 Standard for Outdoor Cooking Gas Appliances, Section 1.7 Enclosures For Self Contained LP-Gas Supply Systems)

This grill requires that a 120 volt, 60 hertz, 15 amp GFI certified outlet be installed by a qualified electrician.

### CLEARANCE TO COMBUSTIBLE MATERIALS

Minimum clearance from the sides and back of the grill to adjacent combustible construction below the counter top surface is 12" from the sides and back.

***Dégagement minimal entre les parois latérales et l'arrière de l'appareil et la construction combustible au-dessous du panneau supérieur de l'appareil (30 cm à partir des parois latérales et 30 cm à partir de l'arrière).***

Minimum clearance from sides and back of grill to adjacent combustible construction extending above the counter top surface is 18" from the sides and back.

***Dégagement horizontal minimal entre les parois latérales et l'arrière de l'appareil et la construction verticale combustible au-dessus de l'appareil (45.7 cm à partir des parois latérales et 45.7 cm à partir de l'arrière).***

Do not use this appliance under unprotected overhead combustible surfaces.

***Ne pas utiliser cet appareil sous une surface combustible.***

A minimum of 6" of clearance is needed on the left side of the grill above the counter top for the motor and skewer.

If the grill is to be placed into a combustible enclosure, an approved insulated jacket is necessary and is available only from your Viking Range, LLC dealer. Insulated jackets have been designed and tested specifically for your grill.

### REAR HOOD CLEARANCE

A 3 inch clearance is required behind the grill to allow the front hood to open.

The grill exhausts combustion products and cooking greases to the back. Never locate the grill where this exhaust will be difficult to clean.

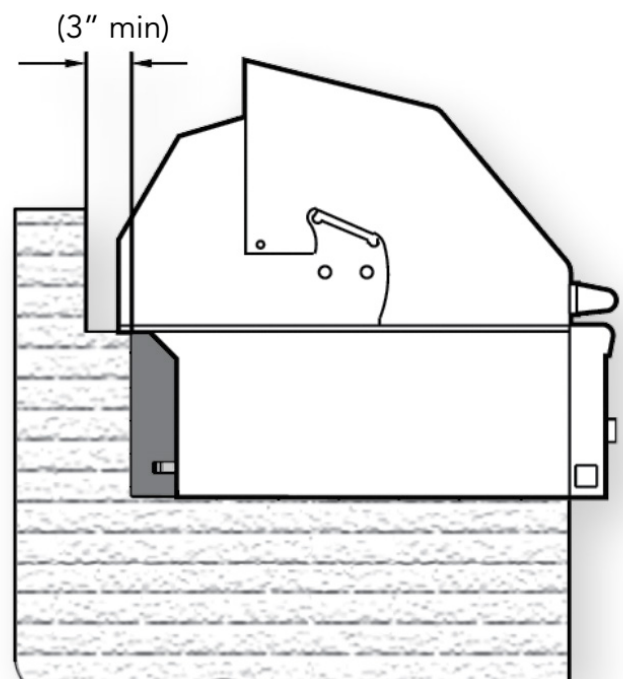



# SPECIFICATIONS & INSTALLATION

The guides, measurements and dimensions detailed below are designated to assist you with planning your outdoor kitchen.

**NOTE:** Due to continuing product innovation, specifications are subject to change without notice.

**IMPORTANT:** Please reference the Care & Use / Installation manual for details on gas plumbing requirements, electrical specifications and the proper installation of your outdoor kitchen equipment. This manual can be downloaded from our website at [www.vikingrange.com](http://www.vikingrange.com) in the US and [www.brigade.ca](http://www.brigade.ca) in Canada.

## GRILLS

MODEL	A	B	C
(C)VQGI5300	29.00	10.88	24.50
(C)VQGI5360	35.00	10.13	22.00
(C)VQGI5420	41.00	10.88	24.50
(C)VQGI5540	53.00	10.88	24.50

## WITH INSULATED JACKET INSTALLED

MODEL	A	B	C
LIJ30	36.00	11.63	26.50
LIJ36	42.00	11.63	24.00
LIJ42	48.00	11.63	26.50
LIJ54	60.00	11.63	26.50

## COMPLEMENTARY PRODUCTS

### SIDE BURNERS

MODEL	A	B	C
(C)VQGSB5130	12.13	10.63	24.50
(C)VQGPB5200	19.00	10.63	22.00

### WARMING DRAWERS

MODEL	A	B	C
(C)VQEWD5300	28.50	10.00	20.50
(C)VQEWD4200	40.25	19.38	24.50

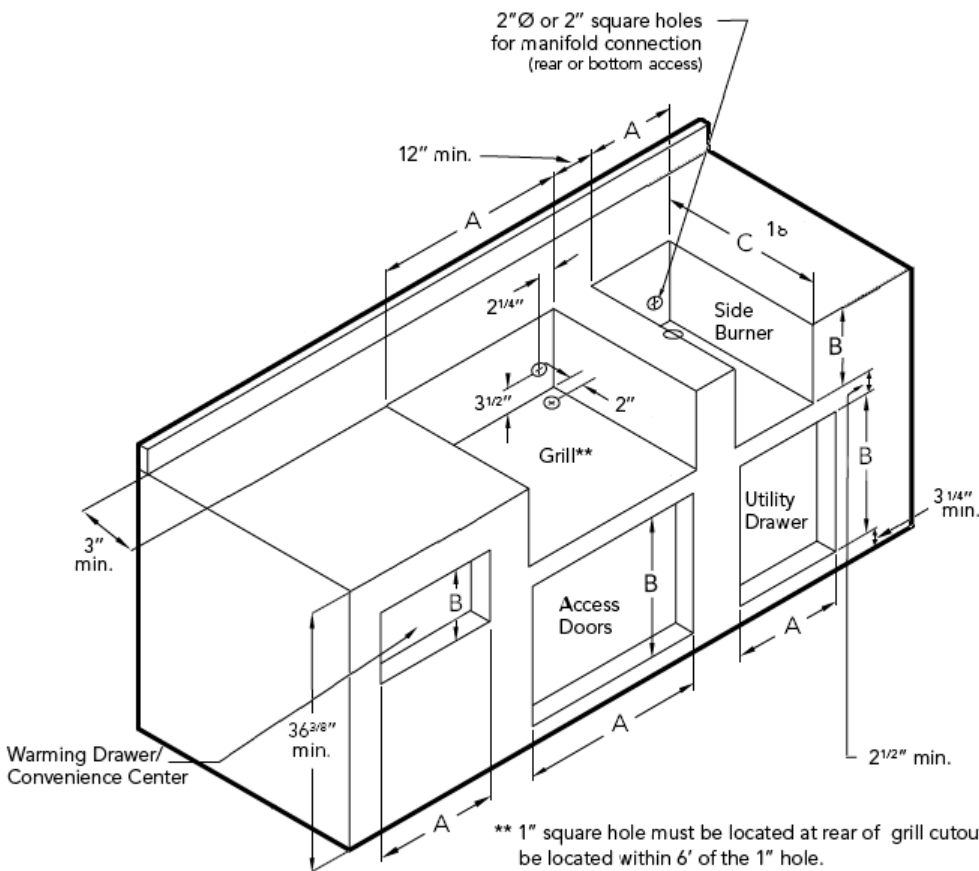
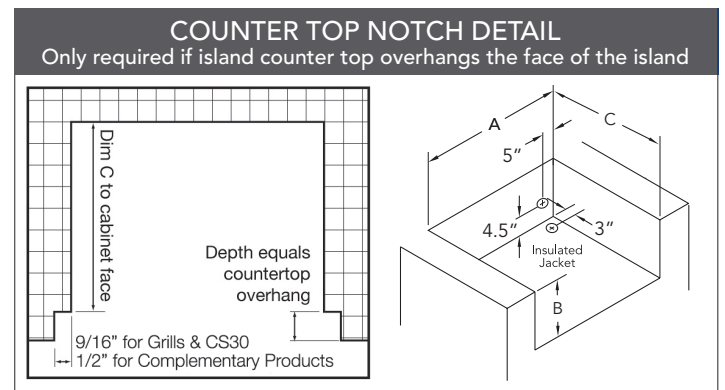

### 3" CLEARANCE

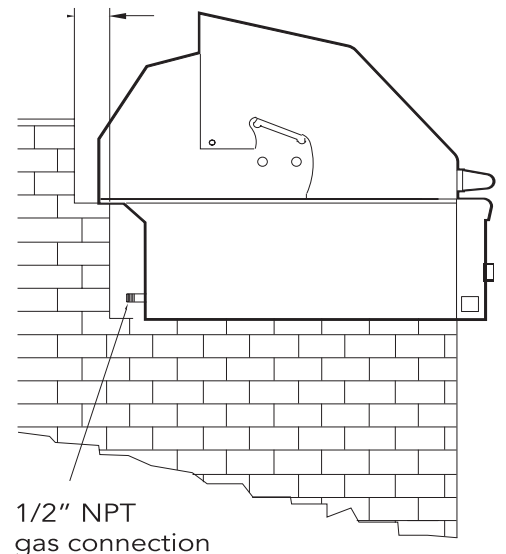

\*\* 1" square hole must be located at rear of grill cutout. 120V GFI outlet must be located within 6' of the 1" hole.

# UNPACKING & ASSEMBLY

The grill arrives nearly ready to use and requires only minor assembly.

By carefully following the uncrating and unpacking steps, you will improve your first experience with the grill.

Shipping weight on smaller units is app. 300 pounds and larger units may weigh over 500 pounds.



## WARNING: EXCESSIVE WEIGHT HAZARD!

Use two or more people to move or install this unit. Failure to follow this instruction can result in back or other personal injuries.

## CRATE & CARTON

- **IMPORTANT!** Do not remove staples around the top of the carton. These staples hold a wooden pallet in place inside the carton that protects the unit from damage. Removing these staples may cause the pallet to fall on the top of grill.

### How to Remove the Carton

- Cut the main strap holding the grill to the pallet.
- Remove the staples at the bottom of the carton.
- Lift off the carton.
- With assistance, remove the grill from the pallet and place into desired location.

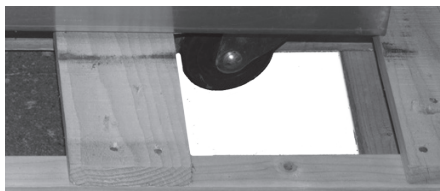

Grill will not slide directly off pallet.

The wheels sit down in the gaps of the shipping crate so that the grill can sit safely and solidly on the crate during shipping. The grill cannot be slid directly off of the pallet.

One way to safely move the grill off of the pallet is by lifting one end of the grill high enough to place a ramp under the wheel and then lift the other end while rolling the grill off of the pallet.



## INTERIOR PACKING

Viking Range, LLC uses sturdy tie-down cables and straps to ensure your grill arrives at your home in the same condition that it left our factory. **BE SURE YOU HAVE REMOVED ALL TIE DOWNS BEFORE USING YOUR GRILL.**

- Remove the white accessory box and wood packing, the grill racks, and remove any loose items from the firebox.
- Carefully cut the cable ties securing the warming rack and rotisserie spit (if equipped).
- Cut the strapping that secures the briquette trays and carefully lift them out, front first.

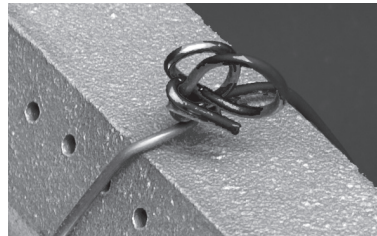

Make sure you remember to remove the tie-downs on the burners.

- On ProSear™ 2 models, cut and remove ties from the burner partition on the left side of the ProSear™ 2 burner.
- Ensure that all burners are properly seated on the burner valve orifice and sitting level with the legs in the frame slots and no side-to-side movement.

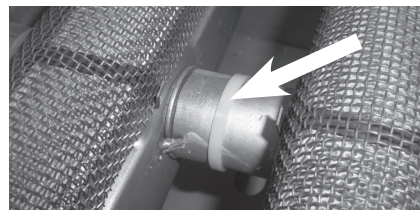

# UNPACKING & ASSEMBLY ...continued

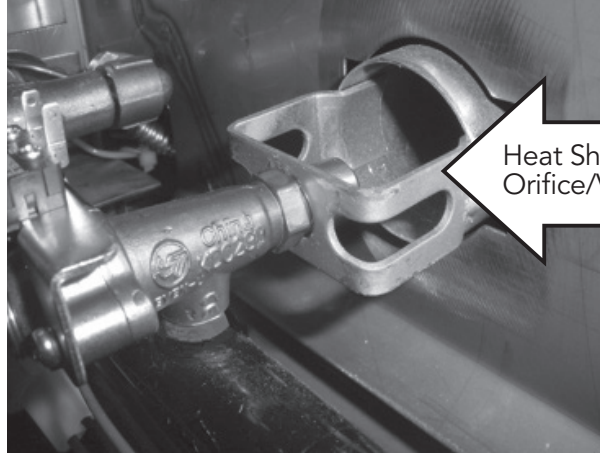

Heat Shield Removed, Orifice/Venturi Position

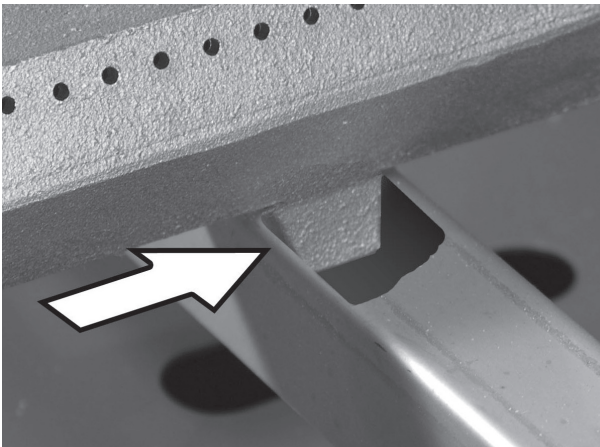
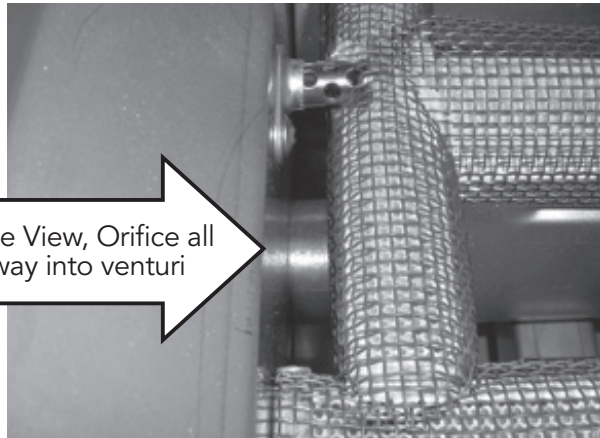
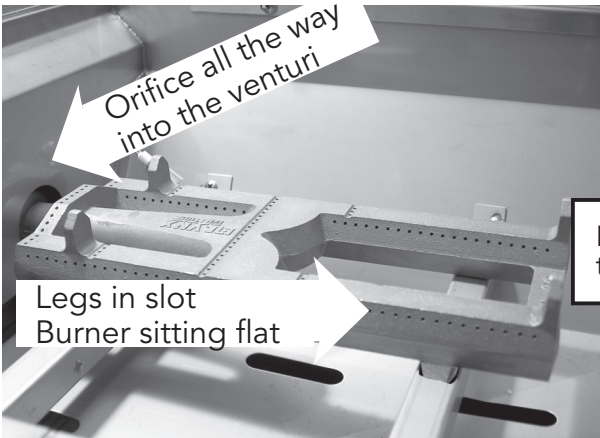

# GAS CONNECTIONS



## WARNING

NEVER CONNECT A GAS LINE DIRECTLY TO THE GRILL. A PRESSURE REGULATOR MUST BE INSTALLED ON ALL GAS EQUIPMENT. ALL LOCAL CODES REQUIRE THAT THE PRESSURE REGULATOR SUPPLIED WITH YOUR GRILL IS USED. REMOVING OR FAILING TO INSTALL THE PRESSURE REGULATOR CAN RESULT IN FIRE AND SERIOUS PERSONAL INJURY AND WILL VOID THE WARRANTY.

The grill is factory set to use either propane (LP) or natural gas (NAT). It is critical that the gas you use matches that which the grill was set up for. You can verify that by checking the **rating plate**.

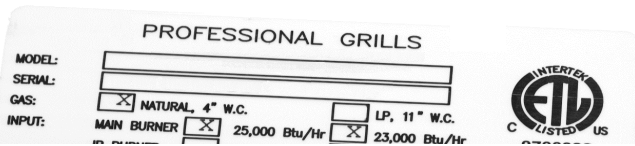

The Rating plate lists serial numbers, model numbers and gas type. This one is underneath the drip tray.

The rating plate is located in one or more of the following places:

- Attached to the underside of the drip tray
- On the heat shield behind the front panel

Ensure that the gas supplied meets with the minimum pressure requirements. Do not operate the grill on any gas other than that for which the grill has been set.

Fuel	WC Max Inlet	WC Min Under Full Load
Nat Gas	7 in	4 in
LP	14 in	11 in

### Water Column Requirements

Both the regulator and the manifold orifices have been tuned for the type of gas specified on the rating plate.

Converting to a different type of gas requires a conversion kit, available from your dealer and must be installed by a qualified technician.

All installation and all installation parts must conform to local codes with the National Electrical Code, ANSI Z223.1/ NFPA 70 latest edition and the National Fuel Gas Code, ANSI Z223.1/NFPA 54 in the U.S. and CGA-B149.1/.2 in Canada.

Canadian installations must conform to CGA-B149.1/.2 natural gas/propane installation code. (Canada)

## NATURAL GAS

Viking Range, LLC recommends that only qualified professionals perform the required plumbing on this product.

To ensure satisfactory performance, the gas supply line must be sized to accommodate the total BTU requirements of all the gas-fired equipment that will be connected to that line.

In no case should pipe less than 3/4" inside diameter or 1" outside diameter ever be used to connect this product.

- Calculate the total BTU output of all equipment and refer to "INDEX: Gas Supply Line Runs" for allowable run distances for 3/4 inch pipe. Failure to meet these minimum requirements may reduce performance of the grill and any other appliances running on that supply line.
- Always keep supply line runs as short as possible. (See INDEX: "BTU Output" for specific model outputs)
- A gas shut-off valve must be installed in an easily accessible location by a qualified plumber.
- Keep threading compound off of the first two pipe threads to avoid having any small pieces of compound break loose and clog a burner valve or orifice. Do not use threading compound on any flare fittings.

For built-in installations, it is recommended that any flexible pipe used be kept as short as possible. (See INDEX: "Gas Connections" for typical permanent hook up.)

Keep last two threads clean

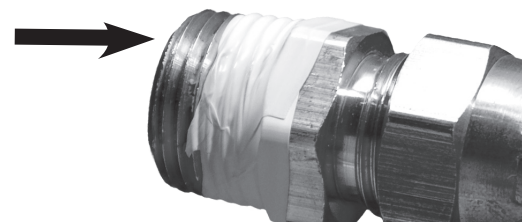



## GAS CONNECTIONS ...continued

For freestanding units using natural gas, using a metal flex hose is recommended.

This is available at your local hardware store or from your dealer.

### LP GAS

Grills set up for LP gas come equipped with an LP hose/regulator assembly for connection to a standard 20 lb. LP cylinder. (Type 1). All fittings necessary to attach the assembly to the grill are included.

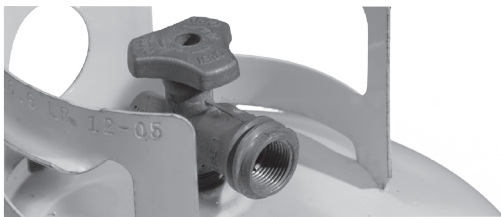

LP cylinder with type 1 valve connection

Permanently plumbed LP connections, such as those in line with a bulk cylinder, require a 4/11 regulator.

When using the 4/11 regulator you must ensure that it is set for the proper fuel type. This is done by removing the regulator cap and gasket and looking at the bottom of the plunger to see what fuel type is visible. This is the regulator fuel setting. NAT is for natural gas and LP is for propane gas. The LP setting can be further identified by the large diameter disk on the bottom of the plunger. To change from one gas to the other simply push the plunger to the side to snap it out of the cap, turn the plunger so it reads the desired gas type on the bottom, and push the plunger until it snaps back into place in the cap then replace the cap into the regulator.

Never connect an unregulated gas line to the grill.

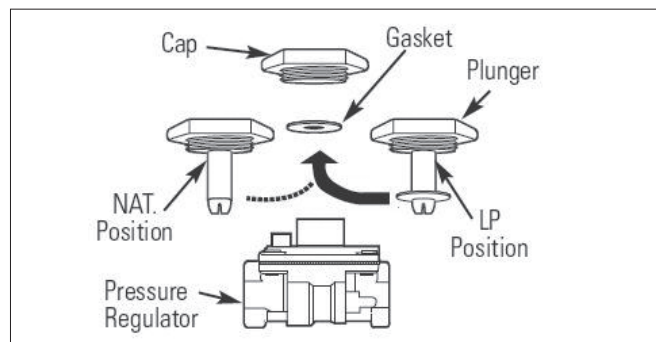

### WARNING

Do not change the regulator/hose assembly or use any other assembly than the one supplied with your grill.

Do not attempt to use a 5LP-A equipped regulator/hose assembly with a standard 510 POL cylinder/valve assembly.

Do not store a spare LP-gas cylinder under or near this appliance.

Never fill the cylinder beyond 80 percent full.

If the information above is not followed exactly, a fire causing death or serious injury may occur.

### LP Cylinder Requirements

The LP cylinder must be constructed and marked in accordance with the specifications for LP gas cylinders of the U.S. Department of Transportation (DOT) and designed for use with a Type 1 system only.

Cylinders of free standing grills must be secured using the provided cylinder retention system to avoid accidental movement.

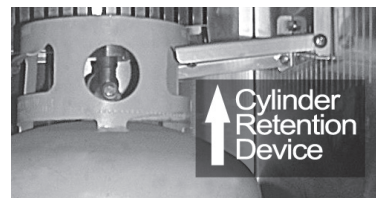

When exchanging your cylinder for a refill, exchange only for a Type 1 20lb cylinder with an over-fill protection device.

Never use a cylinder with a damaged valve.

A dented or rusty LP cylinder may be hazardous and should be avoided. If in doubt, have it checked by your LP supplier.

Always check for leaks after every LP cylinder change. (See INDEX: "Leak Test" for further details.)

Always shut off the LP-gas supply at the cylinder when the grill is not in use.

Cylinders must be stored outdoors in a well-ventilated area out of the reach of children. If your grill is stored indoors, the LP cylinder must be stored outside.

### LP Connections

Make sure the LP cylinder valve is fully closed. It is possible for the valve to be open without releasing gas but, as soon as you start connecting the regulator, gas will leak from the connection.

## GAS CONNECTIONS ...continued

Insert the regulator inlet into the cylinder valve and turn the black coupler clockwise until the coupler is hand tight. Do not over-tighten this connection.

To disconnect the coupler, first make sure the main cylinder valve is turned off. Grasp the coupler and turn counter clockwise. The inlet will then disengage.

Always leak-test the connection after refilling or exchanging LP cylinders. (See INDEX: "Leak Test" for further details.)

### GAS LINE PURGING

You should purge the gas line of air before attempting to light the grill.

- Make sure all grill controls are in the "OFF" position.
- Slowly turn on the main gas supply.
- Push in the rotisserie knob and confirm that the igniter is glowing. It is furthest from the fuel source and will completely purge the lines. It will take several seconds for the burner to light.
- Hold the knob ON for about 20 seconds to allow the air in the system to purge and the burner to light
- Wait at least 5 minutes after shutting off the control before attempting to light the burners.

### GAS CONVERSION KITS

Gas conversion kits are available from Viking Range, LLC to allow the grill to operate on either Natural gas or LPG. These kits should be installed by a qualified technician.

The kits come with complete installation instructions. These instructions should be read completely and fully understood before installing the conversion kit.

### BUILT-IN SIDE BURNER INSTALLATION

- Shut off the gas supply at the main valve.
- Disconnect all plumbing (if already attached) from the grill and the gas supply valve.
- Remove all the fittings from the grill manifold.
- Install the side burner into the counter top cutout.
- Connect the gas supply to the grill and side burner as shown in the two diagrams on this page.
- Turn the gas supply on and leak test all connections. (See INDEX: "Leak Test" for further details.)

### CART INSTALLATION

- Shut off the gas supply at the main valve.
- Disconnect all plumbing (if already attached) from the grill and the gas supply valve.
- Remove all the fittings from the grill manifold.
- Install the side burner onto the cart according to the directions supplied with the cart mounting kit.
- Connect the gas supply to the grill and the side burner as shown in the diagrams on this page for your gas type.
- Turn the gas supply on and leak test all connections. (See INDEX: "Leak Test" for further details.)

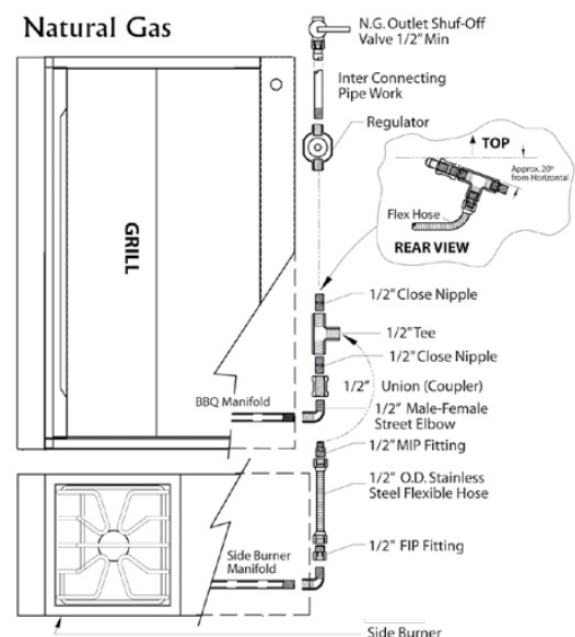
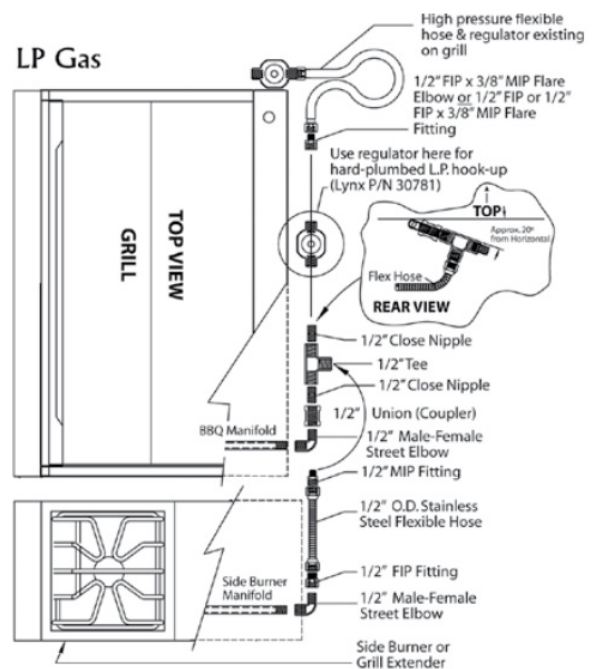

# ELECTRICAL CONNECTIONS



## WARNING: ELECTRICAL GROUNDING

- Product installation must meet local electric codes or, in the absence of local codes, the latest edition of the National Electrical Code ANSI/NFPA No. 70 or the Canadian Electrical Code CGA 1.6b2005.
- Use only a Ground Fault Interrupter (GFI) protected circuit with this outdoor cooking gas appliance.
- **IMPORTANT:** When connecting your rotisserie motor, first connect the motor to the grill and then plug the grill into the outlet.
- This grill is equipped with a three prong (grounding) electric plug for your protection against shock hazard and must be plugged directly into a properly grounded three prong outlet. Never cut or remove the grounding prong from this plug.
- Use only extension cords with a 3 prong grounding plug, rated for the power of the equipment, and approved for outdoor use with a "W-A" marking.
- To protect against electric shock, do not immerse any part of the power cord, an extension cord or any plugs in water or other liquid.
- Unplug the product from the outlet when not in use and before cleaning. Allow it to cool before putting on or taking off parts.
- Do not let the cord hang over the edge of a table or touch hot surfaces.
- Do not use an outdoor cooking gas appliance for purposes other than intended.
- Do not operate any outdoor cooking gas appliance with a damaged cord, plug, or after the appliance malfunctions or has been damaged in any manner. Contact the manufacturer for repair.

## CONNECTION TO AC

Installation requires an outdoor 120VAC 15A GFI (Ground Fault Interrupter) electrical outlet adjacent to the grill.

The GFI outlet features an internal breaker that reduces shock hazard. This type of outlet should be installed by a qualified electrician either inside the island enclosure for built-in units, or near the location where a free-standing unit will be used.

For built-in grills, the supplied 12VDC should be installed below the grill within the cabinet enclosure. Select a location where the transformer is protected against water, heat and physical damage.

When installing the transformer to the grill be careful to prevent the wiring and transformer from contacting any hot surfaces behind or below the grill. It is recommended that the transformer be located below the grill in a readily accessible location. Be sure to provide adequate access to facilitate service if the transformer or connections should need future maintenance.

If the electrical system fails to operate, a connection may have come loose in shipping or the GFI may have tripped, requiring a reset. See the Troubleshooting section for more details.



# FINAL CHECKS

## LEAK TESTING



### DANGER!

To prevent fire or explosion hazard, DO NOT smoke or allow any potential source of ignition (sparks, electrical arcing, etc) in the area while performing a leak test. Leak tests should be conducted outdoors only. Never conduct a leak test using fire or flame.

### Leak Test Procedure:

- Create a soapy solution of 1 part soap and 3 parts water.
- Confirm that all control knobs are in the off position.
- Turn on the fuel supply. For natural gas, turn the valve handle 1/4 turn to align with the gas flow.
- For L.P., turn the cylinder valve knob counter clockwise one full rotation.
- Apply the soap solution generously by paint brush or squirt bottle on all connections and fittings.
- If bubbles appear to “grow” on any of the connections, you have a gas leak. IMMEDIATELY turn off the gas supply.

### Fixing a Gas Leak:

- Shut off the gas supply
- Turn all grill controls to the “ON” position to purge the grill of any gas build-up, then turn the controls back “OFF”.
- Wash off the soapy solution with cold water and dry.
- Tighten the loose joint, or replace the faulty part with manufacturer-recommended replacement parts.
- DO NOT attempt to repair the L.P. cylinder valve if it is damaged. The only way to safely resolve a damaged cylinder is to REPLACE IT.
- Repeat the leak test to ensure that no leaks are present.

## LOW HEAT BURNER ADJUSTMENT

### FOR MAIN BRASS BURNERS AND SIDE BURNERS ONLY!

### DO NOT ADJUST THE ROTISSERIE BURNER.

The main brass burners and side burners on your grill feature an adjustable low setting.

Fluctuations in gas pressure, gas conversion and even in the quality of the gas itself may affect burner performance at the “LOW” setting. It could be either too high or too low.

### To Adjust the Burner to a Low Setting:

- Make sure the grill is cool.
- Remove the racks so you can see the flames while adjusting the burners.
- Light the burner and allow it to preheat on high for 3 minutes.
- Turn the burner to “LOW”.
- Pull off the control knob.
- While holding the valve shaft with pliers as shown insert a small flat screwdriver into the center shaft and adjust the flame’s low setting.

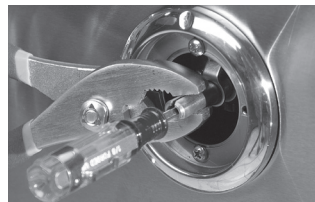

Clockwise will lower the flame setting, counterclockwise will raise it.

The proper setting is where the flame is stable at its lowest setting. A slight flutter will be present in the crossover portion of the front of the burner before the burner itself becomes weak.

The factory setting for propane gas is 1/2 to 3/4 turn from the very bottom of the adjustment. The setting for natural gas is 1-1/2 to 1-3/4 from the bottom. After the low settings are proper, turn all burners to high for visual inspection.

**Please note the low flame adjustment is not available for the rotisserie valve.**

## FINAL CHECKS ...continued

### BRASS BURNER FLAME/AIR SHUTTER ADJUSTMENT

The amount of air that enters a burner is controlled by the *air shutter*.

Each grill burner is tested and adjusted at the factory prior to shipment. However, fluctuations in gas pressure, gas conversion and even in the quality of the gas itself may make it necessary to adjust the burner.

The flames of the main brass burners should be visually checked.

Flames should be blue and stable with slight yellow tips. The bright-blue core should be about 3/8 inch high with a total flame height of about 1 1/2 inches.

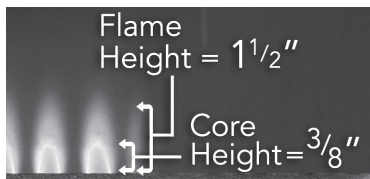

The flames should burn quietly (no "torch" sounds) and they should not "lift" up from the burner.

If your flames do not match those indicated in the photo, ensure that the air shutter and burner ports are free and clear of dirt, debris, or spider webs. If clear, then adjust the air shutter.

It is locked in place by a screw which must be loosened before adjusting. Once adjusted retighten the screw.

#### To Adjust:



**DANGER!**

BE EXTREMELY CAREFUL AROUND HOT BURNERS AND OTHER GRILL PARTS.

- Remove the racks and briquette trays.
- Lift out the burner, loosen the set screw and then put the burner back in place and light it.
- If the flame is excessively yellow, indicating insufficient air, CAREFULLY turn the air shutter counter-clockwise to allow more air to the burner.

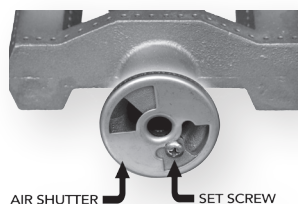

- If the flame is noisy (sounds like a torch) and tends to lift away from the burner, indicating too much air, turn the air shutter clockwise.
- After the burner cools down, remove it, tighten the air shutter set screw and reinstall the burner, briquette trays and grill racks.

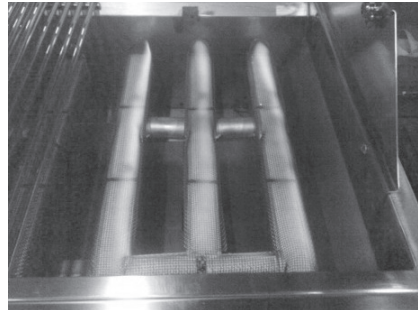

NOTE: The ProSear™ 2 does not have an air shutter.

- The appearance of the ProSear™ 2 burner should be visually checked. The ceramic tiles should be uniformly red to orange in appearance. There should be no lifting, fluttering or lazy blue flames. Some food particles will show as yellow flames but should burn off.

### ONE LAST THING

Finally, before leaving, check all the burners for proper operation. Make sure the control knobs turn freely and completely through their full range.

#### IMPORTANT:

**Make sure the owner knows where the main gas supply shut off valve is located.**

**Finally, for safety and for proper use & care, you must leave this manual with the owner. Make sure you advise them to keep it for future reference.**

For technical assistance call:

**Preferred Customer Service  
888-845-4641**

## CHECKLIST BEFORE EACH USE (FOR YOUR SAFETY)

- Do you smell gas? If yes, shut off everything and call the gas company or a qualified plumber to check for leaks, if not please continue.
- Are you prepared to stay with the grill during the entire cooking process? If not, gather what you need before starting the lighting process. If yes, please continue.
- Is your cooking area free and clear of any combustibles, besides your food, that might ignite? If not, clear the area before starting the lighting process, If yes, please continue.
- Do all control knobs turn freely? If not, call for service, if yes, please continue.
- If you are using a portable propane cylinder, is it connected and leak tested? If not, check the connection before continuing. If yes, please continue.
- Do you know where your grill's main gas supply shut off valve is located? If not, locate it before continuing. If yes, please continue.
- Are all burners properly seated in the grill with mounting legs in slots? If not, seat the burners properly before continuing. If yes, please continue.
- Is the wind blowing just lightly and not blowing on the back of the grill? If not, wait until the wind subsides or turn your free standing grill so the wind goes into the front of the grill. If yes, please continue with the lighting process.

## A MESSAGE TO OUR CUSTOMERS

You've just joined a discriminating collection of amateur and professional chefs that take outdoor cooking to a new level.

Your grill has been designed and built with meticulous attention to detail and it offers some unique and powerful features. You can achieve maximum performance and enjoyment of these features only by carefully reading this manual ... before your first cook-out.

This manual includes important safety tips and great hints for better grilling. You'll want to keep it handy for easy reference.

Also, we enjoy hearing from our customers. We like to hear about your successes but also about any difficulties you are having. Please feel free to contact us with any questions or problems, or just to share a new recipe. Please include the model number of your grill in your correspondence.

With the proper use and care this product will provide years of trouble-free service.

Should your grill change ownership, please make sure that the new owner receives this manual.

Thanks again for your purchase. Enjoy!



---

## IMPORTANT SAFETY PRECAUTIONS

---

### PLEASE REVIEW THESE IMPORTANT SAFETY PRECAUTIONS BEFORE YOU USE YOUR GRILL.

1. NEVER LEAVE THE GRILL UNATTENDED WHILE COOKING.
2. Ensure all tie-down wires have been removed from the burners.
3. Always use caution when operating the grill in a windy area. (See INDEX: "Grilling in Windy Conditions" for further details.)
4. Avoid wearing loose-fitting garments or long sleeves while grilling. They could ignite.
5. Never touch the grill racks, hood or immediate surrounding metal surfaces with your bare hands while grilling.
6. Use an insulated glove or mitt when opening and operating the grill. Always open the grill lid slowly to allow heat and smoke to escape before fully opening.
7. The grill hood must be fully opened while lighting the grill. Releasing fuel into a closed grill before lighting will not make it light sooner or more efficiently. It will only risk explosion and personal injury or death. Never lean over a hot grill surface or look directly into the grill when attempting to light.
8. Do not heat unopened food containers as pressure build-up will cause the container to explode.
9. Do not use aluminum foil to line grill racks or drip pans. This will alter the airflow or trap excessive heat in the control area and can melt control knobs and ignition modules. Such damage is specifically excluded from your warranty.
10. Never use charcoal or any other solid fuel in the grill.
11. Cooking excessively fatty meats and oils will cause flare ups. Internal fires or damage caused by them or by the grill being left unattended while cooking are not covered under the terms and conditions of our warranty.
12. Never grill without the drip pan in place. Always ensure the drip pan is pushed all the way to the back of the grill. Hot grease can leak downward and produce a fire or explosion.
13. Grease is extremely flammable. Let hot grease cool down before attempting to handle or dispose of it. The drip tray should be cleaned of grease on a regular basis.
14. Do not use the grill unless a leak check has been performed on all gas connections. (See INDEX: "Leak Test Procedure" for further details.)
15. Never operate the grill while under the influence of alcohol or drugs.
16. Do not lean on side shelves and never place a load weighing more than 25 pounds on a side shelf.
17. If any burner does not light or goes out during operation, turn off all gas control knobs, open the hood and wait five (5) minutes before attempting to re-light.
18. Portable L.P. cylinders: Always shut off the main valve on the L.P. cylinder after each use.
19. Spiders and insects like to nest in the burners, venturis, valves and orifices of a grill, disrupting the gas flow. This very dangerous condition can cause a fire behind the control panel, damaging the grill and risking personal injury. If your grill has been unused for a long time, inspect and clean the burners, venturis, valves and orifices. (See INDEX: "Cleaning the Brass Burner" for further details.)

## GRILLING IN WINDY CONDITIONS

Outdoor grills create more heat than interior kitchen ranges. That's how they sear and grill steaks and other foods.

These high-performance burners require a constant, steady supply of fresh air to mix with the fuel. Your grill pulls air in



Air enters through the front of the grill.

through the front and vents hot gases out through the rear.

Using your grill in windy conditions may disrupt the front-to-back air flow. If, while grilling with all burners on high and the hood closed, you notice that the temperature gauge fails to rise ... be careful. If wind has kept hot gases

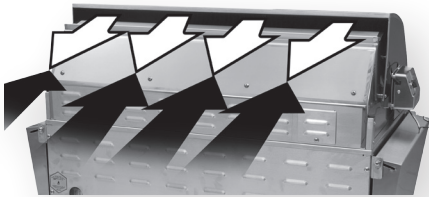

Wind hitting the back of the grill can disrupt proper exhaust.

from exiting the rear of the grill the control panel and knobs may have become extremely hot.

Your grill features an exclusive, patent-pending Heat Stabilizer that will deflect wind and, in most cases, prevent this situation.

But there are a few things you can do to further **prevent the possibility of improper heat buildup:**

- On breezy days, be careful not to leave the front hood down for more than 15 minutes when the burners are on high. (Never leave the grill unattended when in operation)

- If you suspect the grill is overheating, using an oven mitt, open the front hood. Then adjust the burner control knob to a lower setting.
- Install your grill with a wind break behind it.
- Orient the grill so prevailing winds are not blowing into the rear of the grill.

***Please Note: Any damage caused from use in windy conditions, such as melted knobs or igniter wires, or control panel discoloration from heat buildup, is excluded from warranty coverage.***



---

## USING YOUR GRILL

---

Grilling requires high heat for searing and low, controlled heat for slow cooking.

Thinner cuts of food are often cooked at a “HI” heat setting with the lid open.

On the other hand, large, thick pieces of meat or poultry are often first seared at the *high* setting and then grilled at a *lower setting* ... sometimes with the lid closed ... achieving the best results in the middle of the food without burning the outside.



### Main Brass Burner

This heavy-duty, durable brass burner is the standard main burner found under the briquette trays.

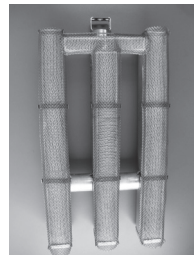

### ProSear™ 2 Burner

This advanced infrared burner provides high-intensity infrared heat for searing foods and sealing in flavor.

Some foods are cooked using direct heat and some using indirect heat.

Your grill features a variety of professional-level burners and tools for meeting the wide variety of cooking challenges. We will reveal how these features work for you. So please read and enjoy!

Depending on the model you chose, your grill may be equipped with up to three different burner types. The operation of each type varies, so it is important to understand all three.



### Rotisserie Burner

This infrared burner spans the back of the cooking surface and provides consistent heat for slow rotisserie cooking.

---

## PRE-GRILL CHECKLIST

---

### BEFORE YOUR *FIRST USE*

---

There are a few must-check safety precautions to consider before you use your grill. Please be sure that:

- All packing materials and tie-downs have been removed from the burners. (See INDEX: “Unpacking & Assembly” for further details.)
- You have fuel connected. (See INDEX: “Gas Requirements” for further details.)
- You have electric connected. (See INDEX: “Electric Requirements” for further details.)
- A qualified plumber has performed a leak test on all the fittings that supply fuel to your grill.

- **IF YOUR GRILL DOES NOT LIGHT IN 4 TO 5 SECONDS** you may need to purge the line. (See INDEX: “Purging the Gas Line”)

### AT EACH NEW SEASON

---

At the start of each new grilling season you should remove the grilling racks and check the burners, venturis, orifices and valves for obstructions.

Spiders and insects often nest in these areas of the grill and can disrupt air flow, causing damage to the grill and personal injury.

Also, check all hoses and fittings for damage, abrasion, wear and tear.

## PRE-GRILL CHECKLIST ...continued

### BEFORE EACH USE

Before any use, always make sure that:

- ... you do not smell gas before you light the grill. If you do smell gas, shut everything off and have a qualified plumber check for leaks.
- ... the cooking area is free and clear of any combustibles, besides your food, that might ignite.
- ... the control knobs turn freely.
- ... if you are using a portable propane cylinder, it is securely connected and leak tested. (See INDEX: "Cylinder Retention Instructions" for details.)
- ... you know where the main gas supply shut-off is located.
- ... the burners are seated properly in the grill. The main burners must sit level and firmly on the burner mounting support frame. (See INDEX: "Unpacking & Assembly" for further details.)
- ... wind is not blowing too strongly or blowing on the back of grill.

## LIGHTING YOUR GRILL



### WARNING

1. Never attempt to light a burner if you smell gas.
2. Always keep the lid open (side-burner lids must be completely removed) when lighting your grill.
3. Releasing fuel into a closed grill before lighting will increase the risk of explosion, property damage, personal injury or death.
4. Keep your face and body as far from the grill as possible when lighting. Any time a burner doesn't light within 5 seconds, turn off the control, wait 5 minutes for gas to dissipate, and repeat the lighting procedure.
5. YOU NEVER LEAVE THE GRILL UNATTENDED WHILE COOKING.

### ELECTRIC IGNITION

Before proceeding, make sure you have completed the "Before Each Use" checklist.

Follow these steps to light any of the burners on your grill:

First, make sure all burner control knobs are set to OFF.



#### For the Main Brass Burner or ProSear™ 2 Burner:

Push and hold the control knob in for 5-7 seconds, allowing the igniter to heat up. Then rotate the knob to "LITE". After ignition, set the knob to the desired heat setting.

#### For the Rotisserie Burner:

The rotisserie burner features a thermocouple sensor with a safety valve that automatically shuts off the flow of gas if the burner goes out. (See INDEX: "Windy Conditions" for tips on how to prevent burner blow out)

To light the rotisserie burner, push and hold the control knob in for 2 seconds and then turn the knob to the "LITE" position.

After ignition CONTINUE HOLDING THE CONTROL KNOB IN for 30 to 60 seconds. During this time the thermocouple will heat up and the safety valve will remain open.

If you release the control knob before the thermocouple has heated up, the safety valve will shut off the flow of gas to the rotisserie burner and you will have to re-light the burner.



## LIGHTING YOUR GRILL ...continued



### COLD WEATHER WARNING: PROPANE

Extremely cold temperatures may cause your ProSear™ 2 burners to light *inside* the burners instead of *outside*. Once lit, if you hear a 'whooshing' sound, immediately turn the burner knobs off to extinguish the flame and then immediately re-light the burners.

### MANUAL LIGHTING

If a burner doesn't light after several attempts, it can be match lit using the lighting rod stored in the drip tray.

Match-lighting your grill is done in one of three ways, depending upon which burners are being lit.

First, make sure you've returned all of the control knobs to the OFF position and have allowed 5 minutes for any accumulated gas to dissipate before attempting to match light a burner.

#### Manual Lighting Tube

Your grill features individual manual lighting tubes for all main burners except for the right-most main burners.

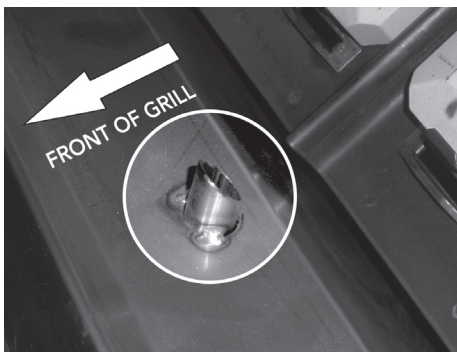

Using the lighting rod, place a lit match in front of the manual lighting tube for the burner you wish to light. (See photo)

Push and turn the corresponding burner control knob to "LITE". If the burner doesn't light within 5 seconds turn the knob off and wait 5 minutes before attempting to light it again. Once lit, gas will stop flowing through the manual lighting tube.

#### Right-Most Main Burner

The right-most main burner does not feature a manual lighting tube.

To match-light this burner, use the lighting rod to insert a lit match through the cooking grate into the front slot of the briquette tray for that burner.

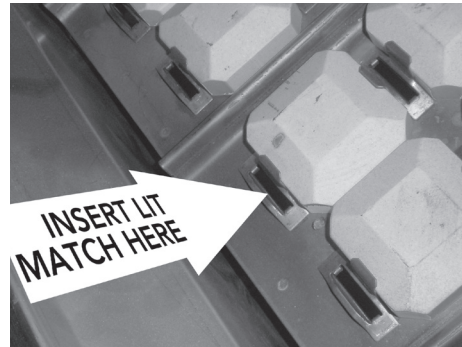

Push and turn the corresponding burner control knob to "LITE". If the burner doesn't light within 5 seconds turn the knob off and wait 5 minutes before attempting to light it again.

#### ProSear™ 2 Burner

The ProSear™ 2 burner does not feature a manual lighting tube.

To match-light this burner, use the lighting rod to insert a lit match through the cooking grate and through the protective screen.

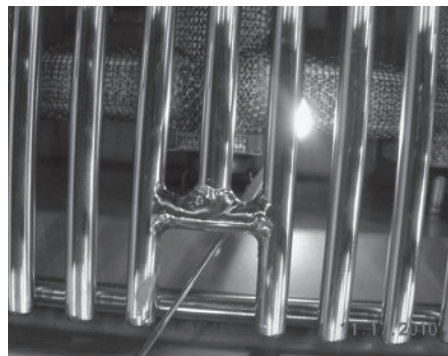

Push and turn the corresponding burner control knob to "LITE". If the burner doesn't light within 5 seconds turn the knob off and wait 5 minutes before attempting to light it again.

# BASIC GRILLING

## PRE-HEATING

Pre-heating your grill every time you use it is extremely important. Pre-heating allows the briquettes to properly heat up, providing more even and more consistent cooking results.

Pre-heat your grill by igniting all main burners, including the ProSear™ 2 burner, and setting them to "HI".

Then close the hood and allow the grill to heat for 10 to 15 minutes. Once you've reached your desired pre-heat temperature, turn off the burners that you won't be using to cook your food.



### WARNING!

DO NOT LEAVE THE GRILL UNATTENDED DURING THE PRE-HEAT CYCLE OR AT ANY TIME WHILE THE GRILL IS IN USE.

PRE-HEATING FOR MORE THAN 15 MINUTES MAY OVERHEAT THE GRILL, CAUSING DAMAGE TO THE GRILL.

## TYPES OF COOKING

The main brass burners and the ProSear™ 2 burner in your grill are capable of creating a range of heat intensities. By varying the heat output, the number of burners used and the position of the hood, you can create either direct or indirect heat or a combination of both and develop a wide variety of succulent recipes. There are two basic types of grilling in an outdoor grill... *Direct Heat and Indirect Heat*

### Direct Heat

Direct heat cooking occurs when foods are placed directly over the heat source. This form of heat is known as "radiant" heat because the heat radiates directly from the source to the food.

Direct heat is a must when you want to sear the outside of your food to seal in flavor. ProSear™ 2 Burners provide the heat necessary to sear foods and seal in flavor.

### Indirect Heat

Indirect heat cooking occurs when the food is not close to the heat source. Heat reaches the food via air movement within the cooking area. This form of heat is known as "convection" heat.

Indirect, or "convection" cooking is achieved by placing the food on one side of the grill and igniting burners on the other side. You leave the burner below the food "OFF". You should keep the hood closed as much as possible during this type of cooking to maintain even heat around the food. You regulate the heat by adjusting the burner, using the hood thermometer to monitor the temperature.

## USING THE PROSEAR™ 2 BURNER

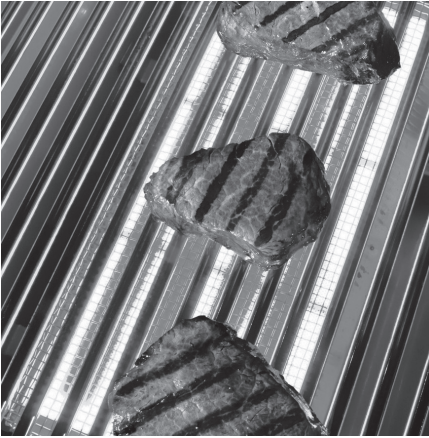

Professional restaurant chefs rely on a different type of heat ... infrared heat ... to create a higher searing temperature than what standard burners can achieve. Viking Range, LLC provides the ProSear™ 2 infrared burner.

Infrared burners work by focusing the gas flame through a ceramic element filled with tiny holes.

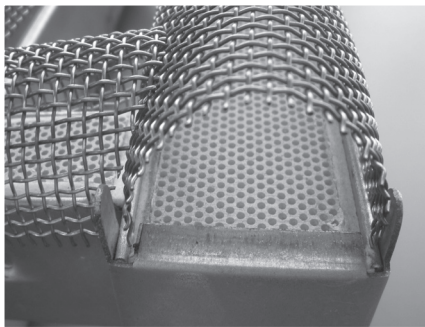

These holes focus the flame on the surface of the element, creating an intense heat much higher than that of a standard brass burner. It allows you to sear your food more quickly while leaving the inside rare, if desired.

The ProSear™ 2 burner, with its advanced components, requires particular attention to lighting, usage and cleaning guidelines. See INDEX: "ProSear™ 2" for further details.

### Pre-Heating the ProSear™ 2 Burner

Always preheat the entire grill before cooking to achieve consistent, successful results. (See INDEX: "Preheating" for further details.)

If the grill is already hot from cooking you should still pre-heat the ProSear™ 2 burner for 2-3 minutes, or until it glows red.

Never place food over a ProSear™ 2 burner before it is fully pre-heated because food particles and grease dripping onto a cold ProSear™ 2 burner can clog the tiny ports and damage the burner.

For the same reason you should minimize water spills on the ProSear™ 2 burner and should not use water to control flare-ups. Take special care to minimize dropping any liquids on the ProSear™ 2 burner while cleaning the cooking grids.

### HOW TO SEAR

Searing locks in flavor and juices while allowing the food's outer surface to absorb smoke and food-born aromas produced when drippings are vaporized by the burner.

The result is a restaurant-style finish ... crisp, flavorful outside with a tender, juicy inside.

While the brass burners in your grill are capable of producing searing heat, the ProSear™ 2 infrared burner is specifically designed for this purpose.



### SAFETY PRECAUTIONS

Grill cooking grids are heavy duty. Dropping them on the ProSear™ 2 Burner will damage the burner. Such damage is not covered by the product warranty and will cause a fire, burns or other personal injury.

### PROSEAR™ 2 CLEANING

It's easy to keep your ProSear™ 2 Burner operating at peak performance. Just run it on "HI" with the hood open for 15 minutes after each use to burn away any food particles or drippings.

Any ash accumulation on the burner screen can be removed with a light brush (like a paint brush) or vacuum ... BUT WAIT UNTIL THE BURNER IS COOL!

# USING THE ROTISSERIE BURNER

Rotisserie cooking provides an even delivery of heat to your foods. It has no equal.

The constant rotation not only cooks foods evenly, it also self bastes. As juices rise to the surface of the food, they naturally flow around it as it rotates. And, by moving the burner out from beneath the food, you avoid scorching flare-ups.



Your foods will be more evenly cooked, more tender and juicier when slow-roasted on a rotisserie.

The rotisserie system consists of four main parts, the motor, the skewer, the forks and the infrared burner.

## The Motor

Install the motor by sliding it into one of the slots shown here. Use the top slot for small foods or fast cooking and the lower slot for large foods and slower cooking.



Plug the motor power cord into the

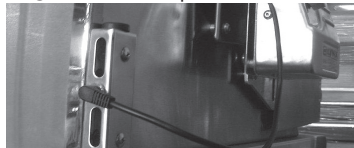

motor and into the built-in power outlet on the rear left panel. Your grill must be plugged into an AC power supply for the rotisserie to work.

Place a basting pan in the grill to prevent food accumulations on the briquettes and burners. But **BE SURE YOU REMOVE IT** before using any of the other burners.

The location of the rotisserie burner makes it more susceptible to strong wind conditions (more so than the main grill burners).

For this reason it features a safety valve that automatically closes any time the rotisserie burner is not properly lit ... like if it were to extinguish in windy conditions. During windy conditions, it's best to keep the lid closed and to periodically check the burner.

When the rotisserie is not in use the rotisserie motor should be stored in a cool dry location.

## The Skewer & Forks



The rotisserie can handle large food items up to 50 lbs. You should prepare any item and first mount it on the skewer.

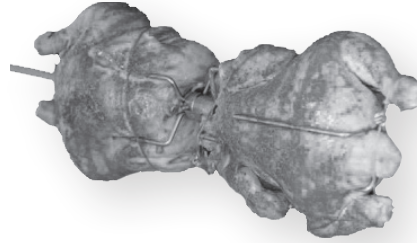

Swing the warming rack up and out of the way. It will rest in place.



Then mount the skewer on the grill before lighting the rotisserie infrared burner. Lighting the burner first could result in burning your hands while trying to mount the skewer on the grill.

It's okay to remove the grill racks and even the briquette trays to make room for large foods on the skewer.

To load the skewer, slide one of the forks onto the skewer. Push the skewer through the center of the food, then slide the second fork onto the skewer. Center the food to be cooked on the skewer then push the forks firmly together. Tighten the thumb screws (use pliers if necessary). You should wrap any loose, dangling pieces of food (like wings) with butcher's string (never use nylon or plastic string).

With the food secured to the skewer slowly roll the skewer in the palms of your hands to check for balance. It should rotate smoothly. If you find it has a heavy side, adjust where the skewer pierces the meat. An unbalanced skewer will cause uneven rotation and uneven cooking. It's normal for the skewer to flex with large foods.



## USING THE ROTISSERIE BURNER ...*continued*

Slide the pointed end of the skewer into the motor and rest the other end on the rollers on the other side of the grill.

The notched portion of the skewer must rest on the rollers for proper operation.



Must rest  
on rollers

### The Rotisserie Burner



To light the rotisserie infrared burner, first mount the skewered food item on the grill then follow the rotisserie lighting procedure. (See INDEX: "Rotisserie Burner, Lighting" for further details.)

Once lit, the rotisserie burner should reach cooking temperatures in about 1 minute. It will glow evenly across its surface in about 5 minutes.

NOTE: The grill thermometer should not be used for rotisserie cooking. It is not designed to read direct infrared heat.

If the burner will not stay lit when you release the control knob, re-light it and hold the control knob in for at least 60 seconds to allow the thermocouple to heat up.

If, after holding the control knob in for at least 60 seconds, the burner still will not stay lit when releasing the control knob, call for service.

(See INDEX: "Obtaining service" for further details.)

Shut off all other burners while using the rotisserie burner.

## USING THE SMOKER BOX

Professional chefs far and wide set their restaurant cuisine apart by cooking over wood fires.

Imparting a delicate hint of wood smoke enhances food, raising your culinary skills to the next level.



Your new grill comes with a new smoker set with handle.

This oval shaped smoker box can be placed anywhere on the grates directly over any burner. The unique handle and interlock mechanism is designed to allow quick removal or refilling of the smoker box.

The smoker box is designed with special draft and flow through for maximum smoke. It is constructed of 304 Heavy Gauge Stainless Steel for years of use.

The smoker box can be used with smoker pellets or wood chips. Whether using wood chips or pellets, we recommend using approximately 3 oz. of either material. There is no need for presoaking, just fill the smoker box.

Now use the handle to place the smoker box directly on the hot grates. Don't forget to remove the smoker handle before closing the grill lid.



Smoke occurs at approximately 575 degrees F. at the grilling surface. Set the burner knob to medium/medium low to achieve this temperature. Use the handle to move or refill the smoker box. Control the smoking by adjusting the heat and being careful not to adjust it too high.

For best results keep the lid closed. The best absorption of smoke flavor occurs early in the cooking process. When finished with smoking, allow the smoker box to cool and dispose of remnants.

### CAUTION

Handle the smoker box with care. The cover becomes extremely hot when in use. Use sturdy, properly insulated gloves or dry pot holders.

# CLEANING YOUR GRILL

## STAINLESS STEEL

Our products are known for their attractive appearance. We achieve this by selecting only the finest grades of stainless steel and applying exacting workmanship.

In order to maintain this attractive appearance over the life of the grill it is important to take the following steps:

- After each use wipe down the exterior of the grill to remove grease and splatters.
- Be sure to follow the cleaning instructions for keeping the grates and burners clean and ready for use.
- Use a commercially available Stainless Steel cleaner to clean and polish the exterior surfaces.

Doing these things on a regular basis minimizes the amount of effort required.

Part of the appeal of your Grill is the fine grain finish. When removing stubborn stains:

- Do not use metallic abrasives and always rub in the direction of the grain.



- Some household cleaning products are not suitable for stainless steel; be sure to read the label before using on your Grill.
- Always use the mildest cleaning solution first, scrubbing in the direction of the grain. Specks of grease may gather in the grain of the stainless steel and bake on to the surface, giving the appearance of rust.

To remove these baked-on foods use a fine to medium grit non-metallic abrasive pad (Scotch Brite is good) in conjunction with a stainless steel cleaner.

- **Solutions used for cleaning concrete and masonry can be very corrosive and will 'attack' stainless steel. Ensure your products are well protected before you allow the use of such chemicals near your grill.**

## SPECIAL NOTE FOR LOCATIONS NEAR POOLS AND COASTAL AREAS:

The 304 stainless steel material used in the construction of the grill is highly rust resistant, however, chlorine in the air from swimming pools or the salt from sea air may cause surface rust to appear and even create some pitting if left on the product.

Here are a few tips to avoid this:

- Regularly wipe down the exterior surfaces with a damp cloth. (Micro fiber cloths perform very well).
- Allow the surfaces to dry before installing the cover. Do not cover a damp grill.
- In extreme environments apply a rust inhibitor which leaves a microscopic protective layer on the grill. Products that provide a layer of vapor corrosion inhibitors (VpCI™) protect the surface very well.
- For seasonal storage use the product referred to above, ensure the grill is dry and then cover and secure the cover to minimize the amount of damp air getting to the surfaces.

THE LIMITED LIFE TIME WARRANTY PROVIDES PROTECTION AGAINST RUST THROUGH OF PARTS THAT RENDER THE PRODUCT INOPERATIVE. IT DOES NOT COVER OCCASIONAL SURFACE RUST OR STAINING DUE TO ENVIRONMENTAL CONDITIONS.

After your first use certain areas of the grill may discolor from the intense heat given off by the burners - this is normal and cannot be cleaned off.

For light and heavy food stains there are many different stainless steel cleaners available.

## DRIP TRAY

The drip tray should be cleaned after each use. After the grill is completely cool, remove the drip tray by pulling it out until it stops, then lifting the front edge until the drip tray comes free.

Clean it with hot soapy water or an oven-style cleaning product and re-install. When using an oven-style cleaning product be sure to carefully follow the manufacturer's instructions. Many of these cleaners are toxic and can damage the stainless steel finish if not used properly.

Also, check the tray after rain. If you've left the grill uncovered, you may need to remove the drip tray drain plug to drain the water from the tray. The drain plug can be removed with a flat-head screwdriver.

## CLEANING YOUR GRILL ...continued



### WARNING

DO NOT ALLOW EXCESS GREASE OR LIQUIDS TO ACCUMULATE IN THE DRIP TRAY AS THIS MAY CREATE A FIRE HAZARD.

NEVER USE GRILL WITHOUT DRIP TRAY PROPERLY INSTALLED.

### GRILLING RACKS

The easiest way to clean the grill racks is to do so immediately after turning off the burners, while they are still hot. Wearing a long BBQ mitt to protect your hand from steam, dip a brass bristle brush in hot water and scrub the grill rack. Dip the brush frequently because the steam helps remove baked-on foods.

### CERAMIC BRIQUETTES

The ceramic briquettes normally burn off any accumulated food drippings. But you may occasionally experience larger spills that don't burn off under normal use.

When this happens, let the grill cool completely. Remove the racks and then the briquette trays by lifting the front edge and pulling them toward you.



Flip the trays over and put them back in place over the burner. Light the burners and set them to "HI" for 5 - 10 minutes to burn the briquettes clean. Any remaining food items can be brushed off using a soft brush.

Be sure the trays have completely cooled before reinstalling them.

Replacement briquette trays can be ordered from your dealer.

### MAIN BRASS BURNERS

Make sure the grill is completely cool before proceeding.

Ensure that the gas supply is off and all control knobs are in the "OFF" position.

### To Remove Brass Burners:

Remove the grill racks and briquette trays.

Lift the burner up until the legs exit the frame.

Then pull to the rear of the grill so the burner head comes off the brass orifice at the front.

Angle the burner sideways and lift it out.

Be careful not to change the air shutter position.

### To Clean the Brass Burner:

To maximize grill performance, clean the exterior of the burner with a wire brush. Remove stubborn scale with a metal scraper.

Clear any clogged ports with a straightened paper clip. Never use a wooden toothpick as it may break off and clog the port.

Shake out any debris through the air shutter.

Use a flashlight to inspect the burner inlet to ensure it is not blocked. If obstructions can be seen, clean it with a paper clip or a pipe cleaner.



### WARNING

PROPER PLACEMENT OF EACH BURNER IS CRITICAL. AFTER CLEANING THEY MUST BE CENTERED ON THE BRASS ORIFICE, RESTING LEVEL WITHOUT ANY ROCKING.

FAILURE TO MEET THESE CONDITIONS MAY CAUSE A VERY DANGEROUS CONDITION THAT CAN CAUSE PERSONAL INJURY AND PROPERTY DAMAGE.

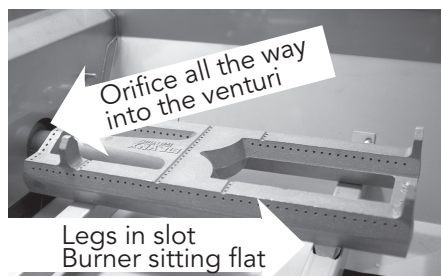



## CLEANING YOUR GRILL ...continued

### PROSEAR™ 2 BURNER

It's easy to keep your ProSear™ 2 burner operating at peak performance. Just run it on "HI" with the hood open for 5 minutes after each use to burn away any food particles or drippings.

Any ash accumulation on the burner screen can be removed with a light brush or vacuum ... BUT WAIT UNTIL THE BURNER IS COOL!

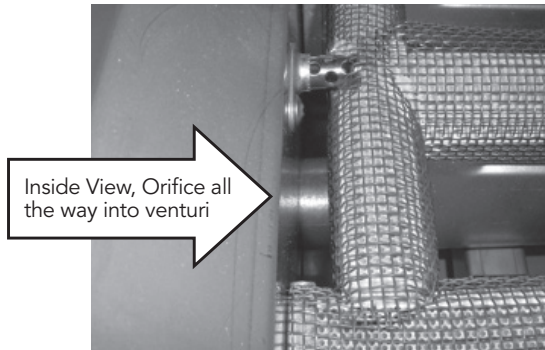

Every 3 to 6 months, remove the burner and inspect the venturi (inlet) and orifice to ensure that they're free of obstructions.

Food debris on the inside of the burner can be gently shaken out. Do not touch the ceramic surface.

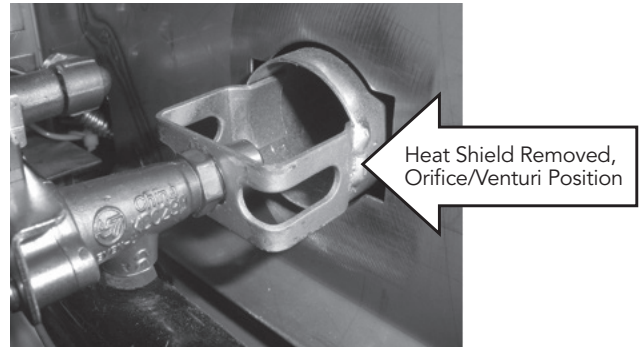

When re-installing the ProSear™ 2 burner, be sure to correctly position the burner.

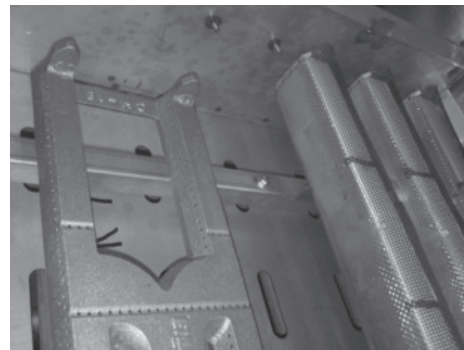

## TROUBLESHOOTING YOUR GRILL

### BEFORE YOU CALL FOR SERVICE

Please check a few things before calling for service:

- Is there fuel supplied to the grill?
- Is the main shut-off valve open?
- Are you using the correct type of fuel? (LP or Natural Gas) (See INDEX: "Gas Requirements" for further details.)

- Is your propane cylinder empty? Have you recently refilled the propane cylinder? If so, is the connection tight?
- Have you opened the valve on the propane cylinder?
- Is the grill plugged in to a live electric circuit?

If you've checked the above items, review the trouble-shooting list below before calling for service.

# POTENTIAL PROBLEMS

## GRILL WON'T LIGHT

First, confirm that the grill is getting electricity by turning on the lights, then:

### Check The Igniters

Your grill uses an electric ignition system that does not spark. Instead, the igniters should glow constantly when a control knob is pushed in.

- Ensure that all burner controls are set to OFF.
- Remove the cooking grates and briquette trays.
- Watch an igniter as you push in and hold the corresponding control knob. You will need either a small mirror or shiny metal object to see the igniter under its cover.  
(Be sure you push in the correct control knob and keep

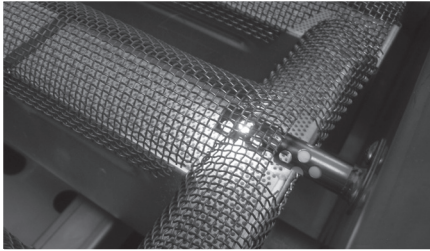

the knob in the "OFF" position).

- Check the remaining igniters. If igniters don't glow, proceed with troubleshooting or match-light the burner.

### Check The Burners

If the igniters are working check to see if gas is reaching the burners by attempting to match light a burner.

**BE CAREFUL! IF THE BURNER FAILS TO IGNITE, WAIT 5 MINUTES BEFORE ATTEMPTING TO IGNITE OTHER BURNERS!** (See INDEX: "Match Lighting" for further details.)

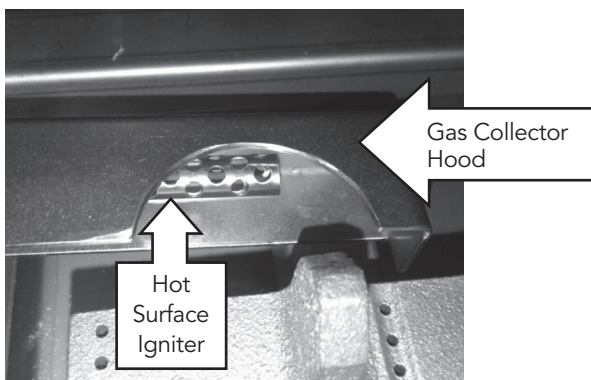

If match lighting doesn't work, re-check fuel connections for leaks and ensure the supply is of the correct type and is of adequate pressure. (See INDEX: "Leak Test Procedure" for further details.)

If the burner will light with a match, then the igniter may not be functioning correctly. Call for service.

If the burner will not match light, and you know you are getting gas, wait for any gas to dissipate and remove the burner and check it for blockages.

## SMELL OF GAS WHILE COOKING

**IF YOU SMELL GAS WHILE THE GRILL IS OPERATING, IMMEDIATELY TURN OFF ALL BURNERS AND SHUT OFF THE MAIN FUEL SUPPLY.**

- Perform a leak test (See INDEX: "Leak Test Procedure" for further details.)
- Check for blockages (See INDEX: "Clean the Brass Burner" for further details.)

## YELLOW FLAMES

A yellow flame on the main burners indicates a lack of air. But, if the air around the grill is dusty or if heavy grease is present, some orange tips on the burner flame are normal.

- Adjust The Air Shutter

To adjust for insufficient air, adjust the air shutter. (See INDEX: "Air Shutter Adjustment" for further details.)

## LOW OR INSUFFICIENT HEAT

No part of the grill should ever be lined with aluminum foil. Doing so will interfere with airflow and can cause a low heat condition.

Ensure that you've preheated the main burners for at least 10 to 15 minutes with the hood closed and the ProSear™ 2 burner for 3 minutes.

Proper leveling during installation is critical. A grill that is out of level will cause erratic burner combustion and inefficient, uneven heating. A carpenter's spirit level should be used to level the grill both front-to-back and side-to-side.

### If the low heat problem persists:

- Check the gas supply line sizing requirements.
- Check the gas supply line for kinks or damage.

## POTENTIAL PROBLEMS ...continued

REPLACE any damaged supply lines.

- Check the Regulator

Make sure that the regulator & hose assembly is the one designed for and supplied with your grill and that it is correctly set up for the type of fuel you are using. (See INDEX: "Regulator Conversion" for further details.)

The hose and regulator provided must be used if your grill is set-up for an LP Gas Cylinder.

Check that there is no physical pressure being applied to the regulator attached to the back of the grill. The regulator contains a flexible diaphragm and should not be allowed to touch the grill body or its surroundings.

- Check for Obstructions

Ensure that the burners and drip tray are clean and free from obstructions.

### **LP (Propane) units:**

- Is the cylinder almost empty?

Almost-empty cylinders may not have sufficient pressure to run the burners at high heat.

- Have the line pressure checked by a qualified technician (See INDEX: "Gas Requirements" for further details.)
- Flow Limiting Device

Improper lighting procedures may have activated the LP cylinder's flow control device, reducing the heat output.

### **To reset the flow control:**

- Shut off all burner controls and close the LP cylinder valve.
- Wait 30 seconds and, very slowly, reopen the cylinder valve.
- Wait a few seconds and relite a burner.

### **Bulk LP cylinder users:**

Bulk LP cylinder lines must be properly regulated.

Ensure that you are using a 4/11 appliance regulator supplied by Viking Range, LLC and converted to LP gas. Also ensure that you do not have more than one regulator in line.

### **Natural Gas units:**

- Supply Line

Ensure that the supply line is at least 3/4" inside diameter or 1" outside diameter.

- Check line pressure

Natural gas inlet pressure should be at least 5" W.C. and manifold pressure not less than 4" W.C. under full load (with all burners on.)

- Check burners for blockages.
- Check flame characteristics. (See INDEX: "Flame, Correct Size" )
- Clean or adjust air shutter (See INDEX: "Air Shutter Adjustment."

## WIND HITTING GRILL

Wind hitting the grill while in use, especially winds blowing into or across the hood gap from behind, can cause poor performance and in some cases can cause the control panel to get dangerously hot.

Steady or gusty winds can prevent the normal exhaust of hot gases. Locate your grill **away** from prevailing winds and avoid grilling in windy conditions.

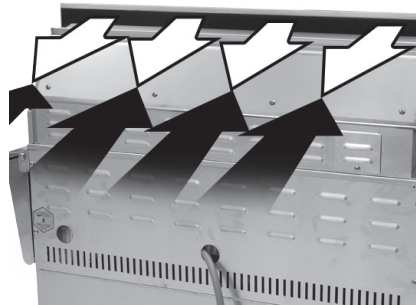

## POTENTIAL PROBLEMS ...continued

### BURNER GOES OUT

- Location

First determine if the problem is being caused by location. If the grill is subject to high winds, reposition it to provide some protection.

- Check the Flame

Check the gas supply and flame characteristics. (See INDEX: "Flame, Correct Size")

- Burners Seated

Check to ensure that the burners are correctly positioned in the grill. (See INDEX: "Burner Placement" for further details.)

Correctly-installed burners should be seated firmly and level with no side-to-side movement.

### BURNER GOES OUT ONLY WHEN SET TO "LOW"

The valves on the grill feature an adjustable low setting.

Fluctuations in gas pressure, gas conversion and even in the quality of the gas itself may affect burner performance at the "LOW" setting. It could be either too high or too low. (See INDEX: "Burner Adjustment" for further details.)

### ROTISSERIE WON'T LIGHT

Follow the same procedure as described for the grill burners to diagnose problems with the rotisserie burner.

BE CAREFUL! The rotisserie burner flame may be hard to see in bright sunny conditions.

### ROTISSERIE LIGHTS BUT GOES OUT AS SOON AS CONTROL IS RELEASED

- Check Thermocouple

The control knob must be held in for 30 to 60 seconds after ignition for the rotisserie burner to stay lit. (See INDEX: "Lighting Rotisserie Burner" for further details.)

If the burner will not stay lit when you release the control knob, re-light it and hold the control knob in for at least 60 seconds to allow the thermocouple to heat up.

If, after holding the control knob in for at least 60 seconds,

the burner still will not stay lit when releasing the control knob, call for service.

(See INDEX: "Obtaining service" for further details.)

### LIGHTS WON'T LIGHT

- Check Power

Ensure that the grill is connected to a live AC power source and check for rotisserie motor operation.

- Reset Transformer

Disconnect power from the grill and wait 5 minutes for the transformer to cool down and reset. Then reconnect power. If, after resetting the transformer and replacing bulbs, you still do not have power, call for service.

- Replace the Bulb

Replacement bulbs are halogen, 12 volt, 10W max, T3 type with a G4 bi-pin, and are readily available at most stores. The glass cover is held in place by two spring tension tabs. The bulbs are easily removable without the use of tools. Simply grasp the glass lens at the outer corners, near the front tension clips and push the lens back. Then, swing the lens down and pull it loose. You may have to loosen the screw to remove the lens.



Avoid touching the glass of a new bulb. Halogen bulbs are very sensitive to the oils found in human skin. Touching the

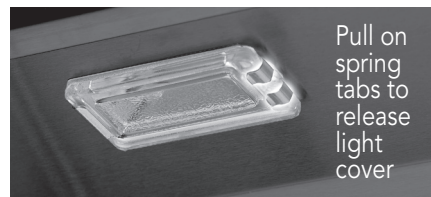

bulbs may shorten their life.

Pull the bulb straight out from the socket without twisting.

Hold the bulb using a paper towel or other cloth and gently press it straight into the socket. The glass cover should be gently snapped back into place.

---

## CONTACTING CUSTOMER SERVICE

---

Before calling Preferred Customer Service, please make sure you have the following information:

- Model number
- Date of purchase
- Proof of purchase by the original owner
- Serial number

The serial number can be located on the rating plate which is located on the underside of the drip tray and on the heat shield behind the front panel.

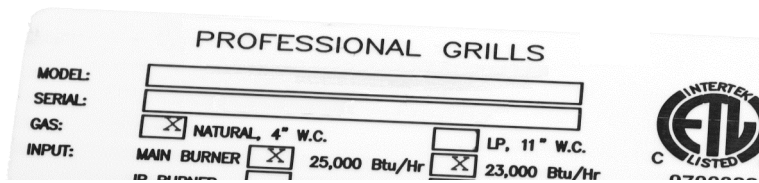

Your satisfaction is of the utmost importance to us. If a problem cannot be resolved to your satisfaction, please write, fax or email us:

Viking Range, LLC  
Preferred Customer Service  
111 Front Street  
Greenwood, Mississippi 38930

Service: (888) 845-4641

Tel: (662) 455-1200

[www.vikingrange.com](http://www.vikingrange.com) in the US or [www.brigade.ca](http://www.brigade.ca) in Canada

For warranty service, or for an authorized service agent near you, contact Preferred Customer Service at:

**(888) 845-4641**

[www.vikingrange.com](http://www.vikingrange.com) in the US or [www.brigade.ca](http://www.brigade.ca) in Canada



# VIKING RANGE, LLC LIMITED WARRANTY

## I. Limited Lifetime Warranty

The stainless steel grill body, brass grill burners, cooking grates, ProSear™ burner and rotisserie infrared burner are warranted to be free from defects in material and workmanship when subjected to normal domestic use and service for the lifetime of the original purchaser. This warranty excludes surface corrosion, scratches, and discoloration which may occur during normal use. This warranty is limited to the replacement of the defective parts, with the owner paying all other cost including labor, shipping and handling.

## II. Limited Five-Year Warranty

The following grill parts are warranted to be free from defects in material and workmanship, when subjected to normal domestic use and service, for a period of five (5) years from the original date of purchase; warming racks, spit rods, briquette trays, manifolds and gas valves. This warranty is limited to the replacement of the defective parts, with the owner paying all other costs including labor, shipping, and handling.

## III. Limited two-Year Warranty

All other grill components are warranted to be free from defects in material and workmanship, when subjected to normal domestic use and service, for a period of two (2) years from the original date of purchase. This warranty is limited to the replacement of the defective parts, with the owner paying all other costs including labor, shipping and handling..

## IV. Limited One-Year Warranty

For a period of one (1) year from the original date of purchase, Viking will replace or repair parts found to be defective at no cost to the original purchaser. This includes the cost of shipping replacement parts and, where necessary, service labor at prevailing local rates by a Viking authorized service person. Service will be provided during normal business hours and must be authorized in advance by Viking.

## IV. Limitations & Exclusions

- 1) This Warranty shall apply to products purchased and located in the United States and Canada. Products must be purchased in the country where service is requested.
- 2) Warranty applies only to the original purchaser and may not be transferred.
- 3) Warranty is in lieu of all other warranties expressed or implied and all other obligations or liabilities related to the sale or use of its grill products.
- 4) Warranty shall not apply and Viking Range, LLC is not responsible for damage resulting from misuse, abuse, alteration of or tampering with the appliance, accident, hostile environment, flare-up fires, improper installation, or installation not in accordance with the instructions contained in this manual, or the local codes.

- 5) Viking Range, LLC shall not be liable for incidental, consequential, special or contingent damages resulting from its breach of this written warranty or any implied warranty.
- 6) Some states do not allow limitations on how long an implied warranty lasts, or the exclusions of or limitations on consequential damages. This warranty gives you specific legal rights and you may have other rights which vary from state to state.
- 7) No one has the authority to add to or vary Viking's warranty, or to create for Viking any other obligation or liability in connection with the sale or use of its products.
- 8) Limited to the replacement of defective parts with the owner paying all other costs including labor.
- V. What is not covered: Viking Range, LLC shall not be responsible for and shall not pay for the following
  - 1) Installation or start-up, damages or problems caused by improper installation or use;
  - 2) Service by an unauthorized service provider;
  - 3) Damage or repair due to service by an unauthorized service provider or use of unauthorized parts;
  - 4) Warranty does not apply to products installed in any commercial or non-residential application. Examples of excluded applications include, but are not limited to day care centers, schools, bed and breakfast centers, churches, private clubs, fire stations, club houses, common areas in multi-family dwellings, restaurants, hotels, nursing homes, food service locations and institutional food service locations.
  - 5) To correct normal adjustments or settings, due to improper installation, commissioning or local gas supply properties.
  - 6) Shipping and handling costs, export duties, installation, removal, or re-installation cost.
  - 7) Display models are sold "as is". If you have purchased a display model, please be advised that it is sold "as is" and that it is subject to the following warranty exclusions: any exterior or cosmetic damage is nonwarrantable; any missing components will be replaced at consumers expense; major handling damage to manifold, valve and ignition system will be serviced at consumer's expense; all other warranty's (standard warranty) will remain in effect.
  - 8) The cost of a service call to diagnose trouble.

# VIKING RANGE, LLC COMMON AREA LIMITED WARRANTY

*The Viking Range, LLC Limited Warranty covers residential installations only and is non-transferable to any other party. This 'non-residential' warranty applies when the product is installed in common areas where more than a single party has rightful access to its use or in locations considered beyond normal residential use such as B&B's, and private clubs.*

## **THIS PROVISION EXCLUDES ALL COMMERCIAL APPLICATIONS, INCLUDING, BUT NOT LIMITED TO RESTAURANTS AND INSTITUTIONAL FOOD SERVICE LOCATIONS.**

### I. Limited Five-Year Warranty

The stainless steel body housings, the solid brass grill burners are warranted to be free from defects in material and workmanship when subjected to normal use and service for a five year period from the original purchase date. This warranty excludes surface corrosion, scratches, and discoloration which may occur during regular use. This warranty is limited to the replacement of the defective parts, with the owner paying all other cost including shipping, handling and labor.

### II. Limited One-Year Warranty

The structural integrity of the interior grill parts, exterior, and drip pans are warranted to be free from defects in material and workmanship, when subjected to normal domestic use and service, for a period of one year from the date of purchase. This warranty is limited to the replacement of the defective parts, with the owner paying all other costs including labor.

### III. Limited Parts & Labor Warranty

All other grill components are warranted to be free from defects in material and workmanship for a period of 90 days from the original date of purchase. Viking Range, LLC will replace or repair parts found to be defective at no cost to the original purchaser. After the 90 day period Viking Range, LLC will sell parts to the holder of this warranty at Viking Range, LLC contractor prices for an additional 9 months.

### IV. Limitations & Exclusions

- 1) This Warranty shall apply to products purchased and located in the United States and Canada. Products must be purchased in the country where service is requested.
- 2) Warranty applies only to the original location of installation and may not be transferred.
- 3) Warranty is in lieu of all other warranties expressed or implied and all other obligations or liabilities related to the sale or use of its grill products.
- 4) Warranty shall not apply and Viking Range, LLC is not responsible for damage resulting from misuse, abuse, alteration of or

tampering with the appliance, accident, hostile environment, flare-up fires, improper installation, or installation not in accordance with the instructions contained in this manual, or the local codes.

- 5) Viking Range, LLC shall not be liable for incidental, consequential, special or contingent damages resulting from its breach of this written warranty or any implied warranty.
  - 6) Some states do not allow limitations on how long an implied warranty lasts, or the exclusions of or limitations on consequential damages. This warranty gives you specific legal rights and you may have other rights which vary from state to state.
  - 7) No one has the authority to add to or vary Viking Range, LLC's warranty, or to create for Viking Range, LLC any other obligation or liability in connection with the sale or use of its products.
  - 8) Limited to the replacement of defective parts with the owner paying all other costs including labor.
- V. What is not covered: Viking Range, LLC shall not be responsible for and shall not pay for the following:
- 1) Installation or start-up, damages or problems caused by improper installation or use;
  - 2) Service by an unauthorized service provider;
  - 3) Damage or repair due to service by an unauthorized service provider or use of unauthorized parts;
  - 4) To correct normal adjustments or settings, due to improper installation, commissioning or local gas supply properties;
  - 5) Shipping and handling costs, export duties, installation, removal, or re-installation cost.
  - 6) Display models are generally sold "as is." If you have purchased a display model, please be advised that it is sold "as is" and that it is subject to the following warranty exclusions: any exterior or cosmetic damage is non-warrantable; any missing components will be replaced at consumer's expense; major handling damage to manifold, valve and ignition system will be serviced at consumer's expense; all other warranty's (standard warranty) will remain in effect.
  - 7) The cost of a service call to diagnose trouble.



# WIRING SCHEMATICS

## 30" ROTISSERIE GRILL

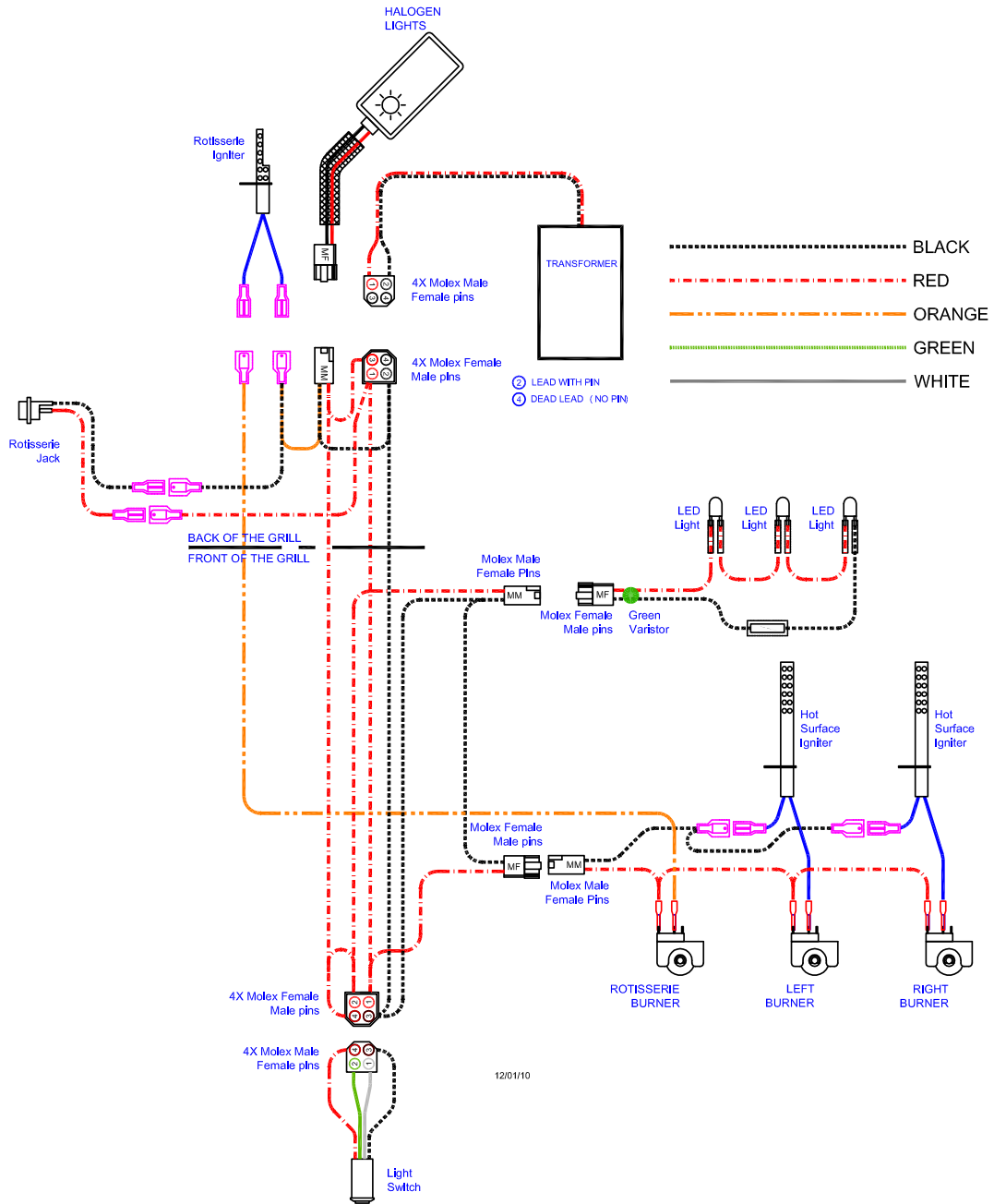

# WIRING SCHEMATICS

## 36" & 42" ROTISSERIE GRILL

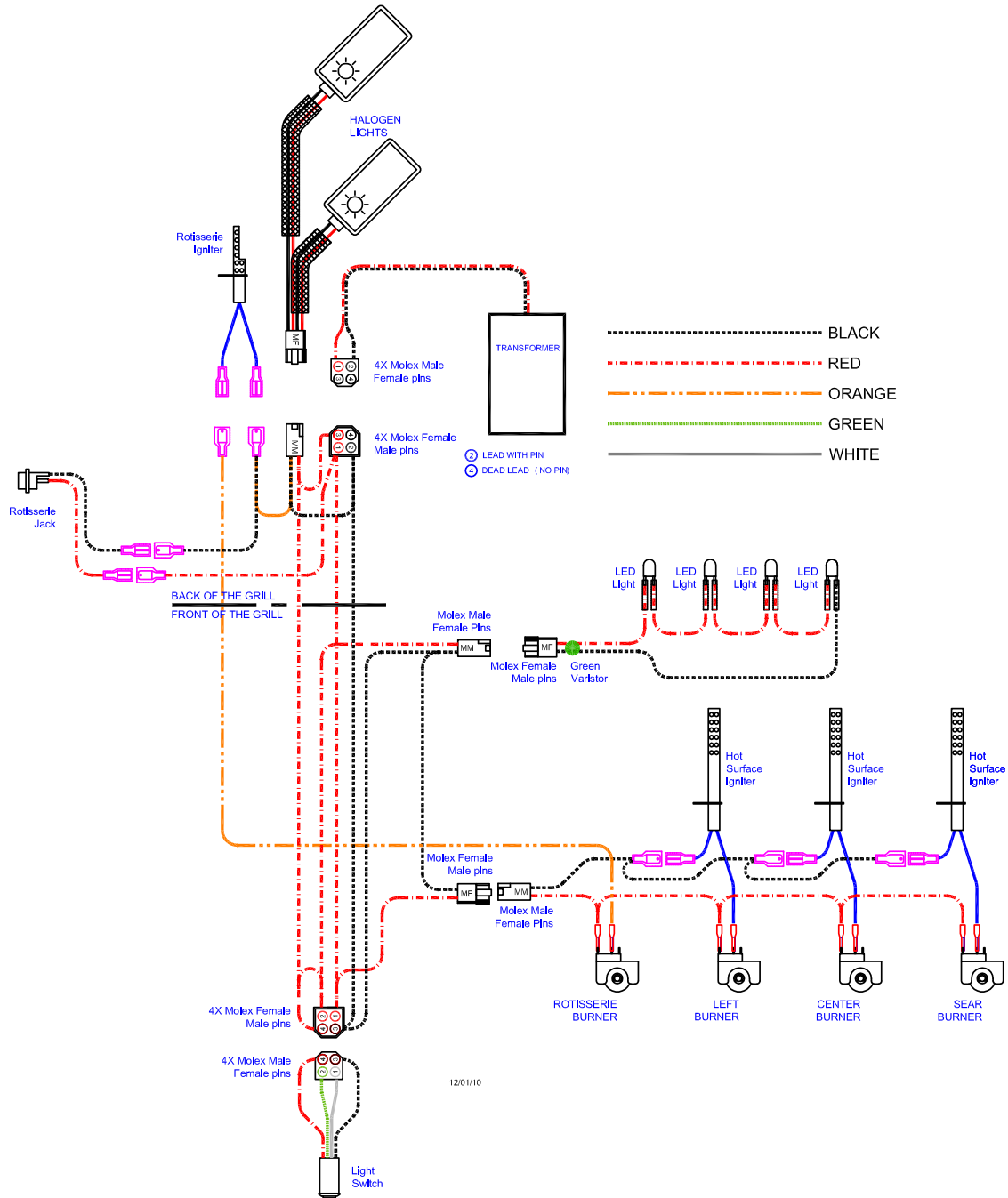

# WIRING SCHEMATICS

## 54" ROTISSERIE GRILL

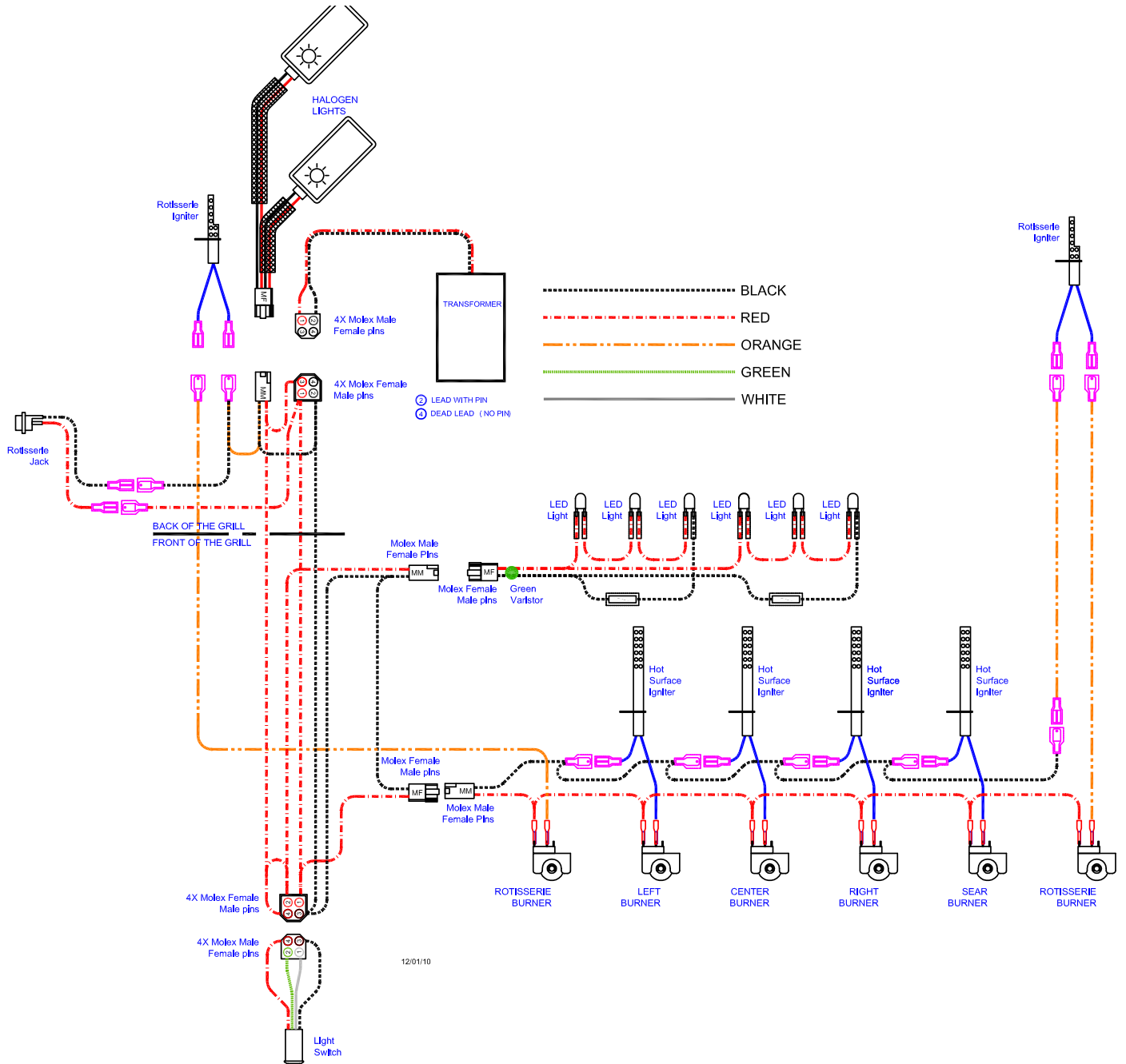

# PROFESSIONAL GRILLS EXPLODED PARTS VIEW

## PROFESSIONAL SERIES

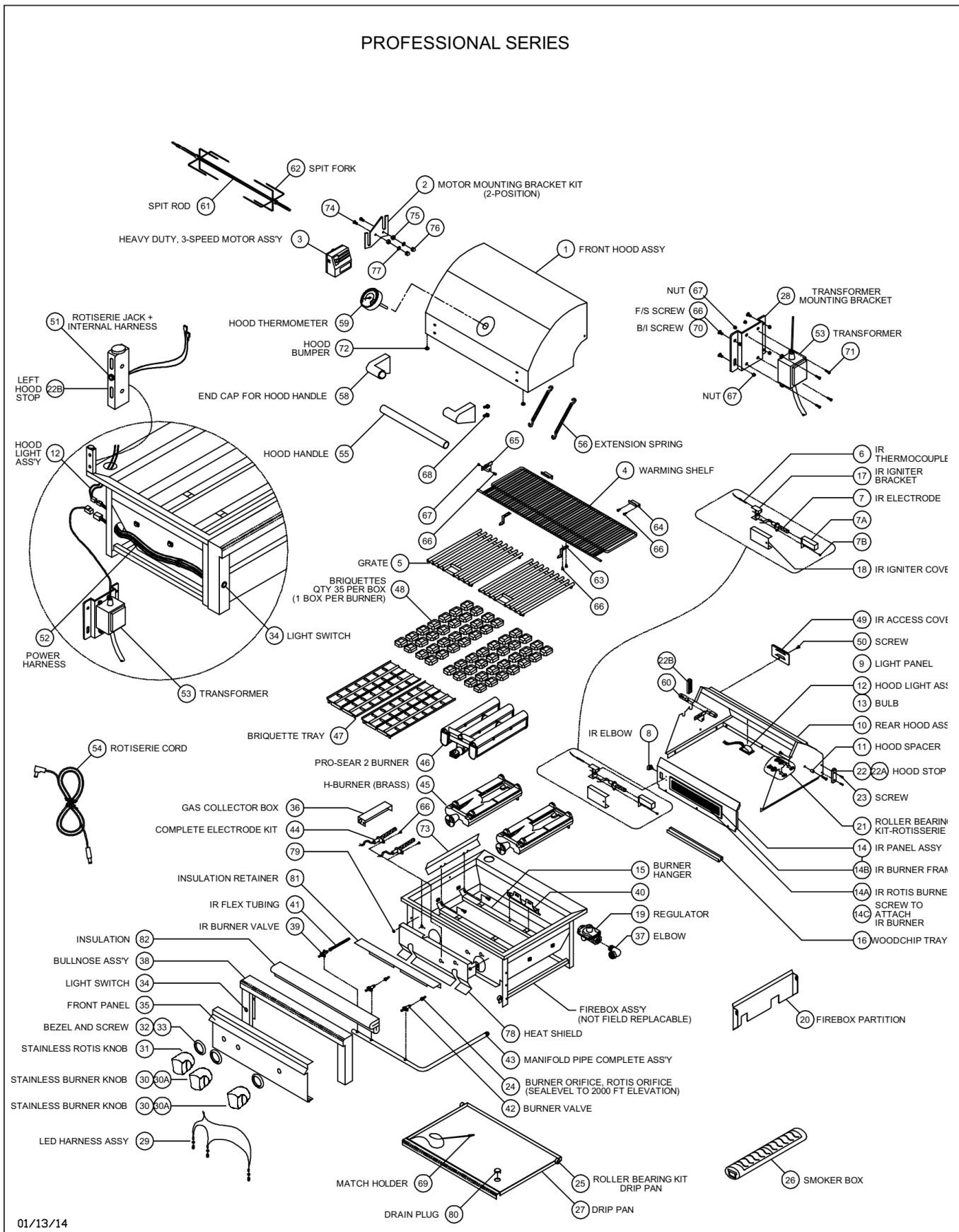

01/13/14

# PROFESSIONAL GRILLS PARTS LIST

## PROFESSIONAL SERIES PARTS LIST

ITEM	GRI SIZE	PART NO.	DESCRIPTION	ITEM	GRI SIZE	PART NO.	DESCRIPTION
	30	80309	FRONT HOOD ASSY, 30"	38	30	80516	BULLNOSE ASSY, PRO 30"
	36	80310	FRONT HOOD ASSY, 36"		36	80515	BULLNOSE ASSY, PRO 36"
	42	80311	FRONT HOOD ASSY, 42"		42	80517	BULLNOSE ASSY, PRO 42"
	54	80312	FRONT HOOD ASSY, 54"		54	80518	BULLNOSE ASSY, PRO 54"
2	ALL	90132	MOTOR MOUNTING BRACKET KIT, ALL PRO	39	ALL	31772	IR BURNER VALVE W/ MICROSWITCH
3	ALL	81071	MOTOR ASSY, HEAVY DUTY 3 SPEED	40	30,42,54 P/S	33405	BURNER SUPPORT, PROSEAR-2 30,42,54
4	30	32109	WARMING SHELF, PRO 30"		36 P/S	33809	BURNER SUPPORT, PROSEAR-2 36
	36	32110	WARMING SHELF, PRO 36"	41	ALL	31794	FLEX HOSE, 9 MM X 38" W/ 7/16 FITTINGS
	42	32111	WARMING SHELF, PRO 42"	42	ALL	33339	MAIN BURNER VALVE W/ MICROSWITCH
	54	32112	WARMING SHELF, PRO 54"		ALL	32845	MICROSWITCH REPLACEMENT FOR VALVE
5	30	30018	(2) GRATES- 13 1/2" X 21"	43	30	80212	MANIFOLD ASSY W/VALVES, 30" LP
	36	17020	(2) GRATES- 16 1/2" X 18 1/2"		30	80598	MANIFOLD ASSY W/VALVES, 30" LP NON-IR
	42	30018	(2) GRATES- 13 1/2" X 21"		30	80214	MANIFOLD ASSY W/VALVES, 30" NG
	42	30019	(1) GRATE-12" X 21" (CENTER)		30	80597	MANIFOLD ASSY W/VALVES, 30" NG NON IR
	54	30018	(2) GRATES- 13 1/2" X 21"		30	80211	MANIFOLD ASSY W/VALVES, 30" LP PROSEAR
	54	30019	(2) GRATES- 12" X 21"		30	80213	MANIFOLD ASSY W/VALVES, 30" NG PROSEAR
6	ALL	20018	IR THERMOCOUPLE		36	80227	MANIFOLD ASSY W/VALVES, 36" LP PROSEAR
7	ALL	33052	IR ELECTRODE, HOT SURFACE (SEE ALSO #73)		36	80228	MANIFOLD ASSY W/VALVES, 36" LP
7A	ALL	33093	GAS COLLECTOR BOX, IR ROTIS.		36	80229	MANIFOLD ASSY W/VALVES, 36" NG PROSEAR
	54	33102	GAS COLLECTOR BOX, IR ROTIS, R/H 54"		36	80230	MANIFOLD ASSY W/VALVES, 36" NG
7B	ALL	14018	SCREW, #6-32 X 1/4 PH. PAN HD		42	80201	MANIFOLD ASSY W/VALVES, 42" LP PROSEAR
8	ALL	31795	IR BRASS ELBOW, 7/16-20 MALE THREAD		42	80202	MANIFOLD ASSY W/VALVES, 42" LP
9	30	32156	LIGHT PANEL/REAR HOOD LINDER, 30"		42	80203	MANIFOLD ASSY W/VALVES, 42" NG PROSEAR
	36	32441	LIGHT PANEL FOR DUAL LIGHTS, 36"		42	80204	MANIFOLD ASSY W/VALVES, 42" NG
	42	32442	LIGHT PANEL FOR DUAL LIGHTS, 42"		54	80220	MANIFOLD ASSY W/VALVES, 54" LP PROSEAR
	54	32159	LIGHT PANEL FOR DUAL LIGHTS, 54"		54	80221	MANIFOLD ASSY W/VALVES, 54" NG PROSEAR
10	30	80269	REAR HOOD ASSY, PRO 30"	44	30 NON-IR	90184	COMPLETE ELECTRODE KIT, 30" NON-IR
	36	80270	REAR HOOD ASSY, PRO 36"		30	90185	COMPLETE ELECTRODE KIT, 30" IR
	42	80271	REAR HOOD ASSY, PRO 42"		36 NON-IR	90186	COMPLETE ELECTRODE KIT, 36" NON-IR
	54	80272	REAR HOOD ASSY, PRO 54"		36,42	90187	COMPLETE ELECTRODE KIT, 36"/42"
11	ALL	20054	HOOD SPACER, ALL PRO SERIES		54	90188	COMPLETE ELECTRODE KIT 54"
12	30	80446	HOOD LIGHT ASSY, SINGLE W/10W BULB	45	30,42,54	30485	H-BURNER (BRASS)
	36,42,54	80447	HOOD LIGHT ASSY, DUAL W/10W BULB		36	11012	H-BURNER (BRASS)
13	ALL	31979	BULB, REPLACEMENT, 10W HALOGEN	46	PS MODES	33415	PROSEAR-2 BURNER, 30", 42", 54"
	ALL	32322	GLASS REPLACEMENT COVER W/ CLIP		30,42,54	90181	SCREEN REPLACEMENT, PROSEAR 2 BURNER
14	30	80273	IR PANEL ASSY, 30" (INCLUDES BURNER)		PS MODES	33478	PROSEAR-2 BURNER, SHORT, 36"
	30 NON-IR	80599	REAR FINISHING PANEL, NON-IR, PRO 30"		36	90179	SCREEN REPLACEMENT, PROSEAR 2 BURNER, 36
	36	80274	IR PANEL ASSY, 36" (INCLUDES BURNER)	47	30,42,54	80645	BRIQUETTE TRAY, WIDE, 30", 42", 54"
	36 NON-IR	80601	REAR FINISHING PANEL, NON-IR, PRO 36"		30,42,54	90191	COMPLETE TRAY W/ BRIQUETTES & CLIPS
	42	80275	IR PANEL ASSY, 42" (INCLUDES BURNER)		42,54	80644	BRIQUETTE TRAY, NARROW, 42", 54"
	54	80276	IR PANEL ASSY, 54" (INCLUDES BURNER)		42,54	90190	COMPLETE TRAY W/ BRIQUETTES & CLIPS
14A	30,36,54	32989	IR ROTIS. BURNER ONLY (MEDIUM-21 IN.)		36	80643	BRIQUETTE TRAY, 36"
	42	32990	IR ROTIS. BURNER ONLY (LARGE-28 IN.)		36	90189	COMPLETE TRAY W/ BRIQUETTES & CLIPS
14B	30,36,54	32992	IR BURNER FRAME ONLY (MEDIUM-21 IN.)	48	ALL	90053	BRIQUETTES, 35 PER BOX
	42	32993	IR BURNER FRAME ONLY (LARGE-28 IN.)	49	ALL	30417	IR ACCESS COVER
14C	ALL	32644	SCREW, #8-32 X 5/16 PH. FLAT HD	50	ALL	14012	SCREW, 1/4-20 X 3/8 PH TRUSS HD, S/S
15	30	32484	BURNER HANGER, PRO 30"	51	ALL	80440	ROTISERIE JACK + INTERNAL HARNESS
	36	32245	BURNER HANGER, PRO 36"		ALL	33129	JACK ONLY, DC PANEL MOUNT
	42	32485	BURNER HANGER, PRO 42"	52	ALL	80533	MAIN POWER HARNESS (30, 36, 42, 54)
	54	32486	BURNER HANGER, PRO 54"		30 NON-IR	80534	MAIN POWER HARNESS, 30" NON-IR
16	30,54	10159	WOODCHIP TRAY (30", 54")	53	ALL	33100	TRANSFORMER, 5 AMP, ALL PRO
	36,42	10158	WOODCHIP TRAY (36", 42")	54	ALL	33416	ROTISERIE EXTERNAL CORD
17	ALL	33059	IR IGNITER BRACKET, PRO	55	30	35978	HOOD HANDLE, 30"
	54	33060	IR IGNITER BRACKET, RIGHT, 54"		36	35979	HOOD HANDLE, 36"
18	30	33135	IR IGNITER COVER, PRO 30"		42	35980	HOOD HANDLE, 42"
	36,42,54	33136	IR IGNITER COVER (36", 42", 54")		54	35981	HOOD HANDLE, 54"
19	ALL NG	30781	REGULATOR 4/11 N/G ONLY	56	30,42,54	31874	EXTENSION SPRING, 30", 42", 54"
	ALL LP	13053	REGULATOR W/30" HOSE DOUBLE STAGE-LP		36	31780	EXTENSION SPRING, 36"
20	30,42,54	33662	FIREBOX PARTITION, PROSEAR 30",42",54"	58	ALL	35984	END CAP FOR HOOD HANDLE
	36	33663	FIREBOX PARTITION, PROSEAR 36"	59	ALL	33558	HOOD THERMOMETER, SEALED
21	ALL	90128	ROLLER BEARING KIT-ROTISERIE (2 PARTS EA)		ALL	33573	WASHER FOR HOOD THERMOMETER
22	ALL	32468	HOOD STOP, RIGHT, ALL PRO	60	ALL	14013	PIVOT SCREW, 1/4-20 X 1" HEX DRIVE
22A	ALL	32470	BUMPER FOR HOOD STOP, 750 DIA		ALL	14009	PIVOT SCREW NUT, HEX, 1/4-20 S/S
22B	ALL	33389	HOOD STOP, LEFT, ALL PRO		ALL	14026	PIVOT WASHER, SPLIT LOCK, 1/4 S/S
23	ALL	32469	SCREW/HOOD STOP-#8-32 X 1" PH TRUSS HD	61	30	32128	SPIT ROD, PRO 30"
24	36	PRENGK	COMPLETE ORIFICE FIELD KIT-LP TO NG		36	32129	SPIT ROD, PRO 36"
	36	PRELPK	COMPLETE ORIFICE FIELD KIT-NG TO LP		42	32130	SPIT ROD, PRO 42"
	30,42,54	PRONGK	COMPLETE ORIFICE FIELD KIT-LP TO NG		54	32131	SPIT ROD, PRO 54"
	30,42,54	PROLPK	COMPLETE ORIFICE FIELD KIT-NG TO LP	62	ALL	31563	SPIT FORK, HEAVY DUTY, ALL SIZES
	36	13013	ORIFICE, BURNER, NG (#41 SHORT)	63	ALL	33033	FRONT RETAINING BKT., WARMING RACK
	36	13019	ORIFICE, BURNER, LP (#53 SHORT)	64	ALL	32133	REAR RETAINING BRACKET, WARMING RACK
	30,42,54	30329	ORIFICE, BURNER, NG (#41 LONG)	65	ALL	33597	LEFT RETAINING BRACKET, WARMING RACK
	30,42,54	30328	ORIFICE, BURNER, LP (#53 LONG)	66	ALL	14014	SCREW #8-32 X 3/8 PH TRUSS HEAD S/S
	PROSEAR	13015	ORIFICE, BURNER, NG (#44 SHORT)	67	ALL	14024	LOCK NUT, #8-32, S/S
	PROSEAR	13020	ORIFICE, BURNER, LP (#54 SHORT)	68	ALL	31930	BOLT, HEX HEAD, 1/4-20 X 3/8", S/S
	30,36,54	13016	ORIFICE, IR ROTIS., NG (#50 SHORT)	69	ALL	31031	ALTERNATE LIGHTING DEVICE, MATCH HOLDER
	30,36,54	13021	ORIFICE, IR ROTIS., LP (#57 SHORT)	70	ALL	31013	SCREW, #8 X 1/2 PH TRUSS HD TYPE 'A'
	42"	30470	ORIFICE, IR ROTIS., NG (#48 SHORT)	71	ALL	31649	SCREW, #8-32 X 5/8 PH. PAN HD, S/S
	42"	31342	ORIFICE, IR ROTIS., LP (#56 SHORT)	72	ALL	32477	HOOD BUMPER, 500 DIA
25	ALL	90129	ROLLER BEARING KIT-DRIP PAN (2 PARTS EA)	73	30,42,54	33609	BRIQUETTE DIVIDER 30",42",54"
26	30,36,42,54	34586	SMOKER SET		36	33751	BRIQUETTE DIVIDER, 36"
	30 36	18050 31494	DRIP PAN, PRO 36" DRIP PAN, PRO 30"	74	ALL	14099	SCREW, #10-24 X 3/4 PH FLAT HD S/S
	42	18051	DRIP PAN, PRO 42"	75	ALL	32939	ROTIS. SPACER
	54	31324	DRIP PAN, PRO 54"	76	ALL	32196	NUT, ACORN, #10-24, S/S
28	ALL	33130	TRANSFORMER MOUNTING BRKT B/I & F/S	77	ALL	32197	WASHER, #10 SPLIT LOCK, S/S
29	30 NON-IR	80434	LED HARNESS ASSY, 30" NON-IR	78	30	33659	HEAT SHIELD, PRO 30"
	30	80435	LED HARNESS ASSY, 30 IR		30	33654	HEAT SHIELD, PROSEAR 30"
	30 NON-IR	80614	LED HARNESS ASSY, 30" NON-IR		36	33658	HEAT SHIELD, PRO 36"
	36,42	80436	LED HARNESS ASSY, 36"/42"		36	33653	HEAT SHIELD, PROSEAR 36"
	36 NON-IR	80615	LED HARNESS ASSY, 36" NON-IR		42	33660	HEAT SHIELD, PRO 42"
	54	80437	LED HARNESS ASSY, 54"		42	33655	HEAT SHIELD, PROSEAR 42"
	ALL	32554	LED HOLDER		54	33656	HEAT SHIELD, PROSEAR 54"
30	ALL	36002	KNOB, BURNER, STAINLESS	79	ALL	14023	NUT, COMBINATION (FOR HEAT SHIELD)
30A	ALL	36004	KNOB, PROSEAR, STAINLESS	80	ALL	32839	DRAIN PLUG, DRIP PAN
31	ALL	36003	KNOB, ROTIS, STAINLESS	81	30	34676	RETAINER, INSULATION
32	ALL	36001	BEZEL		36	34630	RETAINER, INSULATION
33	ALL	34035	BEZEL SCREW, #6-32 X 1/8 PH PAN		42	34629	RETAINER, INSULATION
34	ALL	33148	LIGHT SWITCH + HARNESS, BLUE LIGHTED		54	34675	RETAINER, INSULATION
35	30	80539	FRONT PANEL, 30"	82	30	L20021	INSULATION 2 PCS (30" X 6")
	30 NON-IR	80596	FRONT PANEL, NON-IR, PRO 30"		36	L20021	INSULATION 2 PCS (36" X 6")
	36	80538	FRONT PANEL, PRO 36"		42	L20021	INSULATION 2 PCS (42" X 6")
	36 NON-IR	80602	FRONT PANEL, NON-IR, PRO 36"		54	L20021	INSULATION 2 PCS (54" X 6")
	42	80540	FRONT PANEL, PRO 42"				
	54	80541	FRONT PANEL, PRO 54"				
36	ALL	33058	GAS COLLECTOR BOX, H-BURNER				
37	ALL NG	13010	ELBOW, STREET, 1/2" 90 DEGREE-NG ONLY				
	ALL LP	13054	ELBOW, 3/8" FLARE TO 1/2" RIP-LP ONLY				



## MODEL-SPECIFIC BTU OUTPUTS & MAX. RUNS FOR APPLIANCES

MODEL-SPECIFIC BTU OUTPUTS				
MODEL	H BURNER (Btu)	ROTISSERIE (Btu)	PROSEAR™ 2 (Btu)	TOTAL INPUT
(C)VQGI5300/VQGFS5300(N/L)SS	1 @ 25,000	1 @ 14,000	1 @ 21,000	62,000 Btu/Hr
(C)VQGI5360/ VQGFS5360 (N/L)SS	2 @ 25,000	1 @ 14,000	1 @ 21,000	87,000 Btu/Hr
(C)VQGI5420/ VQGFS5420 (N/L)SS	2 @ 25,000	1 @ 16,000	1 @ 21,000	89,000 Btu/Hr
(C)VQGI5540/ VQGFS5540 (N/L)SS	3 @ 25,000	2 @ 14,000	1 @ 21,000	126,000 Btu/Hr

MAXIMUM RUNS FOR ALL APPLIANCES ON SUPPLY LINE	
Run Length 3/4" Pipe (in feet)	Max BTU for all Appliances on line
10	360,000
20	245,000
30	198,000
40	169,000
50	150,000
60	135,000
70	123,000
80	115,000

# INDEX

<b>A</b>		
Air Shutter Adjustment .....	17	
<b>B</b>		
Before Each Use .....	18	
Before You Start .....	7	
BTU Outputs, Model Specific .....	42	
Burner Adjustment, Low .....	16	
Burner Adjustment, Main .....	16	
Burner Appearance .....	17	
Burner Placement .....	29	
<b>C</b>		
Checklist Before Each Use.....	18	
Clean the Brass Burner.....	29	
Cleaning Your Grill.....	28	
Clearance to Combustibles .....	8	
Contacting Service .....	34	
Cut-out Dim., Built-in Grills .....	9	
<b>D</b>		
Damage:		
Concealed .....	7	
Visible .....	7	
Direct Heat Cooking .....	24	
Drip Tray .....	28	
<b>E</b>		
Electrical Connections .....	15	
Exploded Parts View .....	40	
<b>F</b>		
Final Checks .....	16	
Flame, Correct Size .....	17	
<b>G</b>		
Gas Connections .....	12	
Gas Line Purging .....	14	
Gas Requirements .....	12	
Gas Supply Line Runs .....	12	
Grilling in Windy Conditions .....	20	
<b>I</b>		
Important Safety Precautions .....	19	
Indirect Heat Cooking .....	24	
<b>L</b>		
Leak Test Procedure .....	16	
Lighting, Manual .....	23	
Lighting Your Grill .....	6, 22	
Lighting Rotisserie Burner .....	6, 22	
Low Heat Burner Adjustment .....	16	
LP Cylinder Requirements .....	13	
LP Gas .....	13	
<b>M</b>		
Manual Lighting.....	23	
Match Lighting .....	23	
Maximum Runs for all appliances on supply line.....	42	
<b>O</b>		
Obtaining Service.....	34	
<b>P</b>		
Parts List .....	41	
Parts View, Exploded .....	40	
Pre-Heating ProSear™ 2 Burner.....	25	
Pre-Heating the Grill .....	24	
Purging the Gas Line .....	14	
<b>R</b>		
Regulator Conversion .....	13	
<b>S</b>		
Schematic, L30.....	37	
Schematic, L36 & L42.....	38	
Schematic, L54 .....	39	
Service, Contacting .....	34	
<b>T</b>		
Technical Support .....	34	
Troubleshooting .....	30	
<b>U</b>		
Unpacking & Assembly.....	10	
Using Your Grill .....	21	
<b>W</b>		
Warranty:		
Warranty, Limited.....	35	
Warranty, Common Area Limited .....	36	
Windy Conditions, Grilling in .....	20	
Wiring Diagrams.....	37-39	



Viking Range, LLC  
111 Front Street  
Greenwood, Mississippi 38930  
(662)-455-1200  
Service: (888) 845-4641  
[www.vikingrange.com](http://www.vikingrange.com) in the US  
[www.brigade.ca](http://www.brigade.ca) in Canada