

ZENMUSE X5S

User Manual V1.2

2017.04

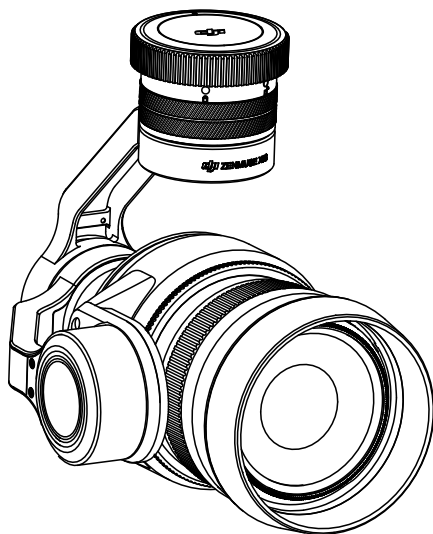

Searching for Keywords

Search for keywords such as “battery” and “install” to find a topic. If you are using Adobe Acrobat Reader to read this document, press Ctrl+F on Windows or Command+F on Mac to begin a search.

Navigating to a Topic

View a complete list of topics in the table of contents. Click on a topic to navigate to that section.

Printing this Document

This document supports high resolution printing.

Read Before the First Flight

Legends

 Warning

 Important

 Hints and Tips

 Reference

Using this manual

Read the following documents before using the ZENMUSE™ X5S

1. Zenmuse X5S Quick Start Guide
2. Zenmuse X5S User Manual

We recommend reading the Zenmuse X5S Quick Start Guide, especially its Disclaimer and Safety sections, to get familiar with all parts of the Zenmuse X5S. Refer to this Zenmuse User Manual for detailed information.

Getting more information

Visit the following webpage for more information about the Zenmuse X5S.

<http://www.dji.com/zenmuse-x5s/info#video>



Contents

Read Before the First Flight	2
Legends	2
Using this manual	2
Getting more information	2
Product Profile	4
Introduction	4
In the Box	4
Overview	5
Getting Started	5
Read the information below before setting up your Zenmuse X5S	5
Supported Devices	5
Supported Lenses for the DJI Inspire 2	5
Required Lens Accessories	6
Installing the Camera Lens	7
Mounting the Zenmuse X5S to the aircraft	8
Mounting the Zenmuse X5S to the Inspire 2	8
Mechanical Range	9
Using the Remote Controller	9
DJI GO 4 App	10
Downloading	10
Launching DJI GO 4 app	10
Camera Operation	10
Touch Interface	10
Basic Shooting	11
Taking Photos	11
Recording	11
Advanced Settings	11
Exposure Mode	11
Photo Styles	12
White Balance	12
List of Settings	13
Managing your Photos and Videos	14
Playback	14
Update Firmware	15
Appendix	16
Specifications	16

Product Profile

Introduction

Featuring M4/3 CMOS sensor, the Zenmuse X5S supports up to 20.80 MP still photo capture. It is capable of capturing 5.2K 30fps CinemaDNG video and Apple ProRes Video as well as 4K 60fps using H.264. The Zenmuse X5S is built using the M4/3 interchangeable lens standard. A variety of shooting modes, including single shooting, burst shooting and interval shooting, provide more options of capture. Burst and AEB is available, with up to 14 stills.

When the DJI™ CINESSD™ is in use, the Zenmuse X5S is able to record lossless videos with a bitrate of 5.2 Gbps in the CinemaDNG format or capture DNG stills at 20fps continuously.

The optional DJI kit lens is 15mm f/1.7 ASPH (equivalent to 30mm in 35mm format) with a 72-degrees field of view. Supported Lens details refer to Page 5 of Supported Lenses for the Inspire 2.

When mounted on the Inspire 2, the 3-axis gimbal provides a stable platform for the camera to get clear shots even during rapid maneuvering. The gimbal tilts the camera across a -130° to +40° pitch angle and pans ± 320° in both directions. Live HD video from the camera is streamed to the DJI GO™ 4 app.

In the Box

Check that all of the following items are in your package. If any item is missing, please contact DJI or your local dealer.

Zenmuse X5S ×1

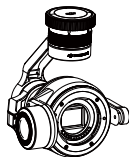

DJI MFT 15mm f/1.7 ASPH
Lens* ×1



Lens Hood* ×1



Camera Balancing
Ring* ×1 (BR-Φ46-10)



Camera Body Cap ×1



Lens Rear Cap* ×1



Carrying Case ×1

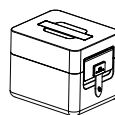

*The Zenmuse X5S lens kit includes an original lens (with lens cap), lens hood, camera body cap, lens rear cap and camera balancing ring, and the original lens (with lens cap), lens hood and camera balancing ring have been mounted on the Zenmuse X5S before delivery; Accessories for other supported lens can be purchased separately on the official DJI store.

Overview

Zenmuse X5S

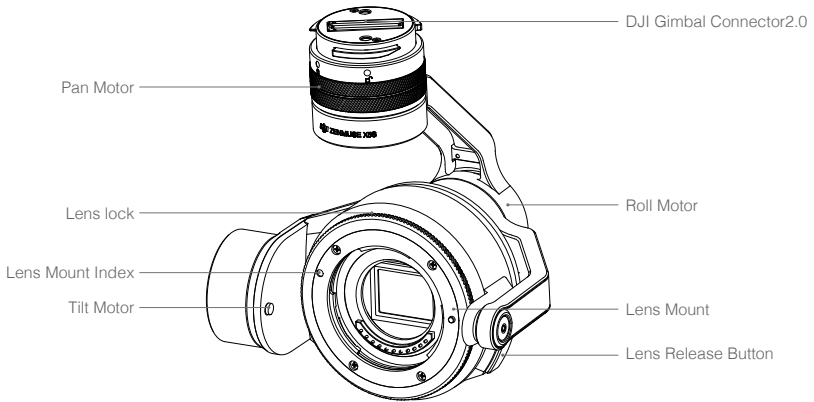

DJI MFT 15mm f/1.7 ASPH Lens

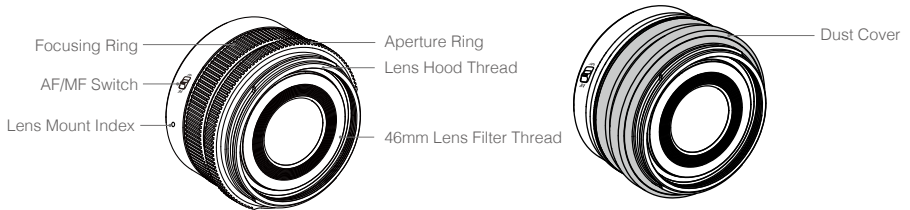

Getting Started

Read the information below before setting up your Zenmuse X5S

Supported Devices

The Zenmuse X5S can be attached to the following device, and will be compatible with other DJI devices in the future.

DJI Inspire 2

Supported Lenses for the DJI Inspire 2

The Zenmuse X5S currently supports the following lenses, and will support additional lenses in the future.

DJI MFT 15mm/1.7 ASPH

Panasonic Lumix 15mm/1.7
 Panasonic Lumix G X Vario PZ 14-42mm f/3.5-5.6 Power O.I.S
 Olympus M.Zuiko 12mm/2.0
 Olympus M.Zuiko 17mm/1.8
 Olympus M.Zuiko 25mm/1.8
 Olympus M.Zuiko 45mm/1.8
 Olympus M.Zuiko 9-18mm/4.0-5.6

-  • For sharp and clear video, the shutter speed should be no shorter than 1/500s when using a focal length of 15mm; and 1/600s when using a focal length of 25mm.

Required Lens Accessories

The performance of the gimbal is affected by the weight of the camera. The following table shows the recommended DJI Balancing Ring, Balancing Cap, filter and lens hood required for each lens model. Details are shown as below.

Lens	DJI Balancing Ring		Filter		Lens Hood
	A	B	Thread Size	Weight	
DJI MFT 15mm/1.7 ASPH	BR-Φ46-10	Not Required	46 mm	10 g	Required
Panasonic Lumix 15mm/1.7	BR-Φ46-10	Not Required	46 mm	10 g	Required
Panasonic Lumix G X Vario PZ 14-42mm f/3.5-5.6 Power O.I.S	BR-Φ37-17	BR-Φ37-6	37 mm	6 g	Not Required
Olympus M.Zuiko 12mm/2.0	BR-Φ46-10	Not Required	46 mm	10 g	Not Required
Olympus M.Zuiko 17mm/1.8	BR-Φ46-10	Not Required	46 mm	10 g	Not Required
Olympus M.Zuiko 25mm/1.8	BR-Φ46-10	Not Required	46 mm	10 g	Not Required
Olympus M.Zuiko 45mm/1.8	BR-Φ37-8	BR-Φ37-6	37 mm	6 g	Not Required

Lens	DJI Balancing Cap	DJI Balancing Ring B	Filter		Lens Hood
			Thread Size	Weight	
Olympus M.Zuiko 9-18mm/4.0-5.6	BC-Φ60-78	BR-Φ52-10	52 mm	10 g	Not Required

The thread size and weight of the Balancing Ring/ Balancing Cap are included in the model number, i.e.: BR-Φ46-10 has a thread size of 46 mm and a weight of 10 g.

-  • Choose the appropriate balancing ring/balancing cap based on the lens required.
- Ensure to attach the balancing ring (A)/balancing cap and the balancing ring(B) simultaneously, as illustrated when using the Panasonic Lumix G X Vario PZ 14-42mm f/3.5-5.6 Power O.I.S, Olympus M.Zuiko 45mm/1.8 and Olympus M.Zuiko 9-18mm/4.0-5.6. Attach the filter when the balancing ring (B) is not in use.
 - Two balancing rings, as illustrated, are required when using the Olympus M.Zuiko 17mm/1.8. When using a filter, remove a balancing ring.
 - The balancing cap should be attached to the rear of the lens when using the Olympus M.Zuiko 9-18mm/4.0-5.6. Detach the original rear cap of the lens before attaching the required balancing cap.
 - Digital zoom is not supported in the M. Zuiko Digital ED 9-18mm F4-5.6 lens.

Installing the Camera Lens

The following steps use the DJI MFT 15mm f/1.7-16 ASPH to demonstrate mounting a camera lens to the camera body. Be sure to power off the battery before installation.

1. Remove the camera body cap.
2. While holding down the Lens Release Button, rotate the Lens Lock clockwise to unlock it.
3. Remove the lens cap and rear cap.

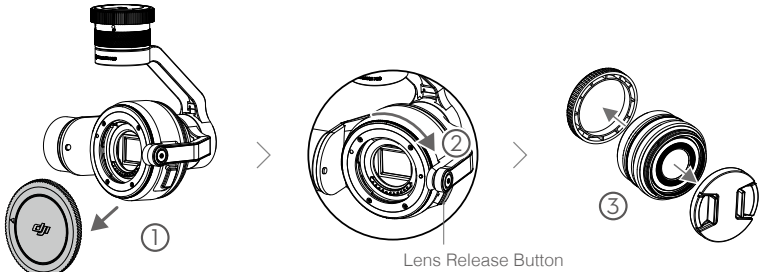

4. Align the two Lens Mount Indexes on the camera body and camera lens, and insert the camera lens into the body of the camera.
5. Rotate the camera lens clockwise until you hear a click.
6. Rotate the Lens Lock counterclockwise to lock it.
7. Mount the Balancing Ring (or a filter) and the Lens Hood.



To remove the camera lens, power off the battery.

1. While holding down the Lens Release Button, rotate the Lens Lock clockwise to unlock it.
2. While still holding down the Lens Release Button, rotate the camera lens counterclockwise to detach it.

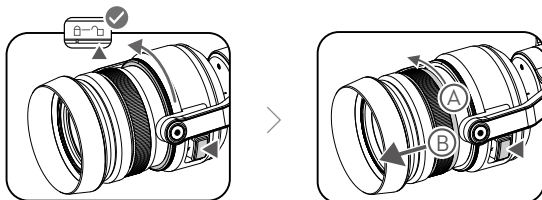

- ⚠ • Always power off the battery during installation or removal.
 - It is recommended to wrap a dust cover around the lens to prevent contamination. DJI produces dedicated dust covers for the DJI MFT 15mm f/1.7 ASPH and the Panasonic Lumix 15mm f/1.7 . Other lenses may require a third-party dust cover.
 - Always tighten the Lens Lock after attaching the camera lens, as this reduces lens vibration during flight. Always loosen the Lens Lock before attaching and detaching the camera lens.
 - Remember to use a filter that fulfils the weight requirements. For some lenses, use a filter and a balancing ring/balancing cap simultaneously if required.
 - Some lenses must not be used with a lens hood. Check the table above for accessory requirements for your lens.
 - Always hold down the lens release button before rotating the lens to detach it.
 - Always hold down the lens release button to unlock the lens lock.
 - Attach the camera body cap to the lens mount, and the lens cap and rear cap to the lens for protection after removal.
-

Mounting the Zenmuse X5S to the aircraft

Mounting the Zenmuse X5S to the Inspire 2

1. Remove the Gimbal Cap from the Zenmuse X5S.
2. Press the gimbal and the camera release button on the Inspire 2. Rotate to remove the Gimbal Cap from the Inspire 2.
3. Align the white dot on the gimbal to the red dot on Inspire 2 and insert the gimbal.
4. Rotate the Gimbal Lock to the locked position by aligning the red dots.

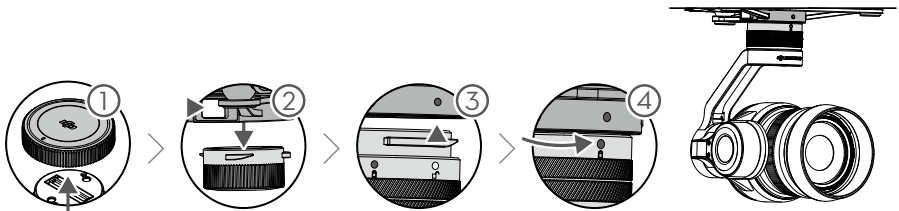

- ⚠ • Always ensure that the Gimbal Connector 2.0 on the Inspire 2 is in the right position when mounting, otherwise the camera will not mount.
 - Remove the lens cap when the Zenmuse X5S is in use.
 - DO NOT detach the Zenmuse X5S when the aircraft is powered on.
-

Mechanical Range

The 3-axis gimbal provides an incredibly stable and mobile platform for the camera system to capture completely smooth images and videos. The gimbal can tilt the camera up to 170 degrees, pan 320 degrees and roll 20 degrees in either direction.

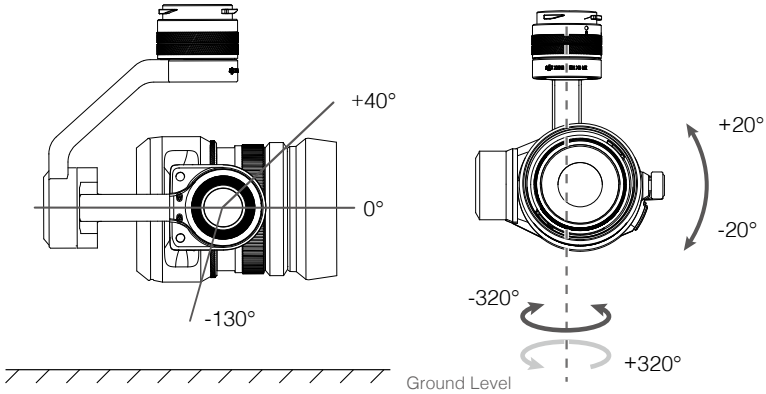

• Take off from flat, open ground and protect the gimbal at all times.

Using the Remote Controller

Press the Shutter Button to capture photos or the Record Button to record videos. Adjust the camera's tilt using the left dial. Turn the right dial to adjust camera settings.

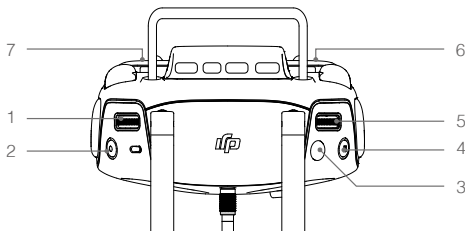

1. Left Dial

Scroll this dial to control tilt the gimbal. Scroll this dial while pressing the C1 to control yaw the gimbal; Scroll this dial while pressing C2 to control tilt the FPV camera.

2. Recording Button

Press once to start video recording. Press again to stop recording.

3. Shutter Button

Press to take a photo. If burst mode is selected, the set number of photos will be taken with one press.

4. Intelligent Flight Pause Button

Press once to exit from TapFly™, ActiveTrack™ and Advanced modes.

5. Right Dial

Press once and then scroll to set camera settings. Re-activate this function after 10s free of operation.

6. C2 Button

Set in DJI GO 4 app.

7. C1 Button

Set in DJI GO 4 app.

DJI GO 4 App

Downloading

Search for “DJI GO 4” in the App Store, or download at www.dji.com.

Launching DJI GO 4 app

1. Power on the remote controller and the aircraft.
2. Connect the remote controller and your mobile device via a USB cable.

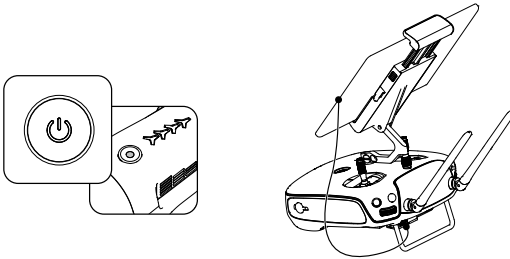

3. Launching DJI GO 4 app after successful connection, and the live HD video stream will begin.

Camera Operation

Touch Interface

The touch interface can be used for capturing photos, recording videos and playback. Professional photography configurations are also available.

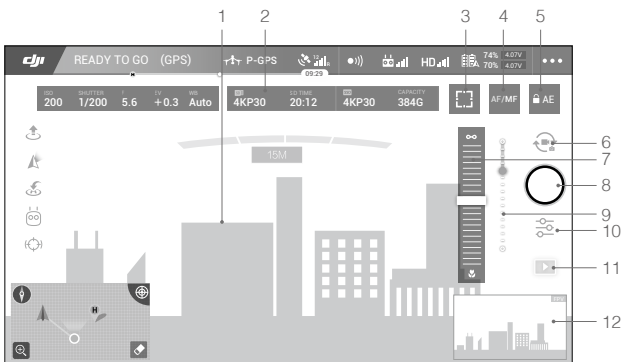



- | | | |
|--------------------------------|-------------------------------|---|
| 1. Live HD Video | 5. AE Lock | 10. Photography Configurations and Parameter Settings |
| 2. Current Camera Settings | 6. Shutter/Record Switch | 11. Playback |
| 3. Spot Metering/ Focus Switch | 7. MF Adjustment (in MF mode) | 12. FPV(Tablets only) |
| 4. AF/MF | 8. Shutter/Record | |
| | 9. Gimbal Slider | |

Basic Shooting

Insert supported Micro SD card into the Inspire 2 to activate still capturing and video recording. Insert a DJI CINESSD to activate continuous DNG burst shooting at 20fps, and lossless video recording in CinemaDNG and ProRes formats.

Taking Photos

Tap the Shutter/Record Switch  to select Shutter. Tap the button  to take photos.

Single shooting is set by default. Choose from one of the shooting modes via the DJI GO 4 app. Tap  ->  -> Video / Photo Setting -> Photo

Or tap the Current Camera Settings to quick set.

1. Multiple Mode

Take 3, 5, 7, 10, or 14 shots in a row.

2. AEB (Auto Exposure Bracketing)

Take 3 or 5 bracketed frames with ± 0.7 EV steps for exposure compensation.

3. Timed Shot



Take photos in 2, 3, 5, 7, 10, 15, 20, 30 or 60 second intervals.

4. RAW Burst Mode

Take 3, 5, 7, 10 or 14 shots in RAW format continuously. Also supports continuous burst shooting at 20fps.

Recording



You can start recording in the following two ways:

DJI GO 4 app: Tap Shutter/Record Switch button  to activate video recording mode, and then tap the button . Tap once to start recording video, then tap again to stop recording. The recording time length will be displayed below the Shutter/Record button.

Remote Controller: You can also press the Video Recording Button on the remote controller, which has the same function.

Advanced Settings

Exposure Mode

Tap  ->  to choose from the exposure modes, including: Auto, Aperture Priority(A), Shutter Priority(S), Manual Exposure(M). By setting different EV values, a variety of exposure can be

achieved in AUTO, S and A mode. ISO values can be set in all modes. When the aircraft is in P/S/A mode, you can choose to set the ISO automatically or manually.

1. Auto

Tap  -> AUTO. The shutter speed and aperture are set automatically to obtain the correct exposure.

2. Aperture Priority (A)

Tap  -> A. Set your required aperture, while the camera chooses the shutter speed automatically. This mode provides a wider depth of field and can be used to blur out backgrounds.

3. S (Shutter Priority)

Tap  -> S. Set your desired shutter speed, while the camera chooses the aperture automatically. This mode is ideal for freezing action, creating motion blur or low-light shots.

4. M (Manual Exposure)



Tap  -> M. Set aperture, shutter speed and ISO based on actual needs.

Photo Styles

Selecting different styles to capture photos with different sharpnesses, contrast levels and saturation. Tap  -> Video / Photo Settings -> Style.

1. **Standard:** A general-purpose style for most scenes.

2. **Landscape:** The camera will focus on as much of the scene as possible using a large depth of field.

3. **Soft:** Suitable for scenes with natural or soft colors.

4. **Custom:** Sharpness, contrast and saturation can be set separately.

Sharpness: The photos will be softer with lower values and clearer with higher values.

Contrast: Increasing the value will make images more dramatic.

Saturation: Colors will lighten at lower values and darken at higher values.

White Balance

White balance (WB) is the process of removing unrealistic color casts. Correcting white balance can help avoid the color casts, thereby improving photos under a wider range of lighting conditions. White balance can be either set into a fixed value or a dynamic value automatically.

Tap  -> Video / Photo Settings -> White Balance.

1. Auto(AWB)

The camera adjusts the white balance automatically.

2. Sunny / Cloudy / Incandescent / Neon

Choose one of these modes if natural-looking colors cannot be achieved through photo styles.

3. Custom

Set a value to compensate for a specific light source.

List of Settings

Photo	
Still Photography Modes	Micro SD: Single Shot, Multiple(3/5/7/10/14frames), AEB(3/5bracketed frames at 0.7EV bias), Timed Shot(2/3/5/7/10/15/20/30/60s) SSD: RAW Burst (3/5/7/10/14/ ∞frames)
Image Size	4:3,16:9
Image Format	SSD: DNG Micro SD: DNG, JPEG, DNG+JPEG
White Balance	Auto (AWB), Sunny, Cloudy, Incandescent, Neon, Custom (2000K~10000K)
Style	Standard, Landscape, Soft, Custom (Sharpness/Contrast/Saturation)
Video	Ordinary, TrueColor, D-Cinelike, D-Log, Film Looks
Video	
	H.264 C4K: 4096×2160 23.976/24/25/29.97/47.95/50/59.94p @100Mbps 4K: 3840×2160 23.976/24/25/29.97/47.95/50/59.94p @100Mbps 3840×1572 23.976/24/25/29.97p @100Mbps 2.7K: 2720×1530 23.976/24/25/29.97p @80Mbps 47.95/50/59.94p @100Mbps FHD: 1920×1080 23.976/24/25/29.97p @60Mbps 47.95/50/59.94p @80Mbps 119.88p @100Mbps
	H.265 C4K: 4096×2160 23.976/24/25/29.97p @100Mbps 4K: 3840×2160, 23.976/24/25/29.97p @100Mbps 3840×1572 23.976/24/25/29.97p @100Mbps 2.7K: 2720×1530 23.976/24/25/29.97p @65Mbps 47.95/50/59.94p @80Mbps FHD: 1920×1080 23.976/24/25/29.97p @50Mbps 47.95/50/59.94p @65Mbps 119.88p @100Mbps
Video Size	C-DNG RAW 5.2K: 5280×2972 23.976/24/25/29.97p, up to 4.2Gbps 4K: 4096×2160, 3840×2160 23.976/24/25/29.97p, up to 2.4Gbps 4K: 4096×2160, 3840×2160 50/59.94p, up to 4.0Gbps ProRes 5.2K: 5280×2160 23.976/24/25/29.97p, 422 HQ @1.3Gbps 4K: 3840×2160 23.976/24/25/29.97p, 422 HQ @900Mbps 4K: 3840×2160 23.976/24/25/29.97p, 4444 XQ @2.0Gbps
Video Format	Micro SD: MP4/MOV (H.264, H.265) SSD: CinemaDNG (JPEG Lossless) ProRes (422HQ、4444XQ)

NTSC/PAL PAL, NTSC

Specifications

Supported Micro SD Cards(Insert into the aircraft)	Sandisk Extreme 32GB UHS-3 MICROSDHC Sandisk Extreme 64GB UHS-3 MICROSDXC Panasonic 32GB UHS-3 MicroSDHC Panasonic 64GB UHS-3 MicroSDXC Samsung PRO 32GB UHS-3 MicroSDHC Samsung PRO 64GB UHS-3 MicroSDXC Samsung PRO 128GB UHS-3 MicroSDXC
Center Point	None, Circle, Cross, Narrow Cross, Square (No Center Point), Square(w. Center Point), Bracket (No Center Point), Bracket (w. Center Point)
Anti-Flicker	Auto, 50Hz, 60Hz
Grid	None, Grid Lines, Grid+Diagonals
File Index Mode	Reset, Continuous
Smart Arm LEDs	Off, Front LEDs Auto Turn Off, Turn Off Back LEDs, Turn Off Arm LEDs
Other	Histogram, Video Caption, AF Focus Assistant, Over Exposure Warning, MF Focus Assistant, Lens Profile, Calibration, Reset Camera Settings, Format SD Card, Format SSD Card

* Manual lens calibration is required when used for the first time. Incorrect calibration will result in an inability to focus to infinite. Calibrate camera in the camera setting page in the DJI GO 4 app.

Managing your Photos and Videos

Playback

DJI GO 4 App: Tap the playback button  in the DJI GO 4 app to review photos and videos that you have captured. Press the same button again to return to capture images.

 Photos and videos are saved in Micro SD card or SSD card.

Update Firmware

The firmware of the Zenmuse X5S should be updated together with the Inspire 2. Using an Inspire 2 with the Zenmuse X5S mounted as an example.

Method 1: Using the DJI ASSISTANT™ 2

1. Power on the Intelligent Flight Battery, and toggle the USB Mode Switch down.
2. Connect the Inspire 2 and the PC via the USB cable (with Double A ports).
3. Launch DJI Assistant 2 and login with a DJI account.
4. Click Inspire 2 and the firmware update button.
5. Select the firmware version required.
6. DJI Assistant 2 will download and upgrade the firmware automatically.
7. Restart the aircraft after the firmware upgrade is complete.

Method 2: Using the DJI GO 4 app

1. Power on the Intelligent Flight Battery, and toggle the USB Mode Switch up.
2. Connect the aircraft and your mobile device via an appropriate USB cable.
3. Follow the on-screen instructions in the DJI GO 4 app to upgrade. Ensure to connect to the Internet when downloading the firmware.
4. Restart the aircraft after the firmware update is complete.



- During update, the aircraft start a quick single beep continuously. Then the warning sound will alternate between a longer beep and a quick double beep once the update is complete. Restart the aircraft after the firmware update is complete.
 - If the warning sound turns into a long beep, retry the update.
 - The battery level should be above 30% for the firmware update process.
 - When using the DJI GO 4 app to update, you may disconnect the aircraft and the mobile device once the update is more than 30% completed. No Internet connection is required.
-

Appendix

Specifications

General

Name	ZENMUSE X5S
Dimensions	140 mm (W) × 98mm (H) ×132 mm (D)
Weight	Approx. 461 g(Including original lens, balancing ring, lens hood)
Operating Temperature Range	-4° to 104°F (-20° to 40°C)
Storage Temperature	-4° to 140°F (-20° to 60°C)

Camera

Lens	Replaceable lens M4/3mount supporting auto-focus
Supported Lenses (DJI Inspire 2)	DJI MFT 15mm/1.7 ASPH Panasonic Lumix 15mm/1.7 Panasonic Lumix G X Vario PZ 14-42mm f/3.5-5.6 Power O.I.S Olympus M.Zuiko 12mm/2.0 Olympus M.Zuiko 17mm/1.8 Olympus M.Zuiko 25mm/1.8 Olympus M.Zuiko 45mm/1.8 Olympus M.Zuiko 9-18mm/4.0-5.6
Sensors	4/3 CMOS
Effective Pixels	20.80 MP
Image Size	4:3, 16:9
ISO Range	Photo: 100-25600 Video: 100-6400
Electronic Shutter Speed	Photo: 8 s -1/8000 s Video: 1/24 s -1/8000 s
Field of View	DJI MFT 15mm F1.7 ASPH 72°
Still Photography Modes	Micro SD: Single Shot, Multiple(3/5/7/10/14frames), AEB(3/5bracketed frames at 0.7EV bias), Timed Shot(2/3/5/7/10/15/20/30/60s) SSD: RAW Burst (3/5/7/10/14/ ∞frames)

Video Recording Modes	<p>H.264</p> <p>C4K: 4096×2160 23.976/24/25/29.97/47.95/50/59.94p @100Mbps 4K: 3840×2160 23.976/24/25/29.97/47.95/50/59.94p @100Mbps 3840×1572 23.976/24/25/29.97p @100Mbps 2.7K: 2720×1530 23.976/24/25/29.97p @80Mbps 47.95/50/59.94p @100Mbps FHD: 1920×1080 23.976/24/25/29.97p @60Mbps 47.95/50/59.94p @80Mbps 119.88p @100Mbps</p> <p>H.265</p> <p>C4K: 4096×2160 23.976/24/25/29.97p @100Mbps 4K: 3840×2160, 23.976/24/25/29.97p @100Mbps 3840 × 1572 23.976/24/25/29.97p @100Mbps 2.7K: 2720×1530 23.976/24/25/29.97p @65Mbps 47.95/50/59.94p @80Mbps FHD: 1920×1080 23.976/24/25/29.97p @50Mbps 47.95/50/59.94p @65Mbps 119.88p @100Mbps</p> <p>C-DNG RAW</p> <p>5.2K: 5280×2972 23.976/24/25/29.97p, up to 4.2Gbps 4K: 4096×2160, 3840×2160 23.976/24/25/29.97p, up to 2.4Gbps 4K: 4096×2160, 3840×2160 50/59.94p, up to 4.0Gbps</p> <p>ProRes</p> <p>5.2K: 5280×2160 23.976/24/25/29.97p, 422 HQ @1.3Gbps 4K: 3840×2160 23.976/24/25/29.97p, 422 HQ @900Mbps 4K: 3840×2160 23.976/24/25/29.97p, 4444 XQ @2.0Gbps</p>
Video Storage Bitrate	<p>Micro SD: 100 Mbps SSD: 4.2 Gbps</p>
Image Format	DNG, JPEG, DNG+JEPG
Video Format	<p>Micro SD: MP4/MOV (H.264, H.265) SSD: CinemaDNG(JPEG Lossless) ProRes (422HQ, 4444XQ)</p>
Supported Micro SD Cards (Insert into the aircraft)	<p>Sandisk Extreme 32GB UHS-3 MICROSDHC Sandisk Extreme 64GB UHS-3 MICROSDXC Panasonic 32GB UHS-3 MicroSDHC Panasonic 64GB UHS-3 MicroSDXC Samsung PRO 32GB UHS-3 MicroSDHC Samsung PRO 64GB UHS-3 MicroSDXC Samsung PRO 128GB UHS-3 MicroSDXC</p>
Default Lens	
Name	DJI MFT 15mm F1.7 ASPH

Focal Length	f=15 mm (35 mm format equivalent 30mm)
Aperture Type	7 diaphragm blades/circular aperture diaphragm
Maximum Aperture	F1.7
Minimum Aperture	F16
Lens Construction	9 elements in7 groups (3 aspherical lenses)
Focus Distance	0.2 m to ∞ (from the focus distance reference line)
Mount	M4/3 Mount
Angle of View	72°
Max. Diameter	Approx. 57.5 mm
Overall Length	Approx. 36 mm
Weight	Approx. 115 g
Gimbal	
Angular Vibration Range	$\pm 0.01^\circ$
Mount	Detachable
Controllable Range	Pitch: -130°to +40°; Pan: $\pm 320^\circ$; Roll: $\pm 20^\circ$
Max Controllable Speed	Pitch: 180°/s; Pan:270°/s; Roll:180°/s

Zenmuse X5S does not support file storage. Please save your photos and videos in the Micro SD/SSD cards inserted in the aircraft.

DJI Support

<http://www.dji.com/support>

This content is subject to change.

Download the latest version from
<http://www.dji.com/zenmuse-x5s>



If you have any questions about this document, please contact DJI by sending a message to DocSupport@dji.com.

Copyright © 2017 DJI All Rights Reserved.