



*ASSEMBLY INSTRUCTIONS*  
*COASTER FINE FURNITURE*



*Fine Furniture for every stage of life*

**107931**  
**Dining Table**

## ASSEMBLY INSTRUCTIONS

### ASSEMBLY TIPS:

1. Remove hardware from box and sort by size.
2. Please check to see that all hardware and parts are present prior to start of assembly.
3. Please follow attached instructions in the same sequence as numbered to assure fast & easy assembly.



### WARNING!

1. Don't attempt to repair or modify parts that are broken or defective. Please contact the store immediately.
2. This product is for home use only and not intended for commercial establishments.



**ASSEMBLY TIME**

**10 MINUTES**

## PARTS IDENTIFICATION

### B1 ( BOX 1 )

**A GLASS TOP**

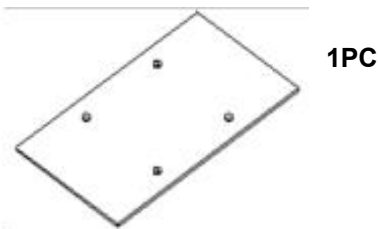

**1PC**

### B2 ( BOX 2 )

**B LEG**



**4PCS**

**C CONNECTION BOX**

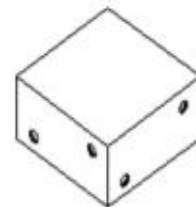

**1PC**

## HARDWARE IDENTIFICATION

**Z-B2 (BOX 2) - HARDWARE PACK IS LOCATED IN 107931 (B2)**

**1 ALLEN KEY  
(4MM)**



**1PC**

**2 SCREW  
(M6\*10)**



**4PCS**

**3 SCREW  
(M8\*10)**



**8PCS**

**4 ALLEN KEY  
(5MM)**

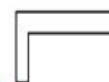

**1PC**

**5 ADJUSTING FOOT  
(Φ20\*7\*M6\*10)**



**4PCS**

### NOTE:

Phillips head screw driver is required in the assembly process; however, manufacturer does not provide this item.

ITEM: **107931**



## ASSEMBLY INSTRUCTIONS

### STEP 1

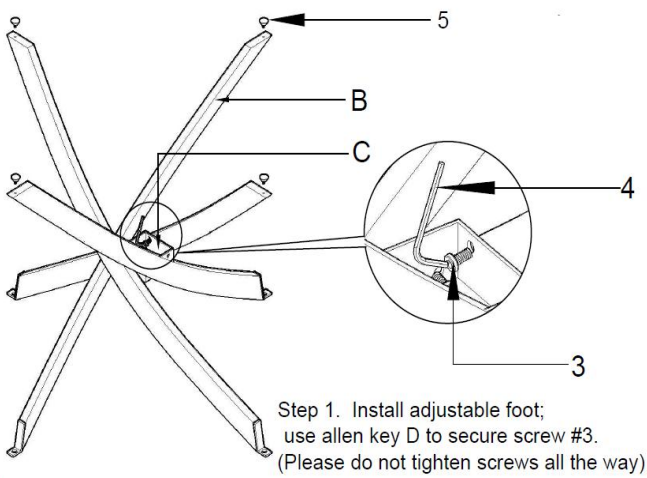

Step 1. Install adjustable foot;  
use allen key D to secure screw #3.  
(Please do not tighten screws all the way)

### STEP 2

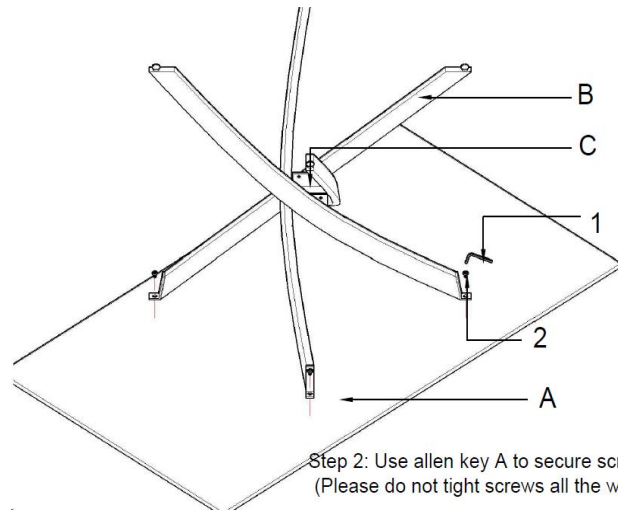

Step 2: Use allen key A to secure screw #2  
(Please do not tight screws all the way)

### STEP 3 **COMPLETE**

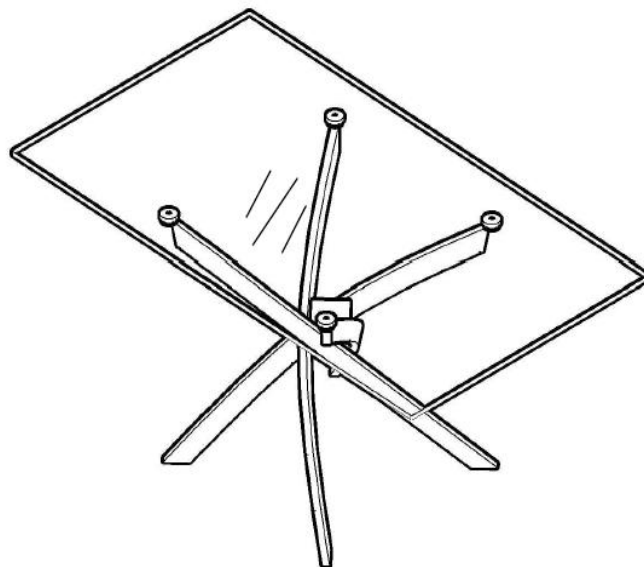

Step 3. Now tight screw 2&3 up after stationary.

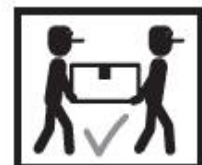

ITEM:107931

