

RS27T5561SR

SAMSUNG

26.7 cu. ft. Large Capacity Side-By-Side Refrigerator with 21.5" Touchscreen Family Hub™



6 Simple Truths

What should we have for dinner?

See inside your refrigerator from anywhere, shop for groceries, search for recipes and pre-heat your oven all from the Family Hub.

I love entertaining friends and family

Stream your favorite music apps on the Family Hub and enjoy premium speaker quality listening.

I miss out because I'm busy in the kitchen

Mirror shows, movies, or live sports from your Samsung TV on the Family Hub.

I'm always multi-tasking

Get a notification on the Family Hub when the laundry is done.

I want peace of mind when I am home with my family

See who's at the front door. Monitor the baby's room. Adjust the thermostat all from the Family hub.

It's the little moments that matter

Upload pictures remotely to the Family Hub. Leave handwritten notes for loved ones. Set reminders for when you get home.

Available Colors

 Fingerprint Resistant Stainless Steel (shown)

 Fingerprint Resistant Black Stainless Steel



Family Hub™



Large Capacity

Design

- Large Capacity of 26.7 cu. ft.
- Fingerprint Resistant Finish
- Minimal Display Dispenser: external filtered water and ice
- LED Lighting
- Four Gallon Door Bins
- Two Clear Drawers
- 25W Speaker

Convenience

- Wi-Fi and Bixby Enabled
- Adjustable Top Shelf
- Door Alarm
- Water Filter Indicator

Performance

- All-Around Cooling
- In-Door Ice Maker - Stores up to 4.4 lbs of ice

Rating



ENERGY STAR® rated:
691 kWh/yr

RS27T5561SR

SAMSUNG

26.7 cu. ft. Large Capacity Side-By-Side Refrigerator with 21.5" Touchscreen Family Hub™

Installation Specifications

1. Measure the height, width and depth of the opening, making sure to include baseboards, molding tile, countertop overhang, etc. Check to be sure there is enough room to open the door (consider walls, islands or other obstacles when measuring).
2. Refer to illustration below to determine dimensions.
3. Allow 2.5" of clearance on hinge side of refrigerator when installing next to a wall where handle may make contact.
4. Allow 1" minimum clearance at rear for proper air circulation and water/electrical connections. Allow a 3/8" minimum clearance at sides and top for ease of installation.
5. Ensure each door and entryway in the home is wide enough for the refrigerator to be moved through easily.

For optimal usage and to be able to open refrigerator doors completely, do not install next to a wall.

Please note: The following dimension and cutout information is for planning purposes only. For complete installation details, consult manual packed with product, or download manual online at samsung.com.

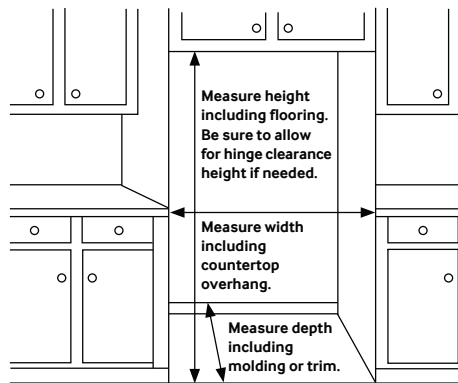

Dimensions

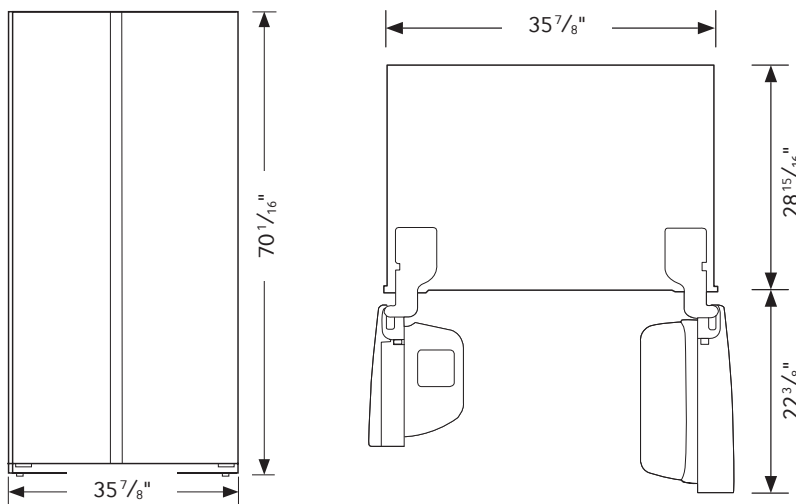

Total Capacity: 26.7 cu. ft.

Refrigerator: 17.2 cu. ft.

- 5 Tempered Glass Shelves
- 2 Clear Drawers
- 2 Drawers
- 5 Door Bins
 - 2 Gallon Bins
 - 3 Door Bins
- LED Lighting

Freezer: 9.5 cu. ft.

- External Filtered Water and Ice Dispenser (Crushed or Cubed Ice)
- In-Door Ice Maker
- 4 Tempered Glass Shelves
- 2 Drawers
- 2 Door Bins
- LED Lighting

Accessories

Water Filter: HAF-QIN

Warranty

One (1) Year Parts and Labor on Refrigerator

Five (5) Years Parts and Labor on

Sealed Refrigeration System Only*

Ten (10) Years Parts and Five (5) Years

Labor on Digital Inverter Compressor

*Compressor, evaporator, condenser, drier and connecting tubing.

Product Dimensions & Weight

Dimensions (WxHxD with hinges, handles, doors and dispenser): 35⁷/₈" x 70¹/₁₆" x 33¹/₂"

Dimensions (WxHxD without hinges and door):

35⁷/₈" x 68⁵/₈" x 28¹⁵/₁₆"

Dimensions (WxHxD with hinge and door, no handle):

35⁷/₈" x 70¹/₁₆" x 33¹/₂"

Weight: 306 lbs

Shipping Dimensions & Weight (WxHxD)

Dimensions: 37³/₄" x 75³/₈" x 35"

Weight: 315 lbs

Color	Model #	UPC Code
Fingerprint Resistant Stainless Steel	RS27T5561SR	887276372174
Fingerprint Resistant Black Stainless Steel	RS27T5561SG	887276372167