

ASSEMBLY INSTRUCTIONS
for Guard Rail
STERLING 3 IN 1 CONVERTIBLE CRIB
Model #13895

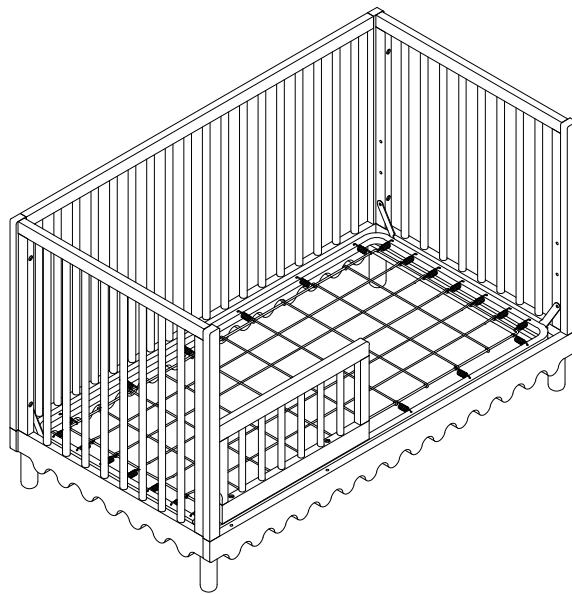

Thank you for your purchase!

Remove all parts and hardware from the box and lay on a carpeted or scratch -free work surface.

Do not dispose of any contents until assembly is completed.

Familiarize yourself with all exhibits and diagrams to facilitate the assembly of your crib.

TOOLS REQUIRED:

ALLEN KEY (Included)



PARTS ENCLOSED IN CARTON

A. Guardrail (1 pc)

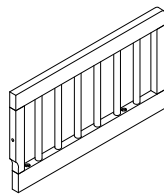

B. Stabilizer bar (1 pc)

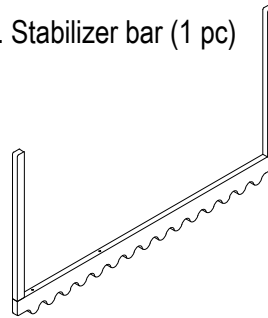

HARDWARE

(C) Allenbolt 2-3/4" (70 mm) (2 pcs)

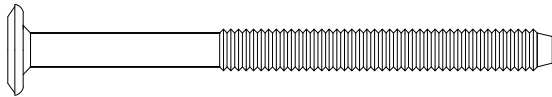

(D) Allenbolt 1-5/8" (40 mm) (1 pc)

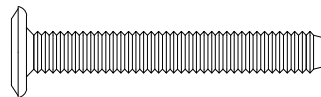

(E) Spring washer (3 pcs)



(H) Allen key (1 pc) (length may vary)



Do not fully tighten all bolts until all parts are in place.

(please add an extra 1/2 revolution to the bolts when using spring washer after tightening)

STEP 1 " UNINSTALL SIDE FRAME "

THIS STEP REQUIRES:

H. Allen key (1 pc)



STEP 1

FIG.1

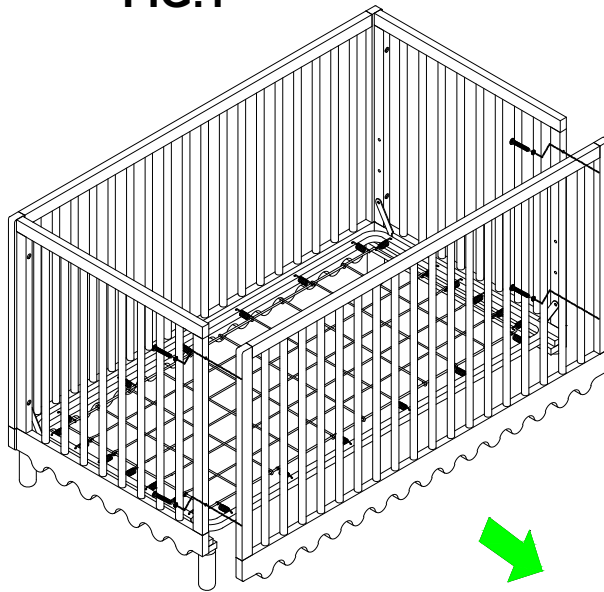

STEP 1:

- Remove 1pc Side frame as shown in FIG.1

STEP 2 " ASSEMBLY OF STABILIZER BAR "

THIS STEP REQUIRES:

B. Stabilizer bar (1 pc)

H. Allen key (1 pc)



STEP 2

FIG.2

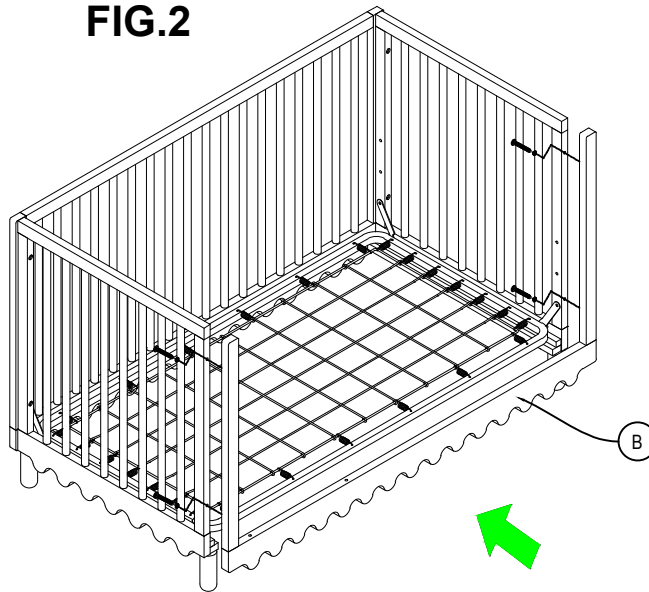

STEP 2:

- Attached Stabilizer bar (B) to End frame by using Allen bolt, Spring washer from previous step as shown in FIG.2.

STEP 3 " MATTRESS SUPPORT HEIGHT ADJUSTMENT"

THIS STEP REQUIRES :

H. Allen key (1 pc)



STEP 3

FIG.4

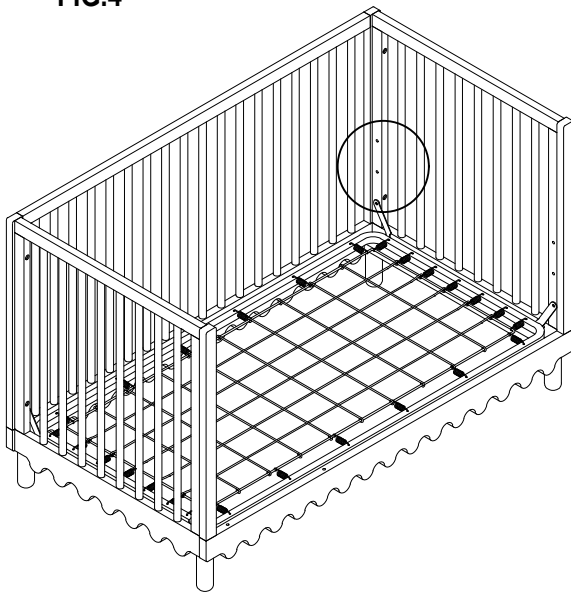
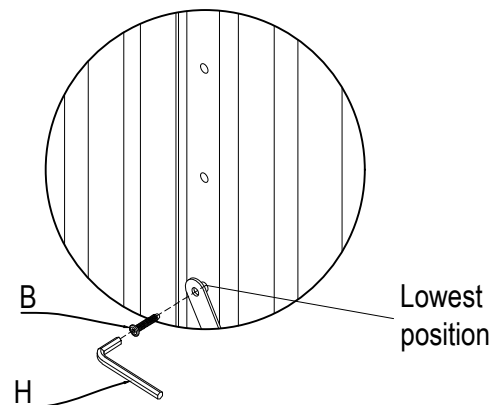

FIG.3



STEP 3:

- Remove the Allen bolt (B) on the Mattress spring.
- Move Mattress spring to the lowest position as shown in FIG.3.
- Attach the Allen bolt (K) on the lowest hole of End frame
- Final position as shown in FIG.4.

STEP 4 " ASSEMBLY OF GUARD RAIL "

THIS STEP REQUIRES :

A. Guard rail (1 pc)

H. Allen key (1 pc)

C. Allenbolt 2-3/4" (70 mm) (2 pcs)

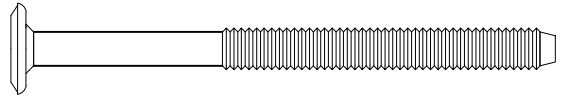

D. Allenbolt 1-5/8" (40 mm) (1 pc)

E. Spring washer (3 pcs)

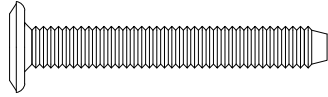

STEP 4

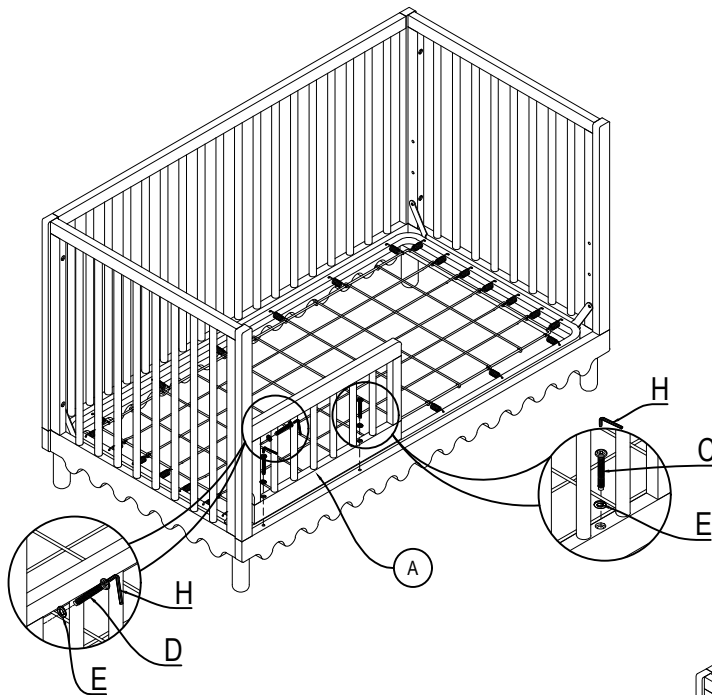
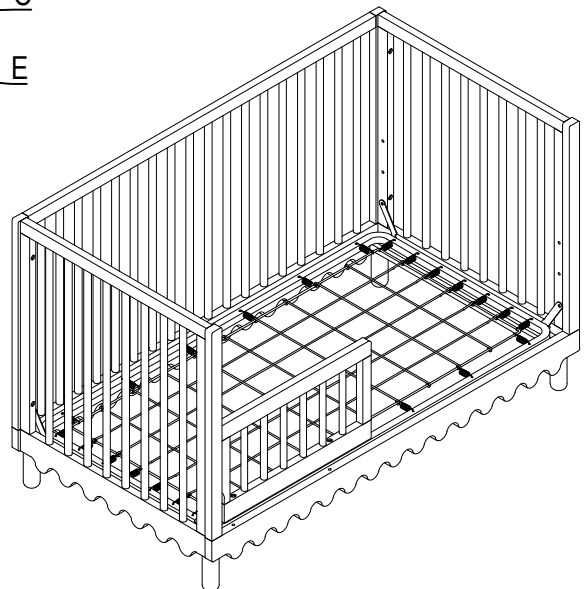

FIG.5

FIG.6

FIG.7



STEP 4:

- Insert the Allen bolt (C) and Spring Washer (E) through 2 holes in the stabilizer bar and bottom rail of Guardrail (A) as shown in FIG.5.
- Insert the Allen bolt (D) through the hole of middle position of stabilizer post and side rail of Guardrail (A) as shown in FIG.6.
- Tighten all bolts with Allen key (H). Assembly complete as shown in FIG.7. Thank You!

 **“CAUTION: ANY MATTRESS USED IN THIS CRIB MUST BE AT LEAST 27 1/4 INCHES (69 CM) BY 51 5/8 INCHES (131 CM) WITH A THICKNESS NOT EXCEEDING 6 INCHES (15 CM). THE DIMENSIONS OF THE MATTRESS SHALL BE TAKEN FROM SEAM TO SEAM OR EDGE TO EDGE WHERE APPROPRIATE.”**

 **WARNING!**

FOR TODDLER BED USE

- READ ALL INSTRUCTIONS BEFORE ASSEMBLING TODDLER BED.
KEEP INSTRUCTIONS FOR FUTURE USE.
- FAILURE TO FOLLOW THESE WARNINGS AND THE ASSEMBLY INSTRUCTIONS COULD RESULT IN SERIOUS INJURY OR DEATH FROM ENTRAPMENT OR STRANGULATION.
- **CAUTION:** THE MATTRESS INTENDED FOR USE ON THE BED SHALL BE A FULL-SIZE CRIB MATTRESS HAVING MINIMUM DIMENSION OF 51 5/8 INCHES (1310 MM) IN LENGTH AND 27 1/4 INCHES (690 MM) IN WIDTH AND NOT EXCEEDING 6 INCHES (150 MM) IN THICKNESS. THE DIMENSION OF THE MATTRESS SHALL BE TAKEN FROM SEAM TO SEAM OR EDGE TO EDGE WHERE APPROPRIATE.
- THE MINIMUM AGE OF THE INTENDED USER SHALL NOT BE LESS THAN 15 MONTHS AND THE MAXIMUM WEIGHT SHALL NOT BE GREATER THAN 50 LB (22.7 KG).
- **GUARDRAIL (SOLD SEPARATELY) MUST BE USED** WHEN CRIB USED AS A TODDLER BED TO AVOID THE FORMATION OF A GAP BETWEEN THE MATTRESS AND THE BED THAT COULD CAUSE AN ENTRAPMENT.
- **DO NOT** PLACE BED NEAR WINDOWS WHERE CORDS FROM BLINDS OR DRAPES MAY STRANGLE A CHILD.
- **DO NOT** PLACE ITEMS WITH A STRING, CORD, OR RIBBON AROUND A CHILD'S NECK, SUCH AS HOOD STRINGS OR PACIFIER CORDS.
- **DO NOT** SUSPEND STRINGS OVER A TODDLER BED FOR ANY REASON.
- WHEN STORING TODDLER BED USE CAUTION AS EXTREME CHANGE IN TEMPERATURE OR HUMIDITY CAN COMPROMISE THE TODDLER BED MAKING IT EXTREMELY DANGEROUS TO YOUR CHILD. STORE THE TODDLER BED IN A CLEAN DRY PLACE.
- USE CAUTION WHEN A VAPORIZER OR HUMIDIFIER IS IN USE. ALWAYS AIM VAPOR AWAY FROM THE TODDLER BED AS WELL AS ANY OTHER WOODEN FURNITURE. PROLONGED PERIODS OF HUMIDITY IN STORAGE AS WELL AS THE HOME CAN COMPROMISE THE TODDLER BED.
- AVOID USING VAPORIZERS AND HUMIDIFIER FOR PROLONGED PERIODS OF TIME.
- PLEASE DISPOSE ALL PACKAGING AND PLASTIC BAGS.
- PLEASE CLEAN THE TODDLER BED WITH A DRY CLOTH AND USE MILD WOOD POLISH IF REQUIRED.
- **PREVENT BURNS.** KEEP BED AWAY FROM OPEN FIRES AND OTHER HEAT SOURCES.
- CHECK THIS PRODUCT FOR DAMAGED HARDWARE, LOOSE JOINTS, LOOSE BOLTS OR OTHER FASTENERS, MISSING PARTS OR SHARP EDGES BEFORE AND AFTER ASSEMBLY AND FREQUENTLY DURING USE. SECURELY TIGHTEN LOOSE BOLTS AND OTHER FASTENERS. **DO NOT** USE CRIB IF ANY PARTS ARE MISSING, DAMAGED OR BROKEN. CONTACT M DESIGN VILLAGE , 701 COTTONTAIL LANE, SOMERSET, NJ 08873; PHONE: 1-844-247-5908; EMAIL: INFO@MDESIGNVILLAGE.COM FOR REPLACEMENT PARTS AND INSTRUCTIONAL LITERATURE IF NEEDED. **DO NOT** SUBSTITUTE PARTS.

WARNING ENTRAPMENT/STRANGULATION HAZARD

- INFANTS HAVE DIED IN TODDLER BEDS FROM ENTRAPMENT AND STRANGULATION.
- FAILURE TO FOLLOW THESE WARNINGS AND THE ASSEMBLY INSTRUCTIONS COULD RESULT IN SERIOUS INJURY OR DEATH.
- **NEVER** USE BED WITH CHILDREN UNDER 15 MONTHS.
- **NEVER** PLACE BED NEAR WINDOWS WHERE CORDS FROM BLINDS OR DRAPES MAY STRANGLE A CHILD.

WARNING

INFANTS HAVE DIED IN TODDLER BEDS FROM ENTRAPMENT.

- OPENINGS IN AND BETWEEN BED PARTS CAN ENTRAP HEAD AND NECK OF A SMALL CHILD.
- **NEVER** USE BED WITH CHILDREN YOUNGER THAN 15 MONTHS.
- **ONLY** USE FULL-SIZE CRIB MATTRESS OF THE RECOMMENDED SIZE.
- **ALWAYS** FOLLOW ASSEMBLY INSTRUCTIONS.

WARNING **STRANGULATION HAZARD**

- **NEVER** PLACE BED NEAR WINDOWS WHERE CORDS FROM BLINDS OR DRAPES MAY STRANGLE A CHILD.
- **NEVER** SUSPEND STRINGS OVER BED.
- **NEVER** PLACE ITEMS WITH A STRING, CORD, OR RIBBON, SUCH AS HOOD STRINGS OR PACIFIER CORDS, AROUND A CHILD'S NECK. THESE ITEMS MAY CATCH ON BED PARTS

WARNING!

- DO NOT LET ANY SHARP OBJECTS TOUCH OR RUB THE SURFACE OF THE PRODUCT.
- WHEN ASSEMBLING, DO NOT LET CHILDREN PLAY AROUND THE WORKING AREA.
- PLEASE CONFIRM ALL PARTS ARE CORRECT BEFORE STARTING THE ASSEMBLY PROCESS.
- DO NOT TIGHTEN ALL BOLTS AND SCREWS COMPLETELY UNTIL THE ENTIRE UNIT HAS BEEN ASSEMBLED AND SET UP.
- USE ONLY THE HEX WRENCH PROVIDED. **DO NOT USE POWER TOOLS. POWER TOOLS CAN OVERTIGHTEN SCREWS AND STRIP THREADS.**