

DW8210X



Product family	Dishwashers
Commercial height	82 cm
Installation	Under-Counter
N° baskets	3, Flexi
Engine	Inverter
EAN code	8017709354749



Programs



Number of programs	5	Normal	Yes
Washing temperatures	45, 50, 65, 70 °F	Rinse	Yes
Automatic	Yes	Pots & Pans	Yes
Express 60°	Si		

Options



Dry Assist+ option	Yes	Intensive washing zone option	
Professional option			

Baskets



Basket components finish	Gray	Lower basket	Fixed racks
Upper basket	Central fixed racks	Lower basket with anti-drip inserts	Yes
Upper basket height adjustment	On 3 levels	Colour Inner Components	Sage Leaf
Largest loadable dish in upper basket	25,0 inches	Cutlery basket	Yes

Technical Features



Width	23 9/16 "	Max water hardness	100°fH;58°dH
Depth	22 7/16 "	Drying system	Natural condenser drying, with Dry Assist + automatic door opening system at the end of the cycle
Height	32 3/16 "	Concealed heating element	Yes
Program symbols	Writings in English	Filter	Stainless steel
On/off indicator	Yes	Additional gaskets	Yes
Rinse aid indicator	Light	Back cover	Yes
End-of-cycle indicator	Light on display, with acoustic signal	Depth of dishwasher with open door (mm)	1146 mm
Auto switch-off	Yes	Top cover	Metal sheet
Washing system	Orbital		
Third spray arm	Single		
Turbidity sensor Aquatest	Yes		
Flood protection system	Single Aquastop		
		Min. and max plinth height	3.9" - 6.6"
		Adjustable feet	2 3/4", from 32 1/4" to 35"
		Hinges	Self-balancing with variable hinges

Electrical Connection

Connected power	1100 W	Connection type	Single-phase
Current	10 A	Power supply cable length	140 "
Voltage	115 V	Plug	(B) NEMA 5-15P
Frequency (Hz)	60 Hz		

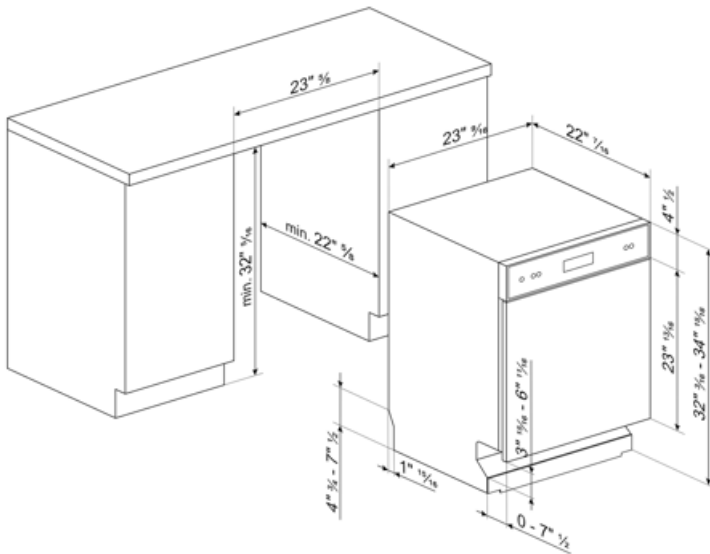

Compatible Accessories

KITJBDW



KITPL60N



Toekick Kit in Black colour with adjustable height and deepness. Can be installed over all the fully integrated and underbench models with variable fulcrum or flexifit hinges.

KITPLV2



Kit extension for dishwasher and washing machine: lenght mt. 2

KITPL60B







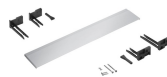







Toekick Kit in White colour with adjustable height and deepness. Can be installed over all the fully integrated and underbench models with variable fulcrum or flexifit hinges.

KITPL60X



Toekick Kit in Stainless Steel with adjustable height and deepness. Can be fitted over all the fully integrated and underbench models with variable fulcrum or flexifit hinges.

Symbols glossary

	<p>Acquastop: Some Smeg dishwashers are equipped with a simple Acquastop: float sensor in the bottom which is necessary to prevent an accidental leakage of water inside the appliance.</p>		<p>Aquatest measures the clarity of the water during an auto program, and automatically ensures the minimum consumption of water and energy.</p>
	<p>Anti-drip: Some models of dishwashers are equipped with special polymer nozzles anti-drip, that improve the process of drying.</p>		<p>COMM_HEIGHT_82_72dpi</p>
	<p>Inverter technology: The evolution of Smeg's driers towards more intelligent and environmentally sustainable models has led to the choice of using Inverter technology with heat pumps, which reduces significantly energy consumption.</p>		<p>Noise Level: Excellent insulation and special devices keep noise to a minimum.</p>
	<p>Orbital wash system distributes water evenly throughout the 60cm dishwasher cavity, directing water with precision to ensure an excellent wash.</p>		<p>Auto 45° - 65°: The auto programme regulates the length of a cycle depending on the need for a pre-wash and the number of rinses required.</p>
	<p>PRG_RINSE_72dpi</p>		<p>The symbols show the number of plate settings of the dishwasher.</p>
	<p>System WaterSave ensures the best washing results with minimal water consumption depending on the model of dishwasher.</p>		<p>...</p>
	<p>The Dry Assist + option, in addition to saving energy, ensures perfect drying of the dishes by opening the door automatically at the end of the wash c</p>		