

REGENCY

RGS
FURNITURE

LSC2935XX
Regency Legacy 29" Office Storage Cabinet

CT-SC2935XX
RGS Cornerstone 29" Storage Cabinet

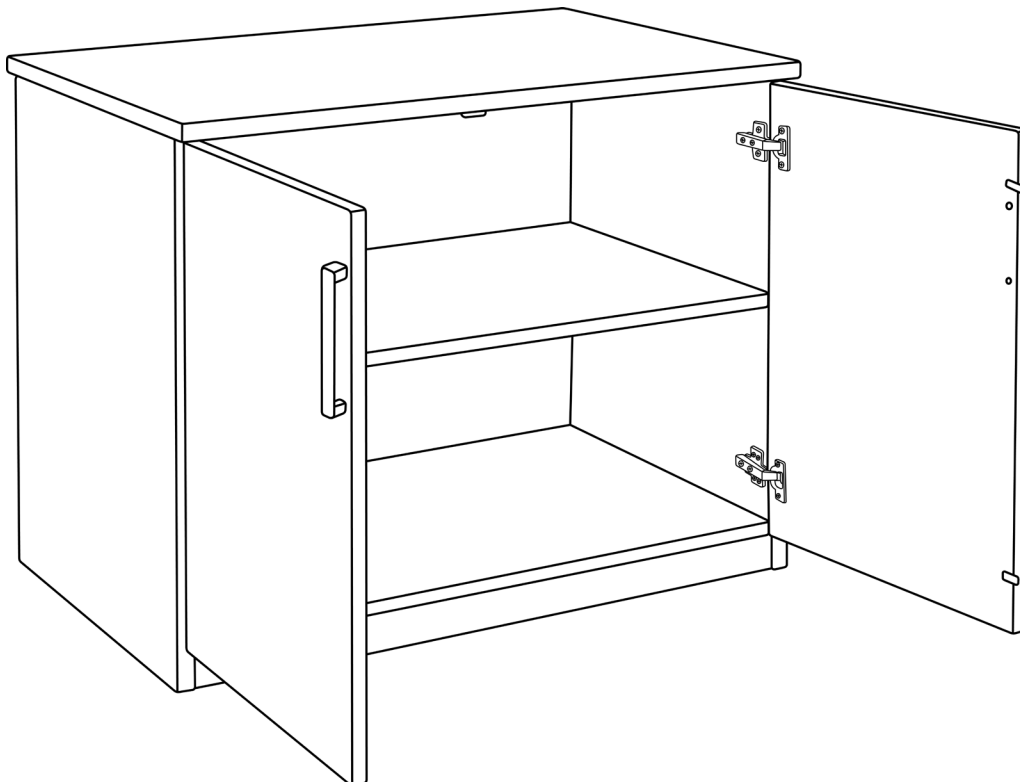
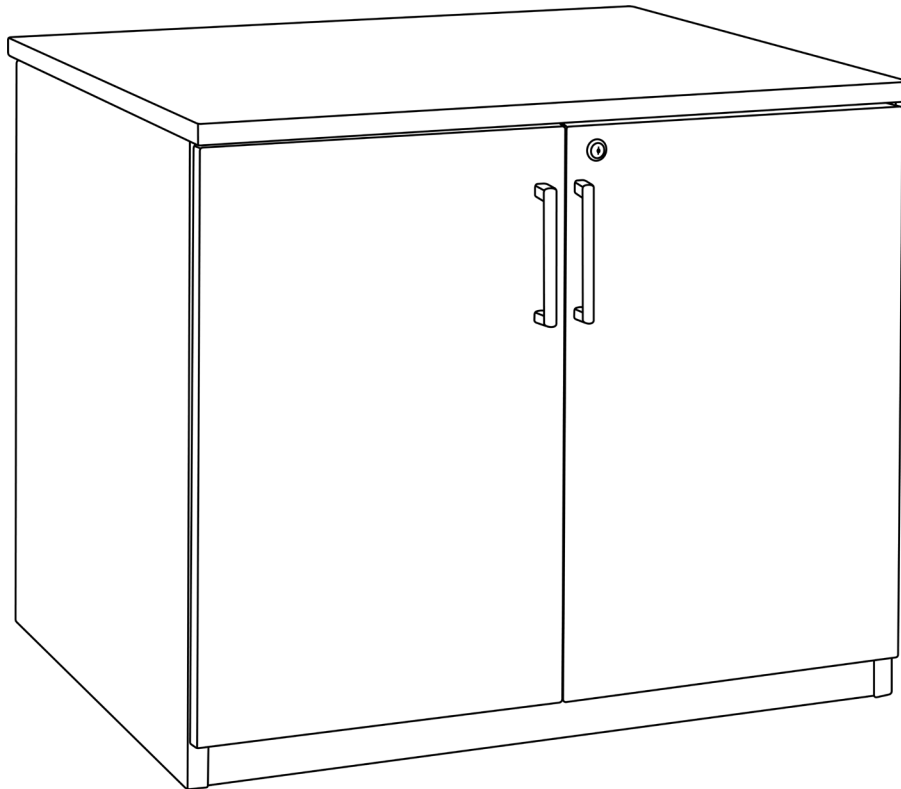









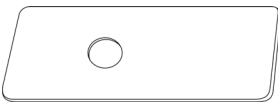
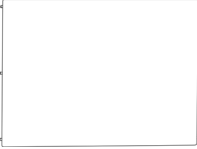

REGENCY RGS **Missing Parts? Assembly Questions?**
FURNITURE

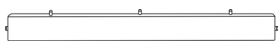
Call us at 1-866-816-9822 or email help@regencyof.com for immediate assistance.

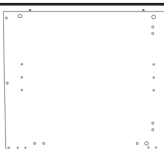
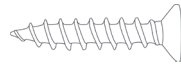
ASSEMBLY INSTRUCTIONS:

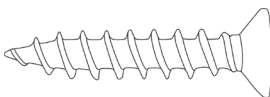
LSC2935XX
Regency Legacy 29" Storage Cabinet

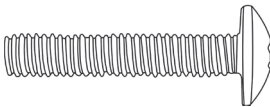
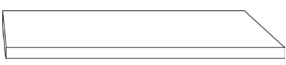
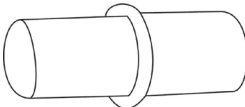
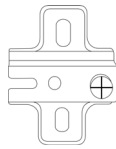
CT-SC2935XX
RGS Cornerstone 29" Storage Cabinet

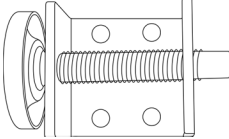
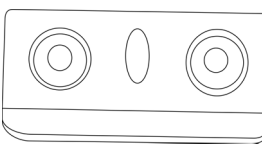
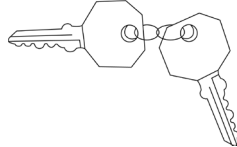
#	Part	Qty	Image	#	Part	Qty	Image
A	Top	1		K	Door Tooth	2	
B	Back Panel	1		L	Cam Pins	4	
C	Front Lip	1		M	Cam Locks	4	
D	Side Panels	2		N	Small Screws	4	
E	Bottom Panel	1		O	Medium Screws	32	
F	Doors	2		P	Large Screws	4	
G	Shelf	1		Q	Shelf Pins	4	
H	Hinge Mounting Bracket	4		R	Door Handles	2	
I	Hinge	4		S	Adjustable Glides	4	
J	Lock Lip	1		T	Keys	2	

reGENCY RGS Missing Parts? Assembly Questions?
FURNITURE

Call us at 1-866-816-9822 or email help@regencyof.com for immediate assistance.

Step 1: Place 4 Cam Locks (M) into the Top Panel (A).

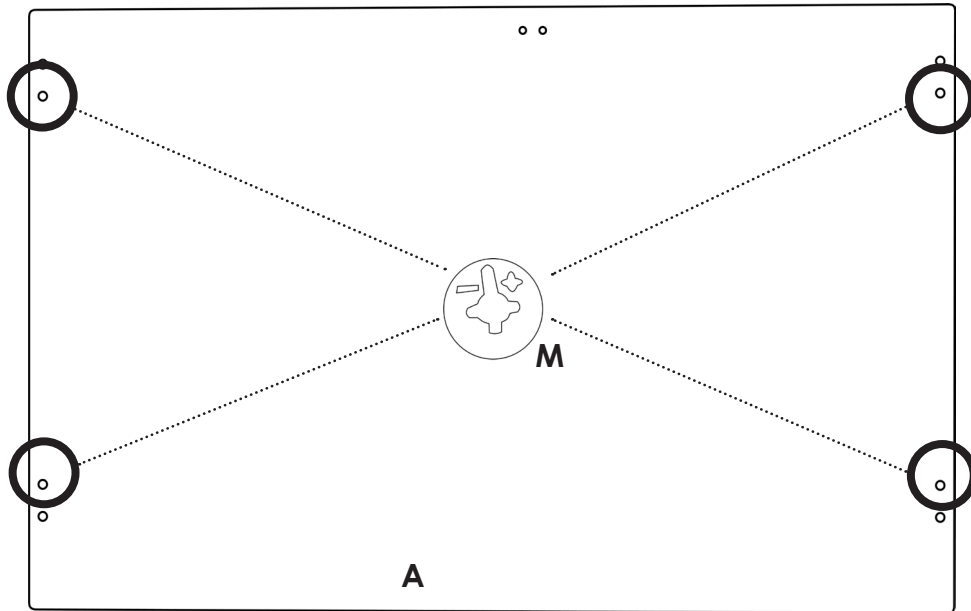

Step 2: Attach Hinge Mounting Brackets (H) to Sides (D) using pre-drilled holes with 2 Medium Screws (O) each. Also insert 2 Cam Pins (L).

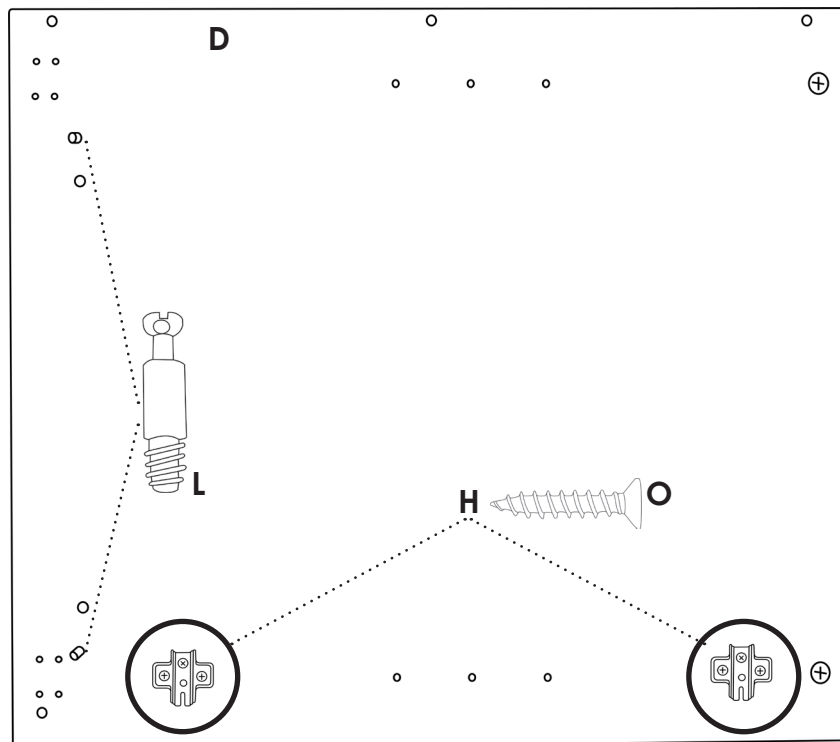

Step 3: Attach Front Lip (C) into Bottom (E) by inserting dowel rods.

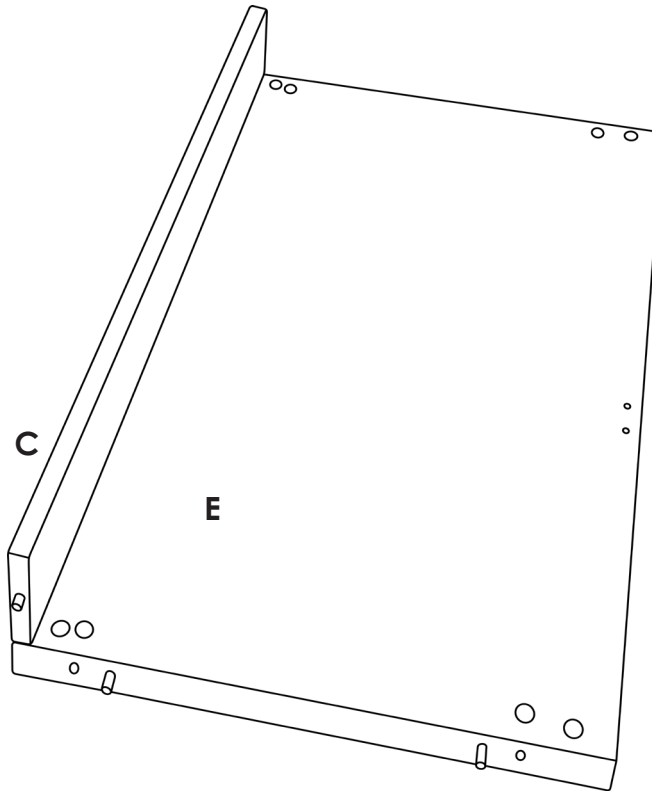

Step 4: Place Side (D) down, pins up and connect Bottom (E) by inserting Cam Pins (L) into Locks (M) and tightening.

Place Back (B) into place by inserting dowel rods into holes on Side (D).

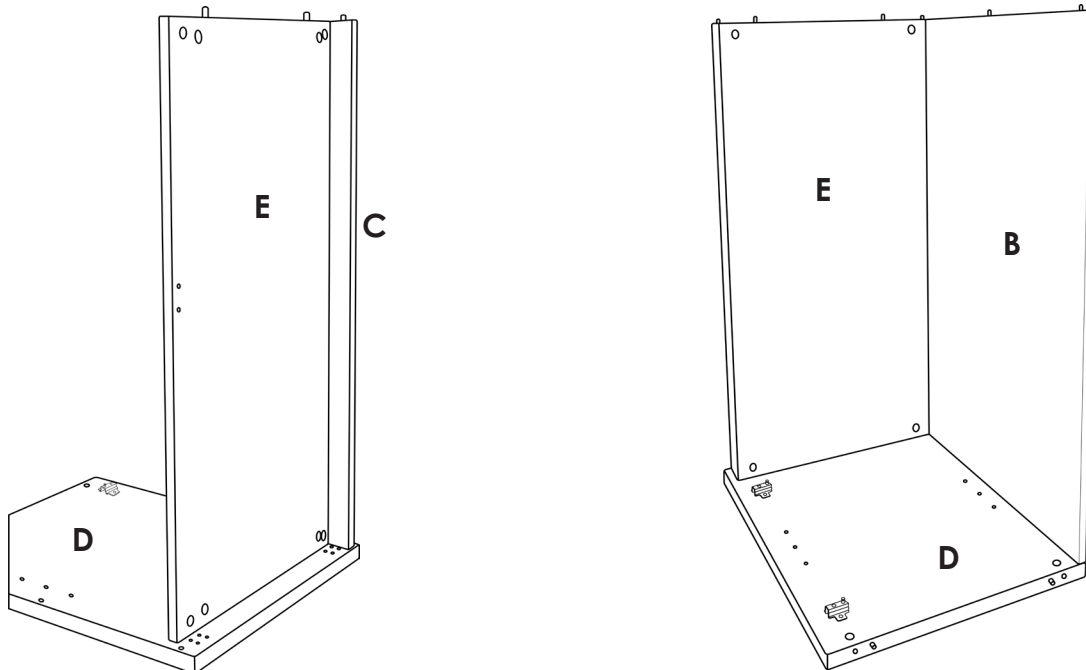

Step 5: Connect second Side (D) by inserting Cam Pins and tightening Cam Locks. Screw in Adjustable Glides (S) to Bottom (E).

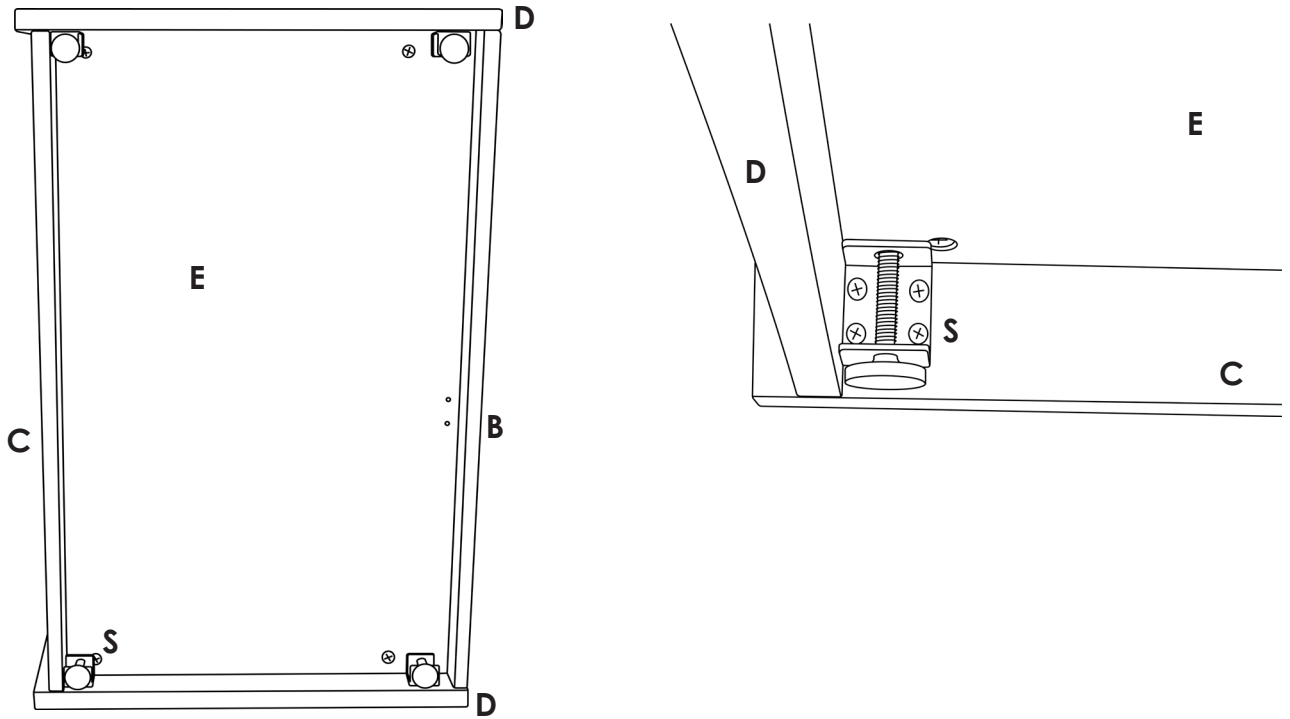

Step 6: Place Shelf Pins (Q) at desired levels and insert Shelf (G).

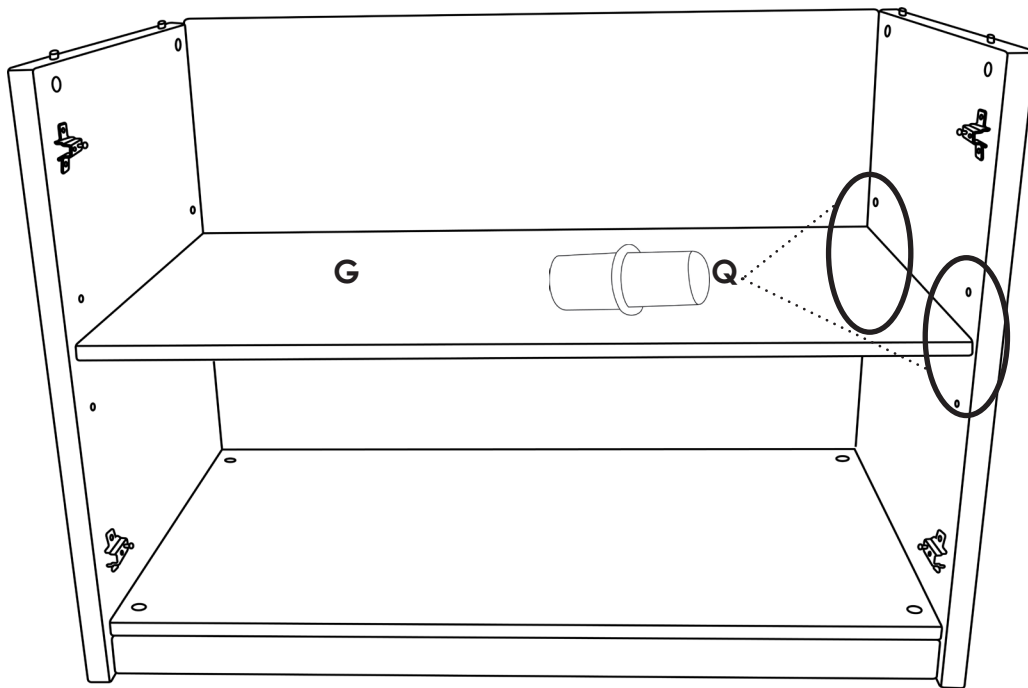

Step 7: Place Top (A) onto unit by inserting Cam Pins into Locks and tightening.

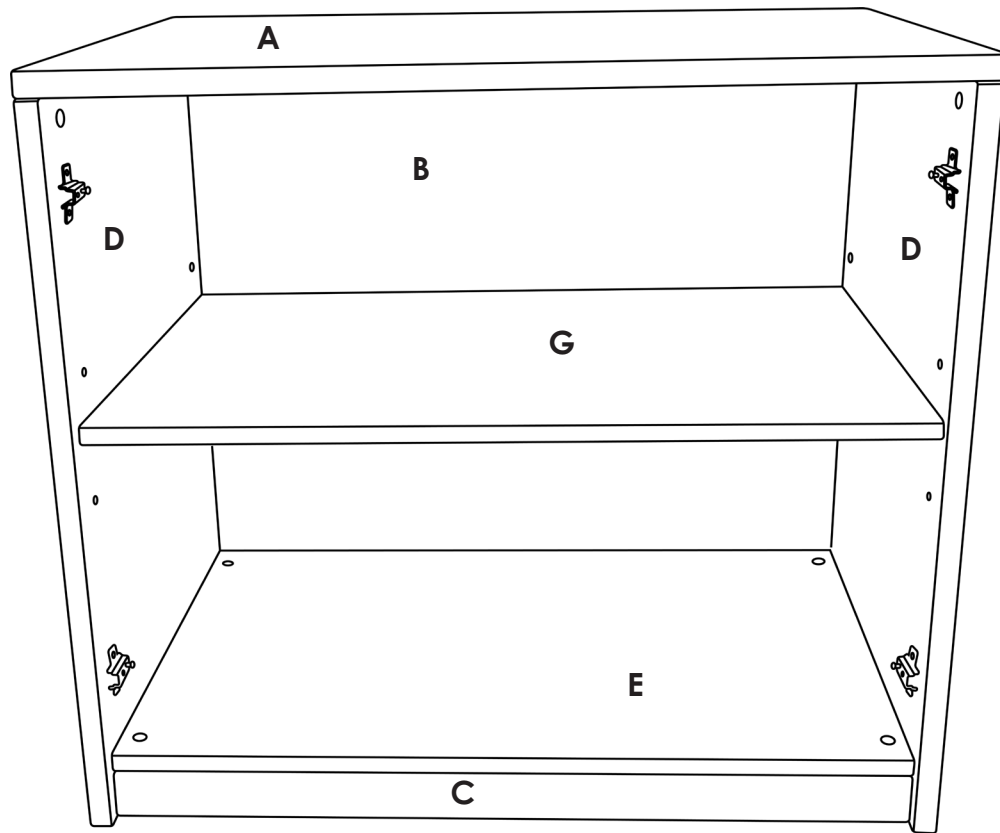

Step 8: Attach Handles (R) to Doors (F) by inserting 2 Large Screws (P) through existing holes in the Door and tightening the Handles to the Doors.

Inside of Doors

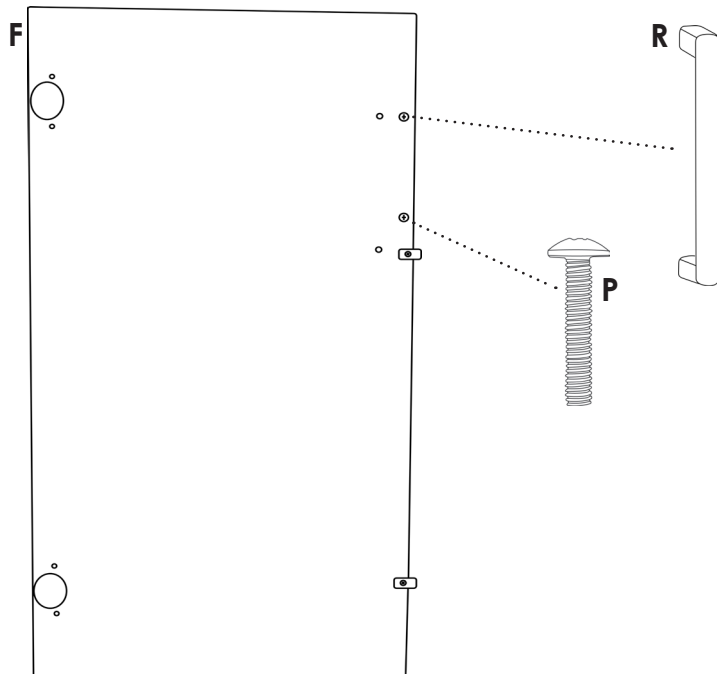

Outside of Doors

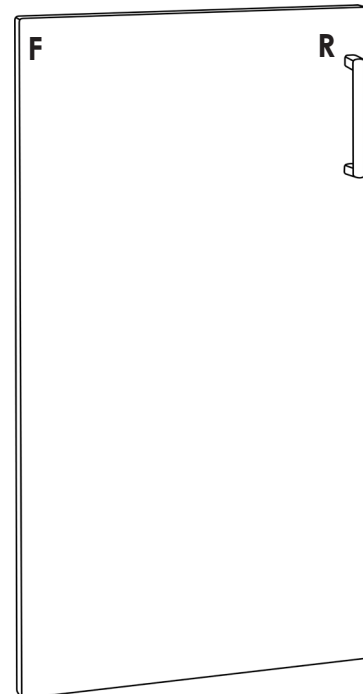

Step 9: Connect Hinges (I) to Doors (F). Attach Door Teeth (K) to Door without locking mechanism using 2 Small Screws (N).

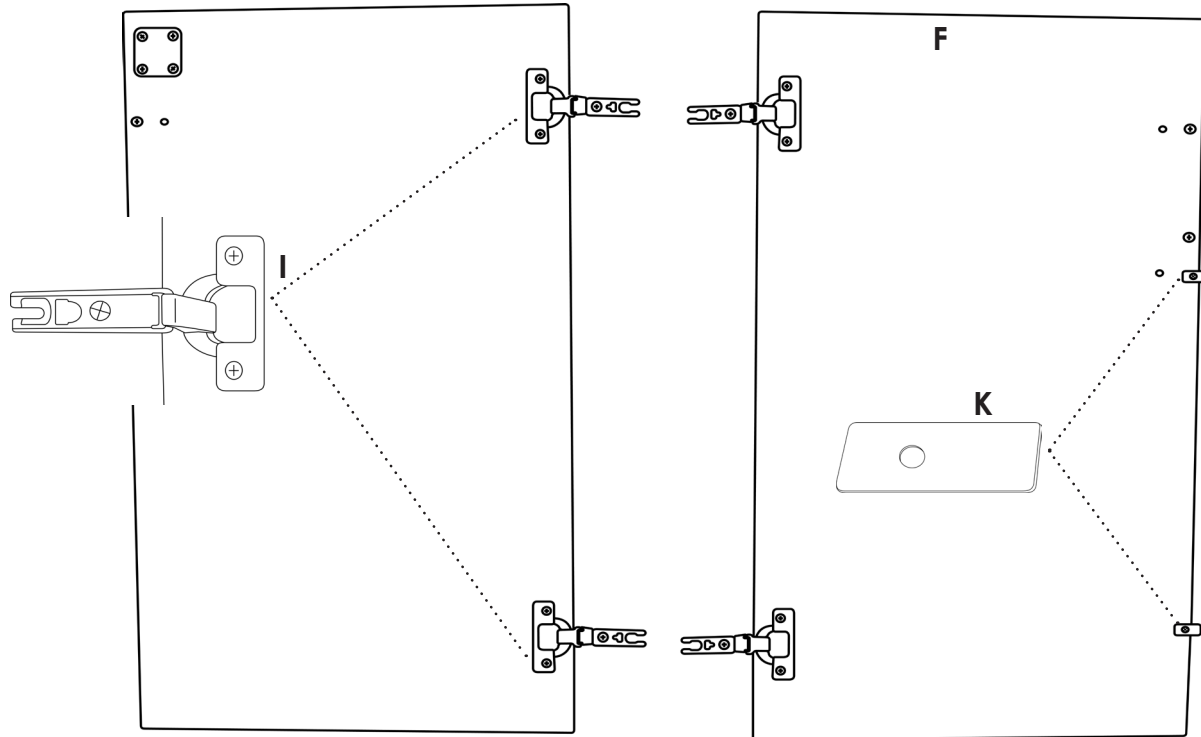

Step 10: Attach Hinges (I) to Sides (D) with 2 Medium Screws (O) each.

