



ASSEMBLY INSTRUCTIONS

ITEM NO : B3500-1 / B3500-11
KINKAID DRESSER & MIRROR

BOX OF MIRROR

ITEM	DRAWING	DESCRIPTION	QTY
A		DRESSER TOP	1
B		DRESSER TOP SUPPORT RAIL	2

BOX OF DRESSER

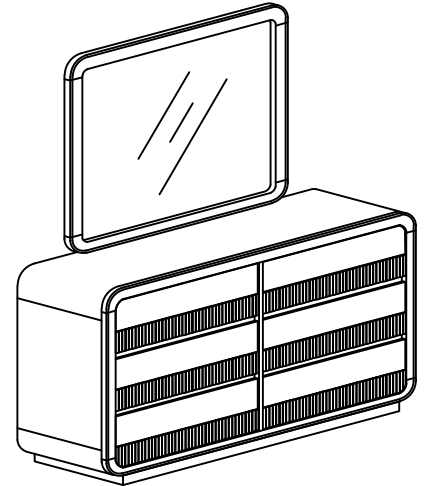

ITEM	DRAWING	DESCRIPTION	QTY
A		DRESSER	1



COMPLETED DRESSER & MIRROR ASSEMBLY

BOX OF MIRROR

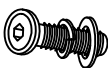
HARDWARE LIST

ITEM	DRAWING	DESCRIPTION	QTY
1		JCBC BOLT WITH SPRING WASHER AND FLAT WASHER (M6 x 35mm)	8
2		ALLEN KEY (M4)	1

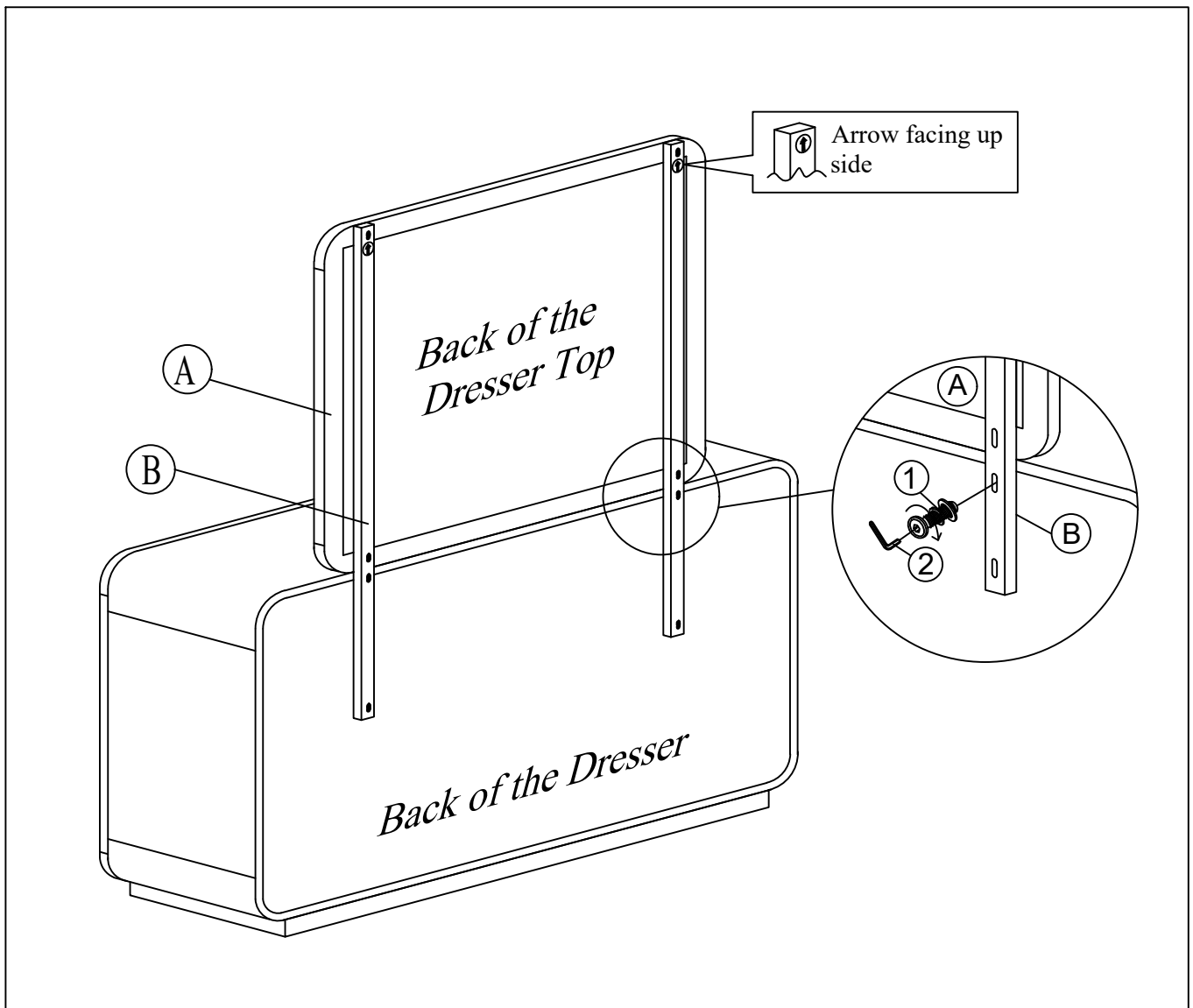

THE HARDWARE IS LOCATED IN THE PACKING ITEMS

NOTE : Periodically check to ensure that all connectors (bolts, screws, etc.) are tight.

CLEANING INSTRUCTION

After assembled, clean & polish the completed parts if necessary with soft cloth and industrial recognized furniture polish

MADE IN MALAYSIA