

**IMPORTANT INSTRUCTIONS
SAVE THESE INSTRUCTIONS**

**INSTRUCTIONS IMPORTANTES
CONSERVEZ LES PRÉSENTES INSTRUCTIONS**

**INSTRUCCIONES IMPORTANTES
REPASE Y GUARDE ESTAS INSTRUCCIONES
LEA ESTE INSTRUCTIVO ANTES DE UTILIZAR EL APARATO**

**ISTRUZIONI IMPORTANTI
CONSERVARE LE ISTRUZIONI**

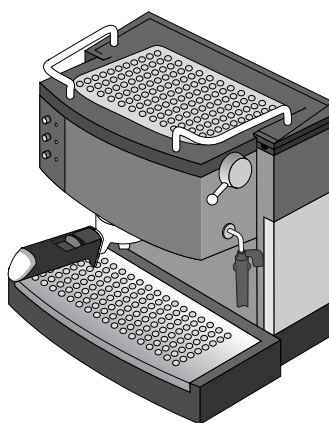

**EC-701 AND EC-702 ESPRESSO AND CAPPUCCINO MAKER/ CAFETERIE
MODÈLE EC-701 ET EC-702 / CAFETERA ELECTRICA MODELO EC-701 Y EC-
702 / MACCHINA DA CAFFÈ EC-701 E EC-702**

Register this product on-line and receive a free trial issue of Cook's Illustrated. Visit www.delonghiregistration.com.
Visit www.delonghi.com for a list of service centers near you. (U.S. and Canada only)

Enregistrez ce produit en ligne et recevez un numéro gratuit de Cook's Illustrated. Visitez www.delonghiregistration.com.
Visitez www.delonghi.com pour y voir une liste des centres de réparation proches de chez vous. (É.-U. et Canada).

Registre este producto en línea y reciba un ejemplar gratis de Cook's Illustrated. Visite www.delonghiregistration.com.
Visite www.delonghi.com para ver la lista de centros de servicios cercanos a usted. (Estados Unidos y Canada)

Registra questo prodotto "on-line" per ricevere una copia omaggio della rivista "Cook's Illustrated". Visita www.delonghiregistration.com.
Visita www.delonghi.com per una lista dei centri di servizio a te più vicini. (Stati Uniti e Canada)

**ELECTRICAL CHARACTERISTICS: CARACTÉRISTIQUES ÉLECTRIQUES:
CARACTERISTICAS ELECTRICAS: CARATTERISTICHE ELETTRICHE:
120 V ~ 60 Hz 1100W**

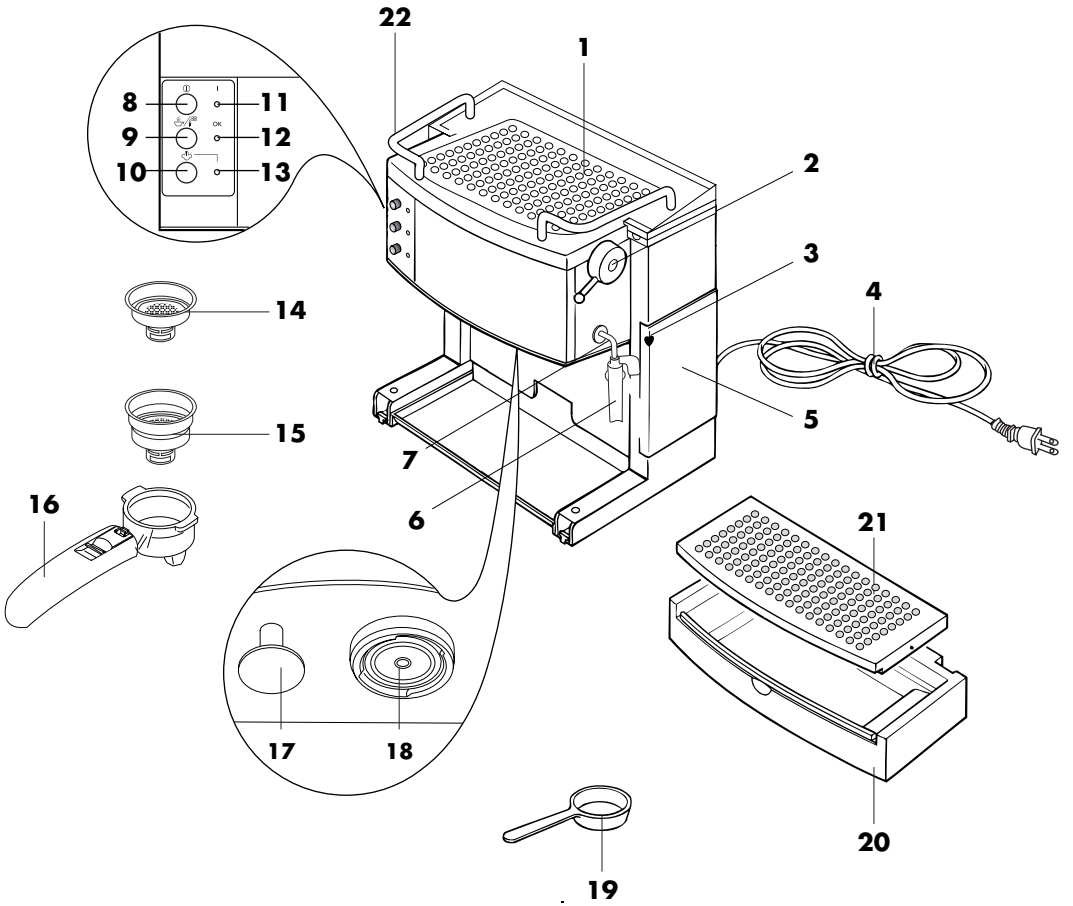

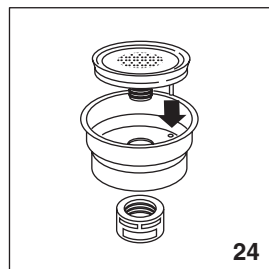
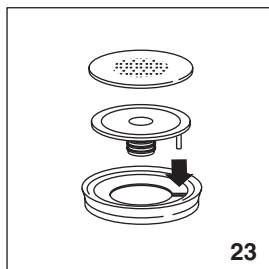
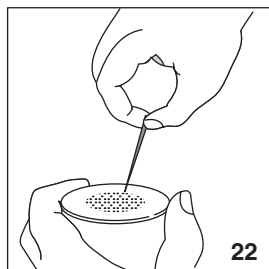
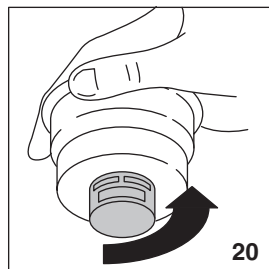
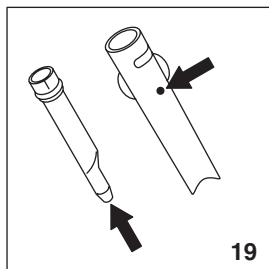
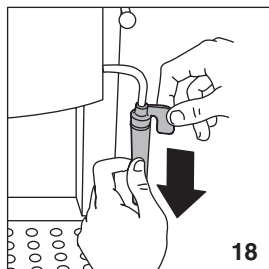
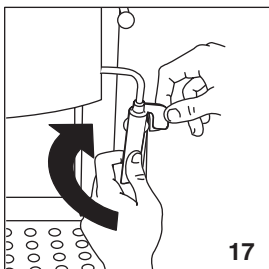
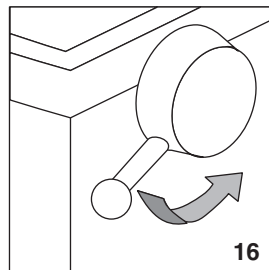
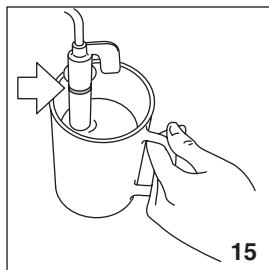
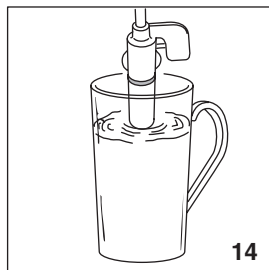
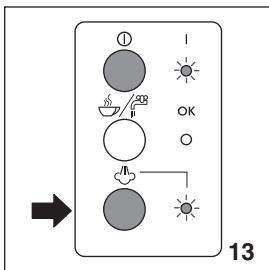
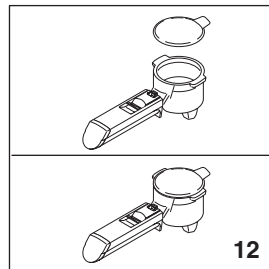
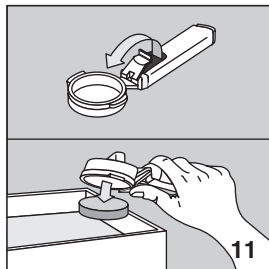
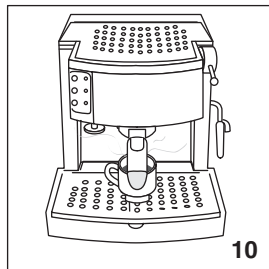
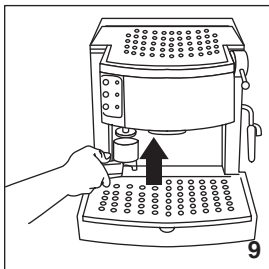
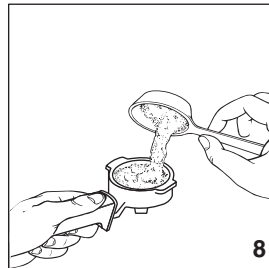
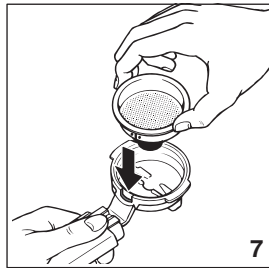
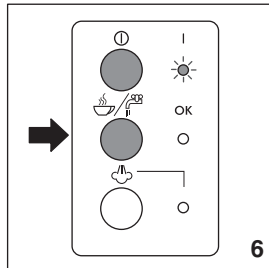
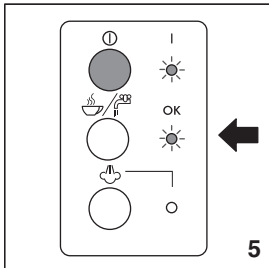
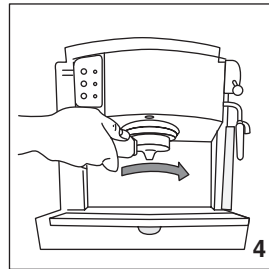
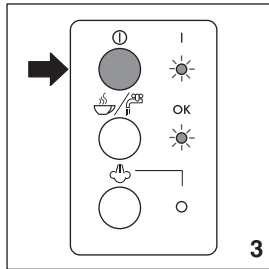
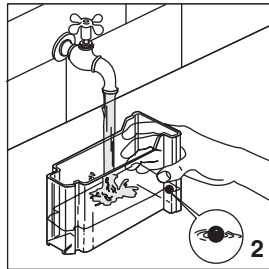
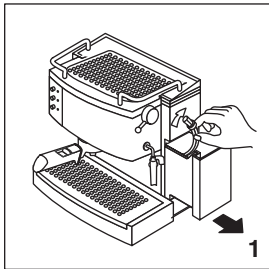

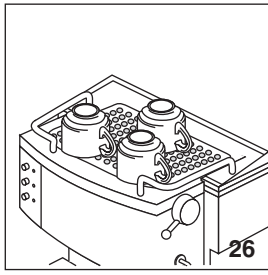
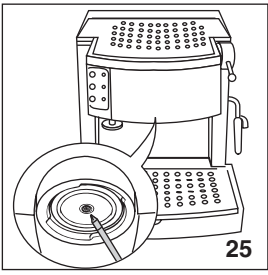



IMPORTANT SAFEGUARDS

When using electrical appliances, basic safety precautions should always be followed, including the following:

- Read all instructions.
- Do not touch hot surfaces. Use handles and knobs.
- To protect against fire, electrical shock and personal injury, do not immerse cord, plug or appliance in water or other liquid.
- Never allow the appliance to be used by children.
- Unplug from the outlet when not in use and before cleaning. Allow to cool before fitting or taking off parts, and before cleaning the appliance.
- Do not operate with a damaged cord or plug, or after the appliance malfunctions, or has been damaged in any manner. Return the appliance to the nearest authorized service facility for examination, repair or adjustment.
- The use of accessory attachments or spare parts not recommended by the appliance manufacturer may result in fire, electrical shock or personal injury.
- Do not use outdoors.
- Do not let the cord hang over the edge of the table or counter, or touch hot surfaces.
- Do not place on or near a hot gas or electrical burner, or in a heated oven.
- Plug cord into the wall outlet. To disconnect, turn any control to "off", then remove plug from wall outlet.
- Do not use the appliance for other than the intended use. This appliance is to be utilized for domestic use only. Any other use is to be considered improper and, therefore, dangerous.

SAVE THESE INSTRUCTIONS

THIS PRODUCT IS FOR HOUSEHOLD USE ONLY

SHORT CORD INSTRUCTIONS

- A short power cord is provided to reduce risks resulting from becoming entangled in or tripping over a longer cord.
- Longer, detachable power supply cords or extension cords are available and may be used if care is exercised in their use.
- If an extension cord is used, the marked electrical rating should be at least as great as the electrical rating of the appliance. If the appliance is provided with 3- wire, grounding type cord, the extension should be a GROUNDING TYPE 3 - WIRE CORD. The longer cord should be arranged so that it will not drape over the counter-top or table top where it can be pulled on by children or tripped over.
- Your product is equipped with a polarized alternating current line plug (a plug having one blade wider than the other). This plug will fit into the power outlet only one way. This is a safety feature. If you are unable to insert the plug fully into the outlet, try reversing the plug. If the plug should still fail to fit, contact your electrician to replace your obsolete outlet. Do not defeat the safety purpose of the polarized plug.

Read this instruction booklet carefully before installing and using the appliance. This is the only way to ensure the best results and maximum safety for the user.

DESCRIPTION

(see page 3)

The terminology below will be used repeatedly on the following pages.

- 1 Cup storage tray
- 2 Steam knob
- 3 Water level indicator
- 4 Power cord
- 5 Water tank
- 6 Patented cappuccino system frother
- 7 Steam tube
- 8 ON/OFF button
- 9 Coffee/hot water button
- 10 Steam button
- 11 ON/OFF indicator light
- 12 Preheating completed indicator light
- 13 Steam indicator light
- 14 Small filter for 1 cup ground coffee or 1 pod
- 15 Large filter for 2 cups ground coffee
- 16 Patented dual-function filter holder
- 17 Tamper
- 18 Boiler outlet
- 19 Measuring scoop
- 20 Removable drip tray
- 21 Removable cup support
- 22 Cup tray bars

SAFETY WARNINGS

- This appliance is designed to "make espresso coffee" and "hot drinks". Use with care to avoid scalds from the water and steam jets or through incorrect use.
- Never touch hot parts.
- After removing the packaging, make sure the product is complete. If in doubt, do not use the appliance and contact a professionally qualified person.
- The packing elements (plastic bags, polystyrene foam, etc.) should be kept out of reach of children as they are a safety hazard.
- This appliance is intended for domestic use only. Any other use is considered improper and thus

dangerous.

- The manufacturer cannot be held responsible for any damage caused through incorrect, wrong or unreasonable use.
- Never touch the appliance with wet or damp hands.
- Never let children use the appliance without supervision.
- Never allow children to play with the appliance.
- Should the appliance break or not function correctly, turn it off and do not tamper with it. For all repairs, contact authorized service centers only and insist on the use of original spare parts.
Failure to respect the above could reduce the safety of the appliance.
- The power cord for this appliance must not be replaced by the user as this operation requires the use of special tools. In the event of damage, contact an authorized service center only to avoid all risks.

INSTALLATION

- Place the appliance on a work surface away from water faucets and sinks.
- Check that the voltage of the outlet corresponds to the value indicated on the appliance rating plate. Connect the appliance to an efficiently grounded electrical socket with a minimum rating of 10A only. The manufacturer declines all liability for any accidents caused by the absence of an efficient ground system.
- If the plug fitted to the appliance does not match the power socket, have the outlet replaced with a suitable type by a qualified electrician.
- Never install the appliance in environments where the temperature may reach 0°C (32°F) or lower (the appliance may be damaged if the water freezes).

HOW TO MAKE ESPRESSO COFFEE

FILLING THE WATER TANK

Remove the water tank by pulling sideways and lifting the intake tubes out of the water (fig. 1).

Rinse and fill with clean cold water (fig 2). Check the water level by viewing the floating ball. Replace the water tank in the housing, making sure the tubes are in the water.

The water tank can also be filled by extracting it just enough to pour in water directly from a jug.

PREHEATING THE COFFEE UNIT

To obtain espresso coffee at the right temperature, the coffee machine must be preheated. It is, therefore, recommended to press the ON/OFF button (fig. 3) at least 15 minutes before preparing the espresso, **making sure the filter holder is attached to the appliance** (check that the steam knob is closed).

To attach the filter holder, position it under the boiler outlet with the handle towards the left (fig. 4), push it upwards while at the same time rotating the handle towards the right. **Rotate firmly**. Wait for 15 minutes, then make the coffee as described in the following section.

Alternatively, you can preheat more rapidly by proceeding as follows:

1. Press the ON/OFF button (fig. 3) and attach the filter holder to the appliance **without adding ground coffee**.
2. Place a cup under the filter holder. Use the same cup as will be used to prepare the coffee in order to preheat it.
3. Wait for the OK indicator light to come on (fig. 5), then immediately press the coffee button (fig. 6). Run the water off until the OK indicator light goes out, then interrupt delivery by pressing the coffee button again (fig. 6).
4. Empty the cup, detach the filter holder and empty out the hot water.

(It is normal for a small and harmless puff of steam to be emitted when removing the filter holder).

HOW TO PREPARE ESPRESSO COFFEE USING THE PATENTED FILTER HOLDER FOR GROUND COFFEE

1. After preheating the appliance as described in the previous section, place the ground coffee filter in the filter holder. **Make sure the tab is correctly inserted in the slot** as shown in fig. 7, otherwise you will not be able to attach the filter holder to the appliance. The appliance comes with two filters; the small filter should be used for one coffee and the large filter for two coffees.
2. **To make a single coffee only**, place one level measure of ground coffee, about 0.24 ounces (7 grams), in the filter (fig. 8). **To prepare two coffees**, place two loosely filled measures of ground coffee (0.42 ounces/6+6 grams) in the filter. Fill the filter a little at a time to prevent the ground coffee from overflowing.

IMPORTANT: to ensure correct operation, before placing the ground coffee in the filter holder, clean the filter of residues of ground coffee from the previous infusion.

3. Distribute the ground coffee evenly and tamp lightly with the tamper (fig. 9).

Note: Correct tamping of the ground coffee is essential to obtain a good espresso. If tamping is excessive, espresso delivery will be slow and the crema will be dark. If tamping is too light, coffee delivery will be too rapid and the froth will be skimpy and light colored.

4. Remove any excess coffee from the rim of the filter holder and attach to the appliance. **Rotate firmly (fig. 4) to avoid water leaking out.**
5. Place the cup or cups under the filter holder spouts (fig. 10). It is recommended to heat the cups before making the coffee by rinsing them with a little hot water or placing them to warm on the cup storage tray for at least 15-20 minutes (fig. 26).
6. Make sure the OK indicator light (fig. 5) is on (if it is off, wait until it comes on), then press the coffee button (fig. 6). Once the required quantity of espresso has been obtained, interrupt delivery by pressing the coffee button again (fig. 6).
7. To remove the filter holder, rotate the handle from right to left.

IMPORTANT: to avoid splashes, never remove the filter holder while the appliance is delivering espresso.

8. To dispose of the used coffee, lock the filter in place using the lever incorporated in the handle then empty the grounds by turning the filter holder upside down and tapping (fig. 11).
9. To turn the coffee machine off, press the ON/OFF

button (fig. 3).

IMPORTANT: the first time the appliance is used, all accessories must be washed through by making at least five coffees without using ground coffee.

HOW TO PREPARE ESPRESSO COFFEE USING PODS

1. Preheat the appliance as described in the section "PREHEATING THE COFFEE UNIT", making sure the filter holder is attached.

NOTE: use pods conforming to the ESE standard, indicated on the pack by the following symbol:



The ESE standard is a system accepted by leading pod producers and enables espresso coffee to be prepared simply and cleanly.

2. Place the small 1 cup ground coffee or pod filter in the filter holder, making sure the filter is correctly inserted in the slot as shown in fig. 7.
3. Insert a pod, centering it as close as possible on the filter (fig. 12). Always follow the instructions on the pod packaging to position the pod on the filter correctly.
4. Attach the filter holder to the appliance. Always rotate as far as it will go (fig. 4).
5. Proceed as in points 5, 6 and 7 in the previous section.

HOW TO MAKE CAPPUCCINO

1. Prepare the espresso coffees as described in the previous sections, using sufficiently large cups.
2. Press the steam button (fig. 13) and wait for the steam indicator light to come on (fig. 13). The OK indicator light indicates that the boiler has reached the ideal temperature for steam production.
3. In the meantime, fill a container with about 3.5 ounces (100 grams) of milk for each cappuccino to be prepared. The milk must be at refrigerator temperature (not hot!). In choosing the size of the container, bear in mind that the milk increases in volume by 2 or 3 times.

NOTE: IT IS RECOMMENDED TO USE SKIM MILK AT REFRIGERATOR TEMPERATURE.

4. Place the container with milk under the cappuccino frother.
5. Dip the cappuccino frother into the container with milk (fig. 14), taking care not to immerse the raised line on the cappuccino frother (indicated by the arrow in fig. 15). Turn the steam knob at least a half turn counter-clockwise (fig. 16). Steam is given off by

the cappuccino frother, giving the milk a creamy frothy appearance. To obtain a creamier froth, dip the cappuccino frother into the milk and rotate the container with slow movements from the bottom upwards.

6. When the required temperature is reached (140°F/60°C is ideal), interrupt steam delivery by rotating the steam knob clockwise and at the same time pressing the steam button (fig. 13).
7. Pour the frothed milk into the cups containing the espresso coffee prepared previously. The cappuccino is ready. Sweeten to taste and if desired, sprinkle the froth with a little cocoa powder.

Note: To prepare more than one cappuccino, first make all the espressos then at the end prepare the frothed milk for all the cappuccinos.

IMPORTANT: always clean the cappuccino frother after use. Proceed as follows:

1. Discharge a little steam for a few seconds by rotating the steam knob (fig. 16). This empties any milk left inside the steam tube.
IMPORTANT: it is recommended to follow this procedure each time you make cappuccino to avoid milk stagnating in the steam tube.
2. With one hand, hold the steam tube firmly and with the other unscrew the cappuccino frother itself by rotating clockwise and pulling downwards (fig. 17).
3. Remove the nozzle from the steam tube by pulling it downwards (fig. 18).
4. Wash the cappuccino frother and steam nozzle thoroughly with warm water.
5. Make sure the two holes indicated by the arrows in fig. 19 are not blocked. If necessary, clean with a pin.
6. Replace the steam nozzle by inserting it onto the steam tube and rotating firmly towards the top of the tube.
7. Replace the cappuccino frother by inserting it and rotating counter-clockwise.

HOT WATER PRODUCTION

1. Turn the appliance on by pressing the ON/OFF button (fig. 3). Wait until the OK indicator light comes on (fig. 5).
2. Place a container under the cappuccino frother.
3. Press the coffee button (fig. 6) and at the same time open the steam knob. Hot water is delivered from the cappuccino frother.
4. To interrupt delivery of hot water, close the steam knob by rotating clockwise and press the coffee button again (fig. 6).

CLEANING AND MAINTENANCE

Before cleaning the outside of the appliance, always turn off, unplug from the outlet and allow to cool.

CLEANING THE FILTER HOLDER FOR GROUND COFFEE

About every 200 coffees, clean the filter holder for ground coffee as follows:

- Remove the filter from the filter holder.
- Clean the inside of the filter holder. Never wash in a dishwasher.
- Remove the cap (fig. 20) by unscrewing in the direction indicated by the arrow on the cap.
- Remove the filter from the container by pushing it from the cap end.
- Remove the gasket.
- Rinse all components and clean the metal filter thoroughly in hot water using a brush (fig. 21). Make sure the holes in the metal filter are not blocked. If necessary, clean with a pin (see fig. 22).
- Replace the filter and plastic disk on the gasket as shown in fig. 23. Make sure to insert the pin on the plastic disk into the hole in the gasket indicated by the arrow in fig. 23.
- Replace the assembly in the steel filter container (fig. 24), making sure the pin is inserted in the hole in the support (see arrow in fig. 24).
- Finally, screw on the cap.

Failure to clean as described above invalidates the warranty.

CLEANING THE BOILER OUTLET

About every 200 coffees, the espresso boiler outlet must be cleaned as follows:

- Make sure the appliance is not hot and that it is unplugged from the socket;
- Using a screwdriver, unscrew the screw fixing the espresso boiler outlet (fig. 25);
- Clean the boiler with a damp cloth;
- Clean the boiler outlet thoroughly in hot water using a brush. Make sure the holes are not blocked. If necessary, clean with a pin (fig. 22).
- Rinse under running water, rubbing all the time.
- Replace the espresso boiler outlet, making sure the gasket is correctly positioned.

Failure to clean as described above invalidates the warranty.

OTHER CLEANING OPERATIONS

1. Do not use solvents or abrasive cleaning products to clean the appliance. A soft, damp cloth is sufficient.
2. Clean the filter holder, filters, drip tray and water tank regularly.

IMPORTANT: during cleaning, never immerse the espresso maker in water. It is an electrical appliance.

DESCALING

You must descale the coffee machine about every 200 coffees.

Use the descaler provided only. To descale, proceed as follows:

1. Fill the tank with 34 ounces (1 liter) of water;
2. Pour the contents of the descaler bottle provided (250 ml) into the tank. For subsequent descaling operations, descaling solution can be purchased from authorized technical service centers.
3. Press the ON/OFF button (fig. 3) and wait for the OK indicator light to come on.
4. Make sure the filter holder is not attached and position a container under the boiler outlet.
5. Press the coffee button, half empty the tank and every now and then rotate the steam knob to allow a little of the solution to run off. Then interrupt by pressing the coffee button again.
6. Leave the solution to work for about 15 minutes, then run off the rest of the water in the tank.
7. To eliminate residues of the solution and scale, rinse the water tank well, fill with clean water and replace in its housing. Press the coffee button and operate the appliance until the water tank is completely empty;
8. Press the coffee button again and repeat the last operation.

Repair of damage to the espresso maker caused by scale **is not covered by the warranty unless descaling is performed regularly as described above.**

PROBLEM	POSSIBLE CAUSES	SOLUTION
No espresso coffee is delivered	<ul style="list-style-type: none"> • No water in the tank • The holes in the filter holder are blocked • The espresso boiler outlet is blocked 	<ul style="list-style-type: none"> • Fill the tank with water • Clean the filter holder spout holes • Clean as described in the section "Cleaning the boiler outlet"
The espresso coffee drips from the edges of the filter holder rather than the holes	<ul style="list-style-type: none"> • The filter holder is inserted incorrectly • The espresso boiler gasket has lost elasticity • The holes in the filter holder are blocked 	<ul style="list-style-type: none"> • Attach the filter holder correctly and rotate as far as it will go • Have the espresso boiler gasket replaced at a service center • Clean the holes
The espresso coffee is cold	<ul style="list-style-type: none"> • The espresso OK indicator light was not on when the coffee switch was pressed • No preheating performed • The cups were not preheated 	<ul style="list-style-type: none"> • Wait until the espresso OK indicator light comes on • Preheat as described in the section "Preheating the coffee unit" • Preheat the cups by rinsing with hot water
The pump is excessively noisy	<ul style="list-style-type: none"> • The water tank is empty 	<ul style="list-style-type: none"> • Refill the tank
The crema is too light (delivered from the spout too fast)	<ul style="list-style-type: none"> • The ground coffee is not pressed down firmly enough • There is not enough ground coffee • The ground coffee is too coarse 	<ul style="list-style-type: none"> • Tamp/Press the ground coffee down more firmly • Increase the quantity of coffee • Use ground coffee for espresso coffee machines only
The crema is too dark (delivered from the spout too slowly)	<ul style="list-style-type: none"> • The ground coffee is pressed down too firmly • There is too much ground coffee • The espresso boiler outlet is blocked • The ground coffee is too fine 	<ul style="list-style-type: none"> • Tamp/Press the coffee down less firmly • Reduce the quantity of ground coffee • Clean as described in the section "Cleaning the boiler outlet" • Use ground coffee for espresso coffee machines only
The coffee has an acidic taste	<ul style="list-style-type: none"> • Inadequate rinsing after descaling 	<ul style="list-style-type: none"> • After descaling, rinse the appliance as described in the section "Descaling"
No milk froth is formed when making cappuccino	<ul style="list-style-type: none"> • Milk not cold enough • Cappuccino maker dirty 	<ul style="list-style-type: none"> • Always use skim milk at refrigerator temperature. • Thoroughly clean the holes in the cappuccino frother



This warranty applies to all products with De'Longhi or Kenwood brand names.

Limited Warranty

What does the warranty cover?

We warrant each appliance to be free from defects in material and workmanship. Our obligation under this warranty is limited to repair at our factory or authorized service center of any defective parts or part thereof, other than parts damaged in transit. In the event of a products replacement or return, the unit must be returned transportation prepaid. The repaired or new model will be returned at the company expense. This warranty shall apply only if the appliance is used in accordance with the factory directions, which accompany it, and on an Alternating current (AC) circuit.

How long does the coverage last?

This warranty runs for one year (1) from the purchase date found on your receipt and applies only to the original purchaser for use.

What is not covered by the warranty?

The warranty does not cover defects or damage of the appliance, which result from repairs or alterations to the appliance outside our factory or authorized service centers, nor shall it apply to any appliance, which has been subject to abuse, misuse, negligence or accidents. Also, consequential and incidental damage resulting from the use of this product or arising out of any breach of contract or breach of this warranty are not recoverable under this warranty. Some states do not allow the exclusion or limitation of incidental or consequential damage, so the above limitation may not apply to you.

How do you get service?

If repairs become necessary, see contact information below:

U.S. Residents:

Please contact our toll free hotline at 1-800-322-3848 or log onto our website at www.delonghi.com.

For all accessories, spare parts or replacement parts, please contact our parts division at 1-800-865-6330.

Residents of Canada: Please contact our toll free hotline at 1-888-335-6644 or log onto our website at www.delonghi.com.

Residents of Mexico: Please refer to the Limited Warranty statement for Mexico.

Please refer to the back page of the manual for De'Longhi addresses.

The above warranty is in lieu of all other express warranties and representations. All implied warranties are limited to the applicable warranty period set forth above. This limitation does not apply if you enter into an extended warranty with De'Longhi. Some states do not allow limitations on how long an implied warranty lasts, so the above exclusions may not apply to you. De'Longhi does not authorize any other person or company to assume for it any liability in connection with the sale or use of its appliance.

How does state law apply?

This warranty gives you specific legal rights, and you may also have other rights, which vary from state to state.



De'Longhi America, Inc.

Park 80 West, Plaza One
Saddle Brook, NJ 07663
1-800-322-3848

De'Longhi Canada, Inc.

6150 McLaughlin Road
Mississauga, Ontario
L5R 4E1 Canada
1-888-335-6644

Fiducia Italiana S.A. de C.V.

Pestalozzi #814
Col. Narvarte
Del. Benito Juarez
C.P. 03100
MEXICO
tels: 5543 1447
lada sin costo: 01 800 711 8805

www.delonghi.com