

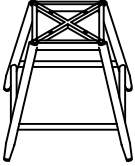



# Product Assembly Instructions

## Crown Swivel Counter or Bar Stool

<p>①  X1</p> <p>Base</p>	<p>②  X1</p> <p>Seat</p>	<p>③  X1</p> <p>Wrench</p>
<p>④  X4</p> <p>M6X15</p>	<p>⑤  X4</p> <p>M6 spacer</p>	<p>⑥  X1</p> <p>Back cushion</p>
<p>⑦  X1</p> <p>Seat cushion</p>		

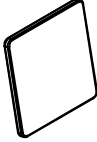
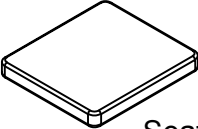
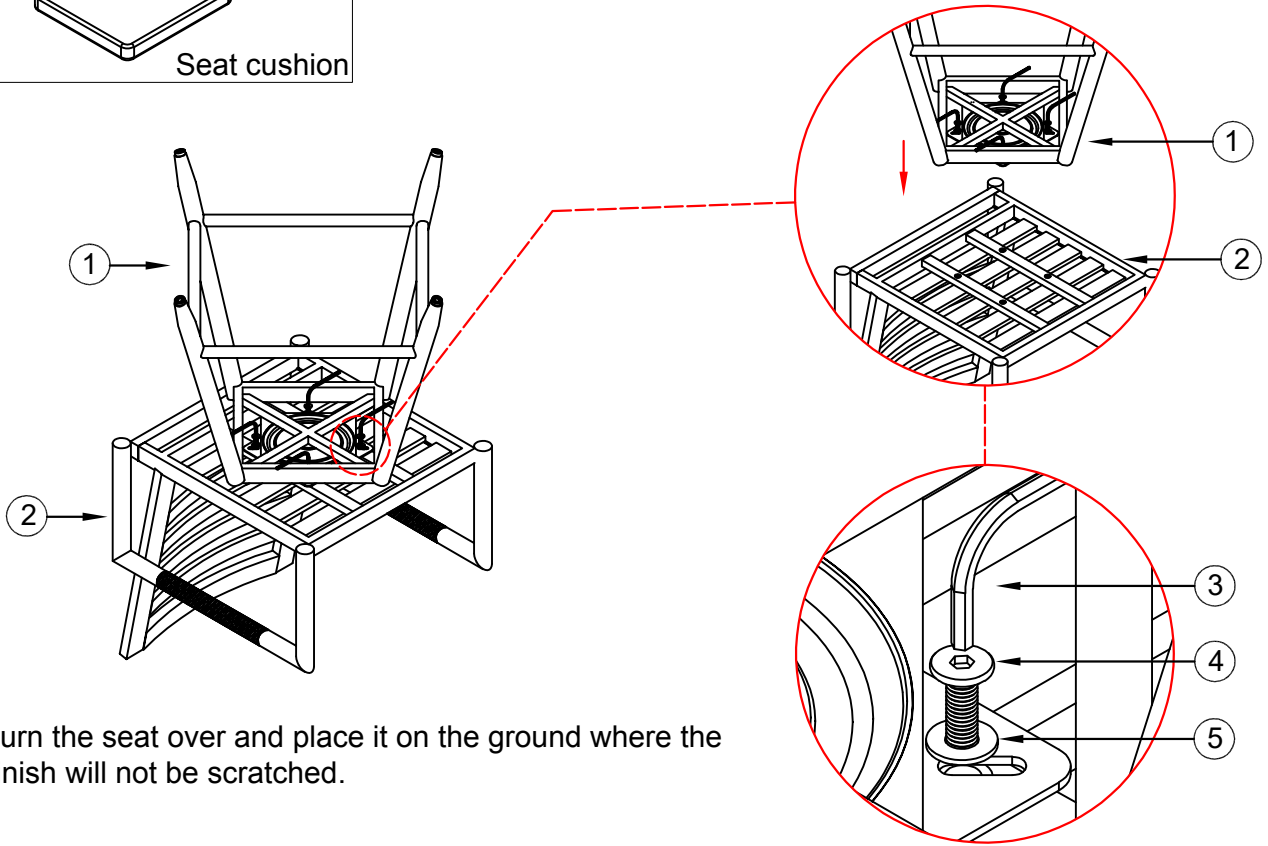

Step 1: Turn the seat over and place it on the ground where the exterior finish will not be scratched.

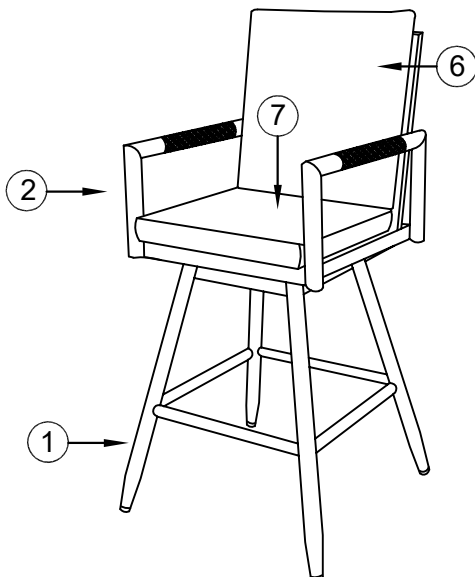

Step 2: Align the screw holes of the chair leg with the screw holes of the seat, insert flat washers(5) and screws(4) into each hole,once the screws are in place, tighten the screw until firmly attached with the wrench provided.

Step 3: Turn the chair over and put the seat cushion & back cushion on the chair.