

1A Parts in this Box

Pièces dans cette boîte

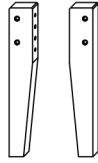

Footboard Rail
Rails de pied de lit **x 2**



Footboard Legs
(Left & Right Hand)
Patte de pied de lit
(Gauche et Droit)
x 2 Pairs

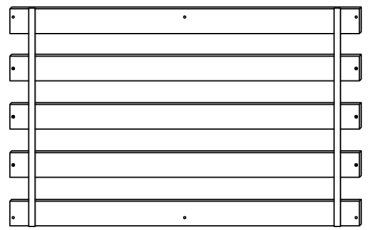
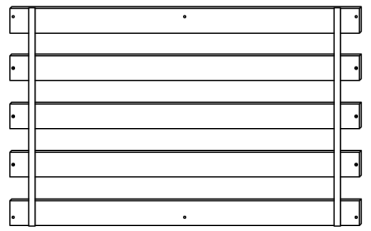

Set of Slats
Ensemble de lattes
x 2

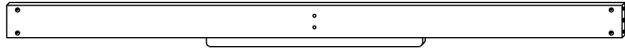

Center Rail
Rail du centre **x 1**



Center Leg
Patte du centre **x 1**

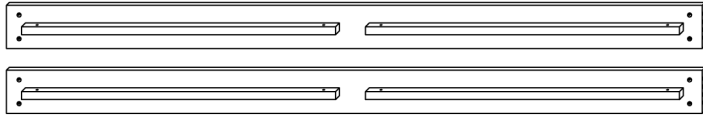

Stretcher
Rails d'étiement **x 2**

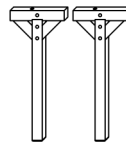

Legs
Pattes **x 2**

1B Hardwares in this box

Quincaillerie incluse

Scale 1:1

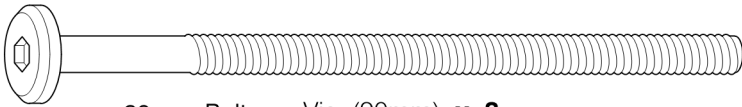

90mm Bolt Vis (90mm) **x 8**

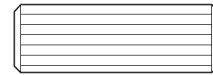

Wood Dowel
Goujon de bois **x 18**

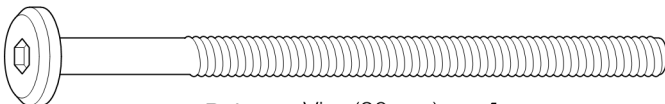

80mm Bolt Vis (80mm) **x 4**



M6 Wing Nut
Écrou (M6) **x 2**

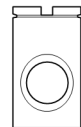

Barrel Nut
Écrou **x 12**

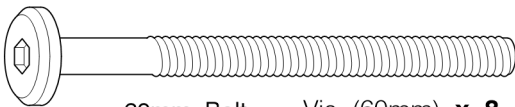

60mm Bolt Vis (60mm) **x 8**

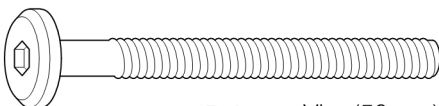

50mm Bolt Vis (50mm) **x 2**



Plastic Washer
Rondelle en
plastique **x 8**

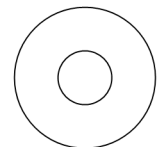

Washer
Rondelle **x 4**

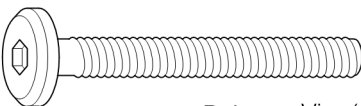

40mm Bolt Vis (40mm) **x 2**

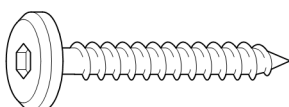

30mm Threaded Wood Bolt
Vis à bois (30mm) **x 8**

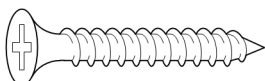

30mm Wood Screws
Vis à bois (30mm) **x 12**



Long Allen Key
Longue clef allen **x 1**

2A Assemble the Footboard Rail to the Footboard Leg
Assembler les pattes aux rails de pied de lit

x2

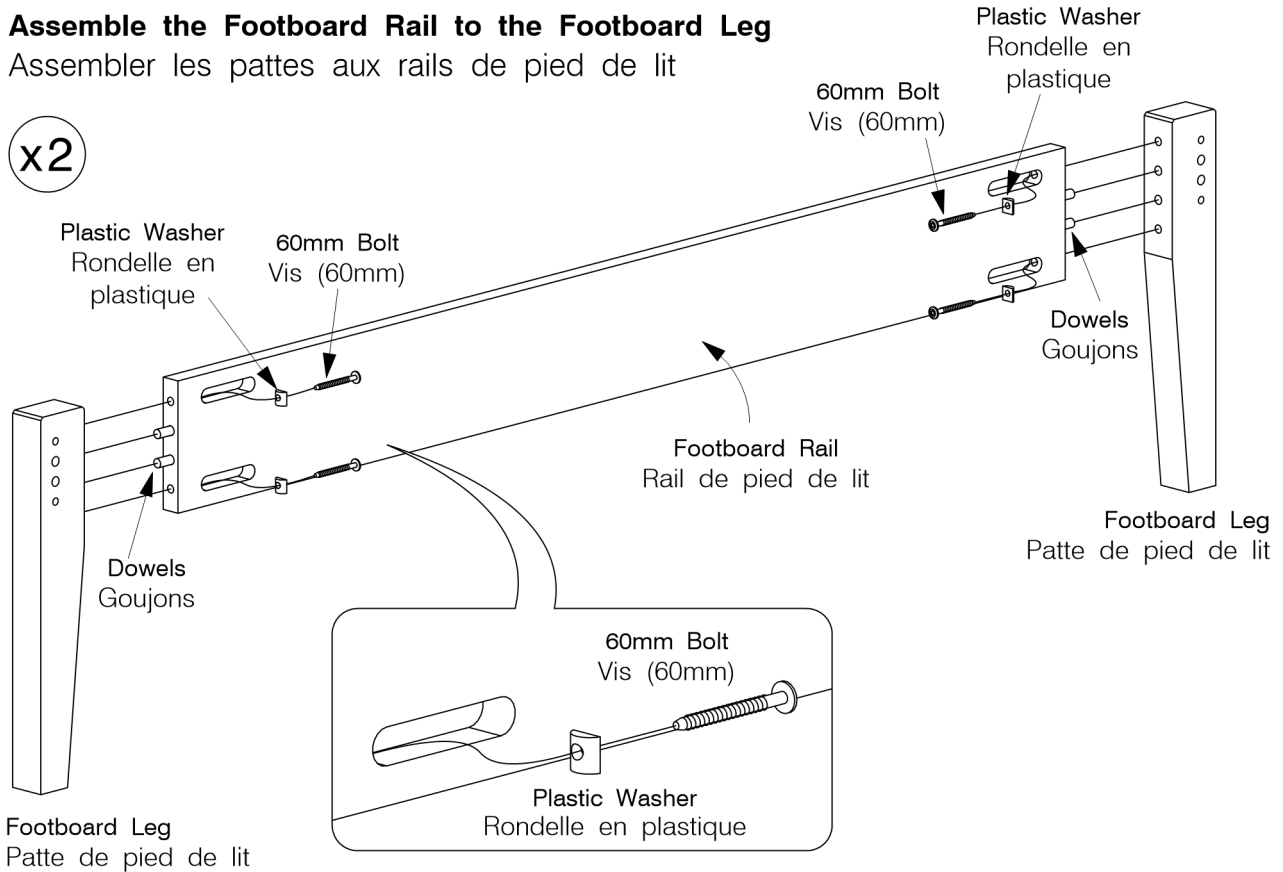

2B Attach the Rails to the Footboard
Attacher les rails au pied de lit

✓ **Leave the Bolts a bit loose, so it is easier to align the slats. Only after everything is put together should you tighten all the Bolts.**

Laisser les vis un peu lâche pour faciliter l'alignement des lattes. Une fois le tout mis en place serrer toutes les vis.

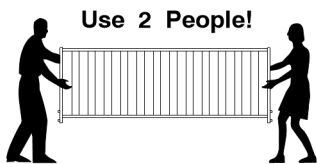
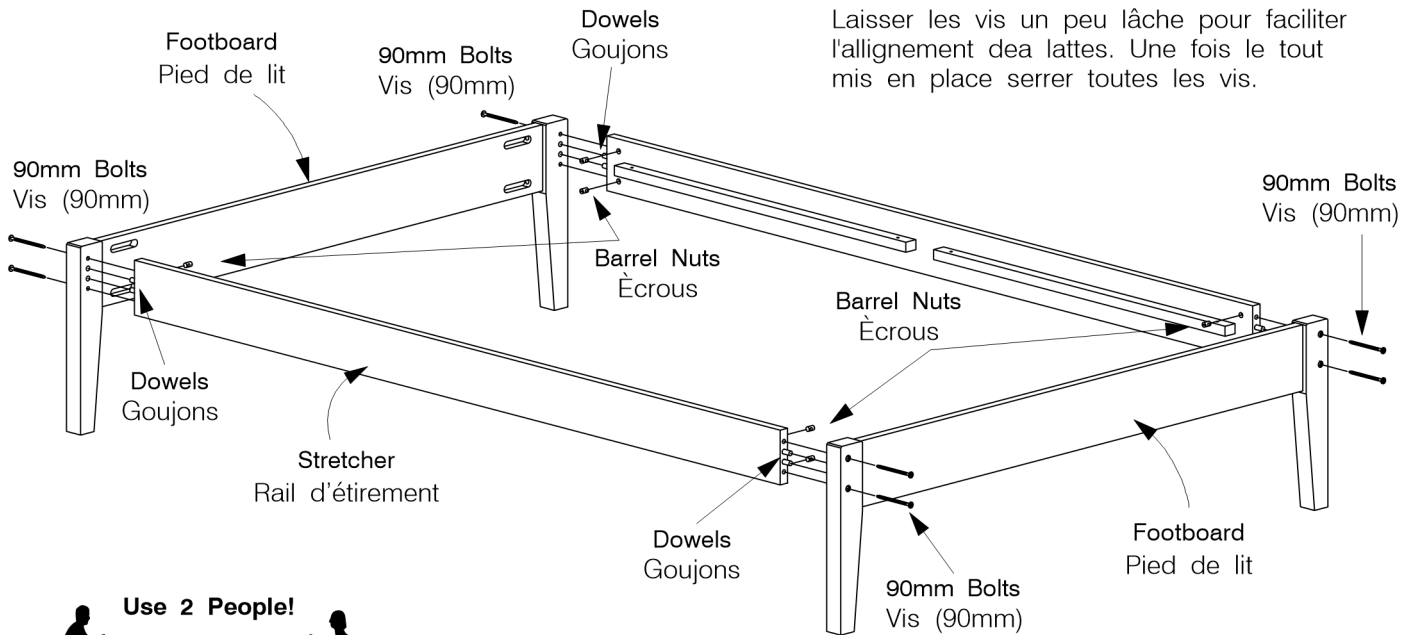

Il faut être 2 personnes!

3A Fit the Legs to the Center Rail
 Adjuster les pattes au rail central

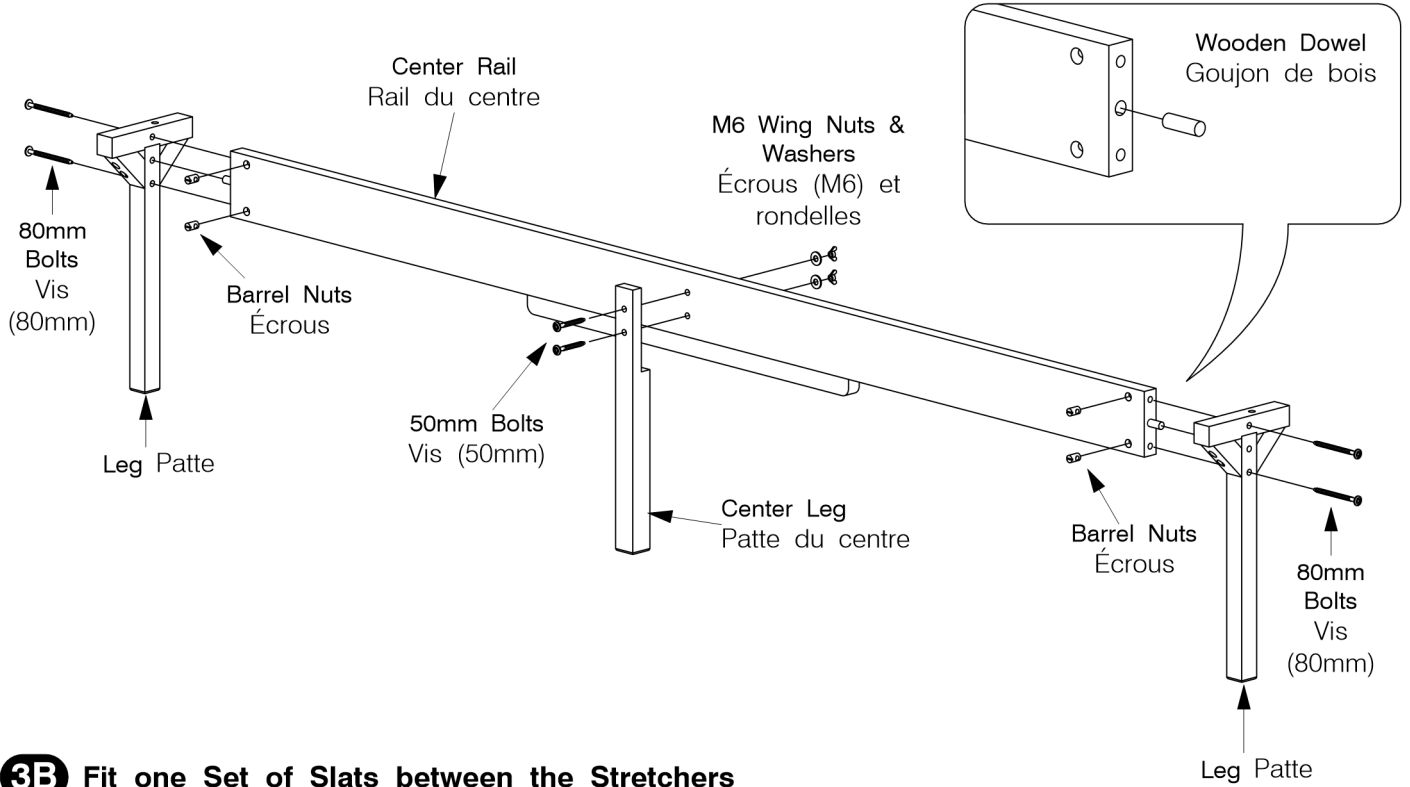

3B Fit one Set of Slats between the Stretchers
 Mettre en ensemble de lattes entre les rails d'étirement

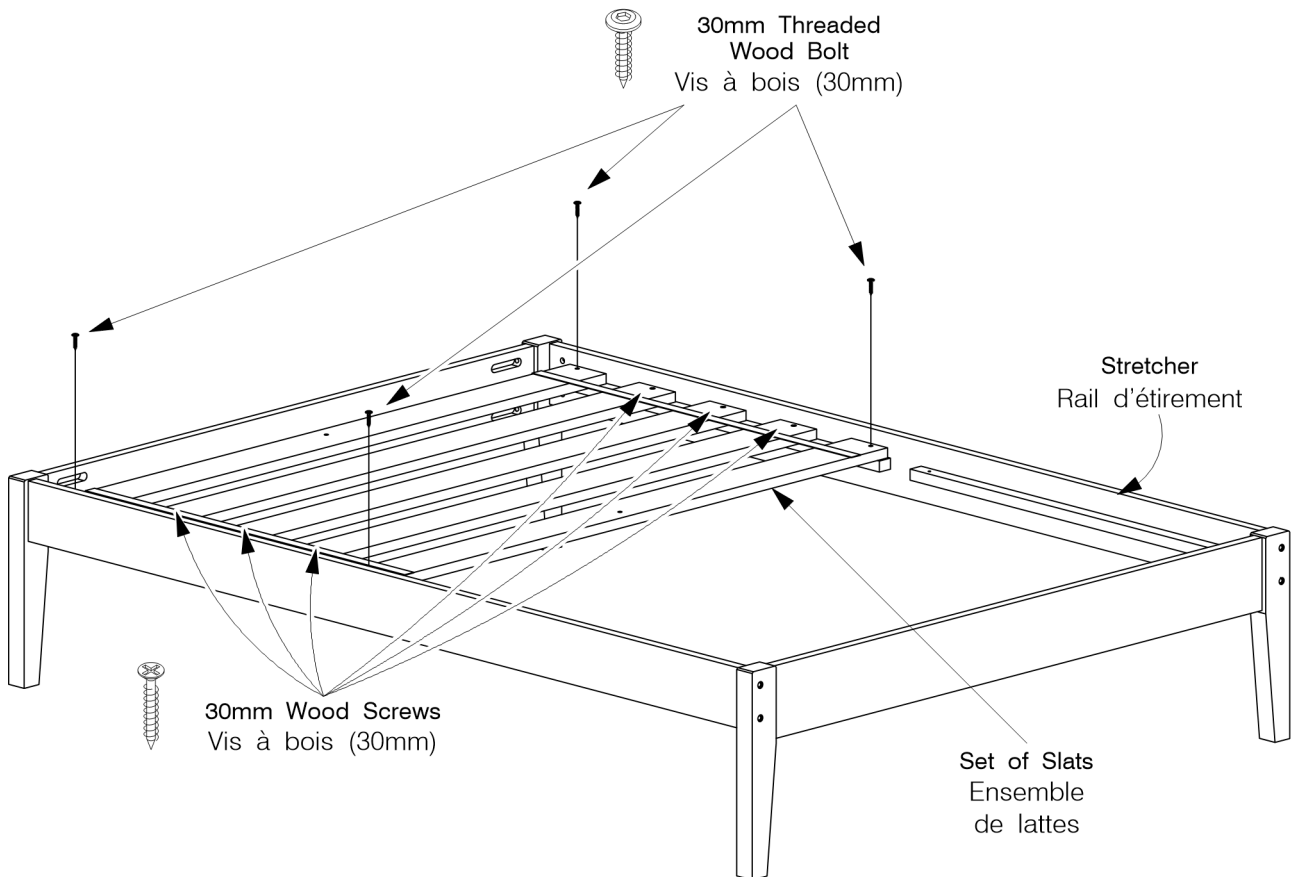

4A Fix the Legs to the Center Rail
 Adjuster les pattes au rail central

Position the Center Rail with the Legs beneath the Slats. Line up the hole in the Center Rail with the center hole in the Slat. Bolt it in place with a 40mm Bolt & Washer.

Positionner le rail du centre avec les pattes en dessous des lattes. Aligner le trou du rail du centre avec le trou des lattes. Les visser en place avec une Vis (40mm) et rondelle.

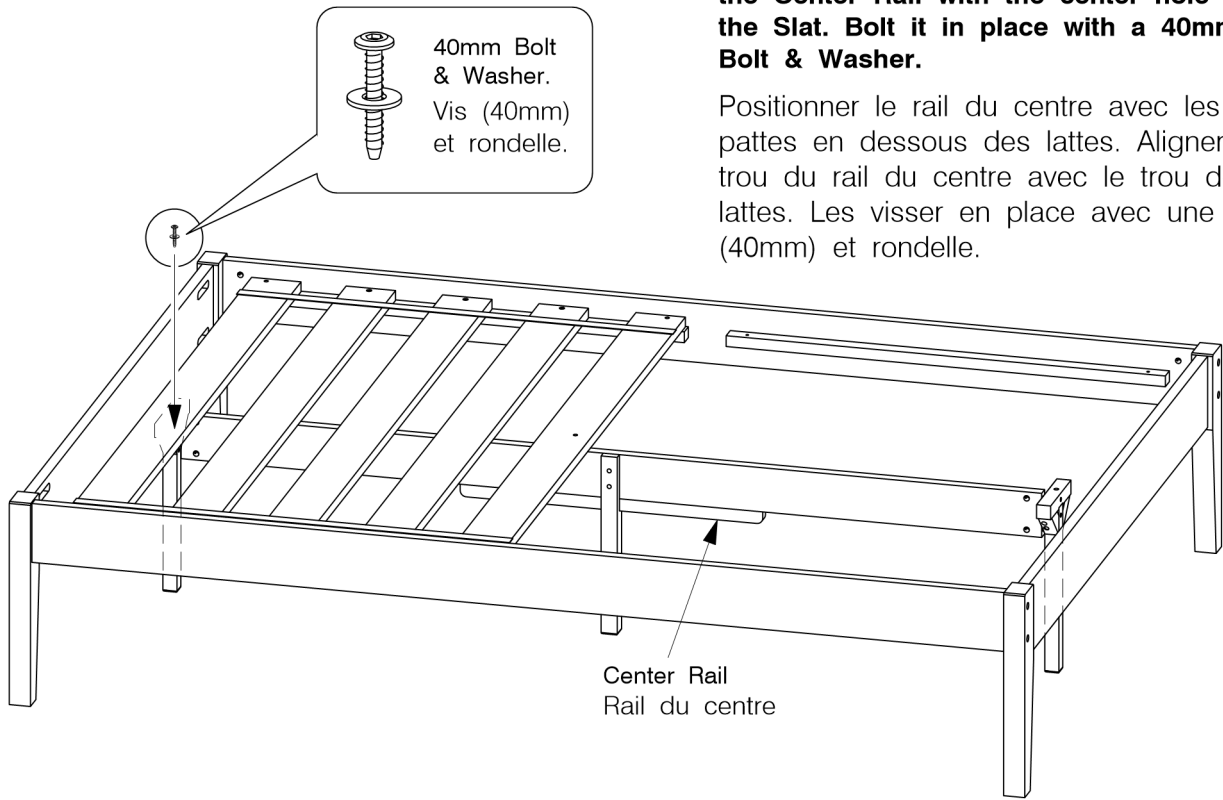

4B Fit the other Set of Slats between the Stretchers
 Mettre l'autre ensemble de lattes entre les rails d'étirement

✓ **NOTE: All Slats must be screwed down.**
 NOTE: Il est essentiel de vissez toutes les lattes.

