

**LG LAUNDRY**

# DLE7100W / DLG7101W

## 7.3 cu.ft. Rear Control Top Load Dryer



**Ultra Large 7.3 cu. ft. Capacity**

**Sensor Dry System**

**Electronic Control Panel with Dual LED Display**

**Wrinkle Care Option**

**SmartDiagnosis™**

**3-Minute Smart Installation Check**

**FlowSense™ Duct Clogging Indicator**

**LoDecibel™ Quiet Operation**

SUMMARY	
Capacity	7.3 cu ft
Matching Washer	WT7100CW
Sensor Dry	Yes
Color	White (W)
APPEARANCE	
Intelligent Electronic Controls with LED Display	Yes
Dial-A-Cycle™	Yes
DRYER PROGRAMS	
No. of Programs	8
Programs (Sensor Dry)	Cotton/Normal, Perm Press/Casual, Heavy Duty, Bulky/Bedding, Delicates, Speed Dry (Manual Dry), Air Dry (Manual Dry), Freshen Up (Manual Dry)
DRYER OPTIONS	
No. of Options	7
Options	Soak, Extra Rinse, Add GarWrinkle Care, Control Lock, More Time, Less Time, Damp Dry Signal, Energy Saver, Default On/Off
DRYER DETAILS	
Temperature Settings	3
Drying Levels	3
Manual Dry Times	60, 40, 20 min, More-Less
FABRIC CARE FEATURES	
Sensor Dry	Yes
Precise Temperature Control with Variable Heater	Yes

CONVENIENCE FEATURES	
SmartDiagnosis™	Yes
3 Minute Installation Check	Yes
LoDecibel™ Quiet Operation	Yes
End of Cycle Signal	Yes
Reversible Door	Yes
FlowSense™ Duct Clogging Indicator	Yes
Wrinkle Care Option	Yes
Child Lock	Yes
Venting Option	4 Way Venting (Electric) 3 Way Venting (Gas)
4 Adjustable Legs	Yes
Remaining Time Display/Status Indicator(s)	Yes
ENERGY	
ENERGY STAR® Qualified	Yes
MATERIALS AND FINISHES	
Aluminized Alloy Steel Drum	Yes
Tub Rear	Painted
Cabinet	Painted Steel
Door / Trim	Solid / White
All Available Colors	White (W)
POWER SOURCE	
Ratings	CSA Listed
Electrical Requirements / Type	Electric: 240V 30 Amps Gas: 120V, 15 Amps
BTU	10,000 Feet

OPTIONS	
LP Conversion Kit	383EEL3002D
Side Venting Kit	383EEL9001B
DIMENSIONS	
Product (WxHxD)	27" x 44 1/4" x 28 15/16" (50 1/4" D with door open)
Carton (WxHxD)	29 1/2" x 48" x 31 1/4"
Weight (Product/Carton) Electric	129.8 / 149.6 lbs.
Weight (Product)	127.7 lbs. (Electric) 131.2 lbs. (Gas)
Weight (Carton)	140 lbs. (Electric) 143.5 lbs. (Gas)
WARRANTY	
Parts & Labor	1 Year
UPC CODES	
WT7100CW	048231023986
DLE7100W	048231023993
DLG7101W	048231024006

# DLE7100W / DLG7101W

## 7.3 cu.ft. Rear Control Top Load Dryer

### QUICK INSTALL & CLEARANCES

For full installation directions/clearances please refer to the corresponding User Manual and Installation Guide.

#### DIMENSIONS/CLEARANCES/WEIGHTS

A Width	27"
B Height	44 1/4"
C Depth	28 15/16"
D Depth with Door Open (in)	50 1/4"
Carton Dimensions (WxHxD)	29 1/2" x 48" x 31 1/4"
<b>ENERGY / RATINGS</b>	
ENERGY STAR® Qualified	Yes
Ratings	CSA Listed
Electrical Requirements / Type	Electric: 240V 30 Amps Gas: 120V, 15 Amps
BTU	10,000 Feet

#### DIMENSIONS AND CLEARANCES

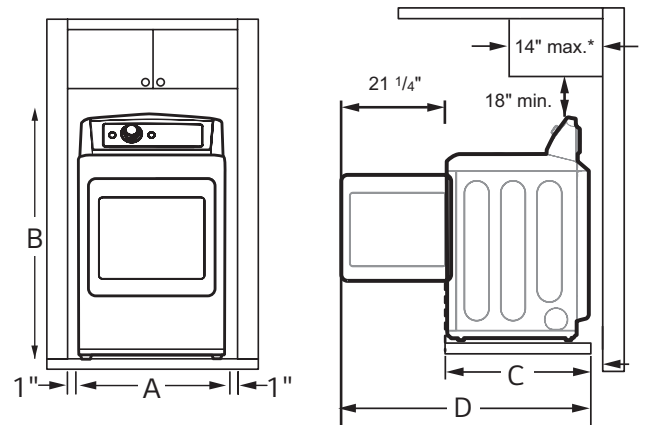

- Install the washing machine on a solid floor that is strong and rigid enough to support the weight of the washing machine, even when fully loaded, without flexing or bouncing. If the floor has too much flex, you may need to reinforce it to make it more rigid. If the floor is not solid, it may cause severe vibration and noise.

#### CONNECTING THE GAS SUPPLY

- Installation and service must be performed by a qualified installer, service agency, or the gas supplier.
- Use only a new stainless steel flexible connector and a new AGA-certified connector.
- A gas shutoff valve must be installed within 6 ft. (1.8 m) of the dryer.
- The dryer is configured for natural gas when shipped from the factory. Make sure that the dryer is equipped with the correct burner nozzle for the type of gas being used (natural gas or propane gas).
- If necessary, the correct nozzle (for the LP nozzle kit, order part number 383EEL3002D) should be installed by a qualified technician and the change should be noted on the dryer.
- All connections must be in accordance with local codes and regulations. Gas dryers MUST exhaust to the outdoors.

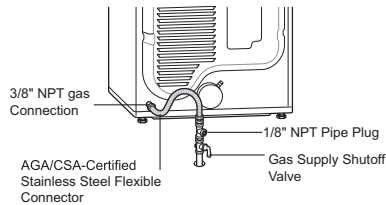

#### VENTING / DUCTWORK

**NOTE:** Follow the guidelines below to maximize drying performance and reduce lint buildup and condensation in the ductwork. Ductwork and fittings are NOT included and must be purchased separately.

- Use 4-inch (10.2 cm) diameter rigid, semi-rigid or flexible metal ductwork.
- The exhaust duct run should be as short as possible.
- Use as few elbow joints as possible.
- The male end of each section of exhaust duct must point away from the dryer.
- Use duct tape on all duct joints.
- Insulate ductwork that runs through unheated areas in order to reduce condensation and lint buildup on duct surfaces.
- Incorrect or inadequate exhaust systems are not covered by the dryer warranty. Dryer failures or service required because of such exhaust systems will not be covered by the dryer warranty.

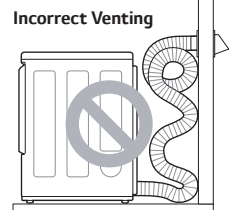
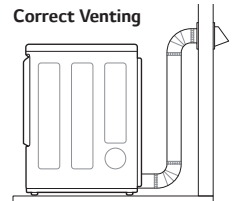



#### CONNECTING ELECTRIC DRYERS

- A **4-wire connection** is required for all mobile and manufactured home installations, as well as all new construction **after January 1, 1996**.
- A **3-wire connection is NOT permitted** on new construction **after January 1, 1996**.
- A UL-listed strain relief is required.
- Use a 30-amp, 240-volt, 4-wire, UL-listed power cord with #10 AWG-minimum copper conductor and closed loop or forked terminals with upturned ends.



- Ductwork is not provided with the dryer. You should obtain the necessary ductwork locally. The vent hood should have hinged dampers to prevent backdraft when the dryer is not in use.
- The total length of flexible metal duct must not exceed 8 ft. (2.4 m).
- Deduct 6 ft. (1.8 m) for each additional elbow. Do not use more than four 90° elbows.

Wall Cap Type	Number of 90° Elbows	Maximum length of 4-inch diameter rigid metal duct	
 Recommended	0	65 ft.(19.8 m)	
	1	55 ft.(16.8 m)	
	2	47 ft.(14.3 m)	
	3	36 ft.(11.0 m)	
 a: 4" (10.2 cm)	4	28 ft.(8.5 m)	
	 Use only for short run installations	0	55 ft.(16.8 m)
		1	47 ft.(14.3 m)
		2	41 ft.(12.5 m)
3		30 ft.(9.1 m)	
b: 2.5" (6.35 cm)	4	22 ft.(6.7 m)	