

CARE AND MAINTENANCE

Spot clean using a mild water-free solvent. Only a professional cleaner should undertake a complete overall cleaning.

The use of steam or water-based cleaners may cause excessive shrinking or staining.

















NOTICE

* Please make sure that you have all parts indicated before you begin assembly of this item

* This item should be assembled on a soft surface to prevent scratching the finish during assembly

* This item may require periodic tightening

Part List and Hardware List

PIECE	DESCRIPTION	PICTURE	QUANTITY
1	Sofa&Chair side 1		3X
2	Sofa&Chair side 2		3X
3	Chair Bottom		2X
4	Chair Back		2X
5	Sofa Bottom		1X
6	Sofa Back		1X
7	Table Top		1X
8	Table Foot		2X
9	Seat Cushion		4X
10	Back Cushion		4X
A	Allen bolt(M6x30 mm)		18X
B	Flat washer		46X
C	Allen bolt(M6x20 mm)		20X
D	Hexagon nut		8X
E	Allen key		1X
F	Open end wrench		1X

 **SAFAVIEH**
O U T D O O R

Model# PAT2516

Product Dimensions:

50.4" x 26" x 25.6" H (Chair)

28.3" x 26" x 25.6" H (Sofa)

39.4" x 19.7" x 14" H (Table)

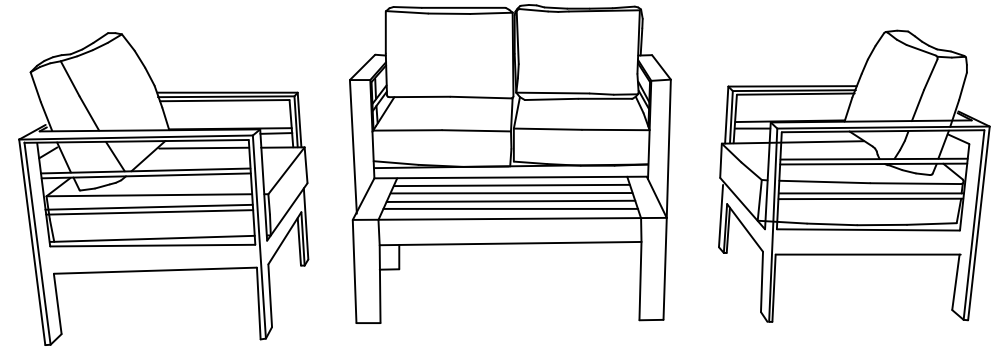

 **WARNING** 

Weight Capacity:275lbs(single seat)

550lbs(twoperson seat)

WARNING:DO NOT STAND ON CHAIR

PREPARATION

Before beginning assembly of product, make sure all parts are present. Compare parts with package contents list and hardware contents list.

If any part is missing or damaged, do not attempt to assemble the product.

Estimated Assembly Time: 45 minutes.

Tools Required for Assembly (included): Allen Key and Open end wrench

1

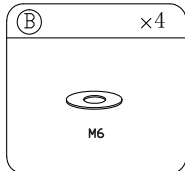
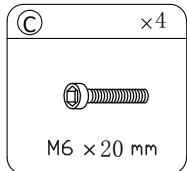
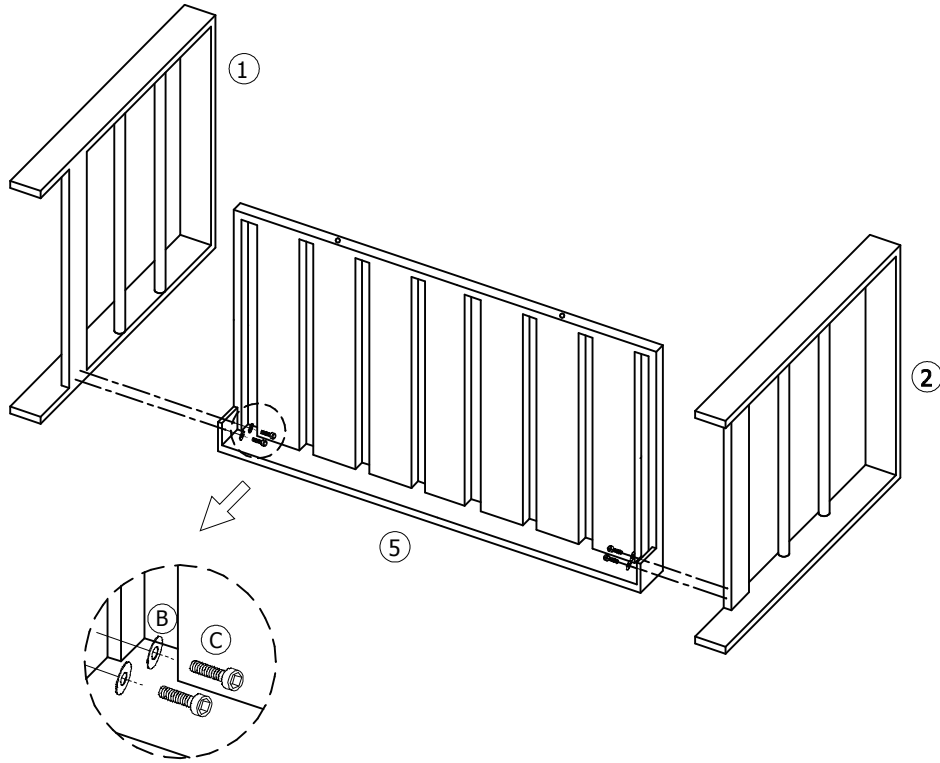

2

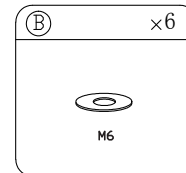
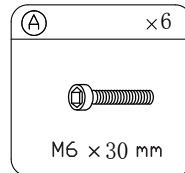
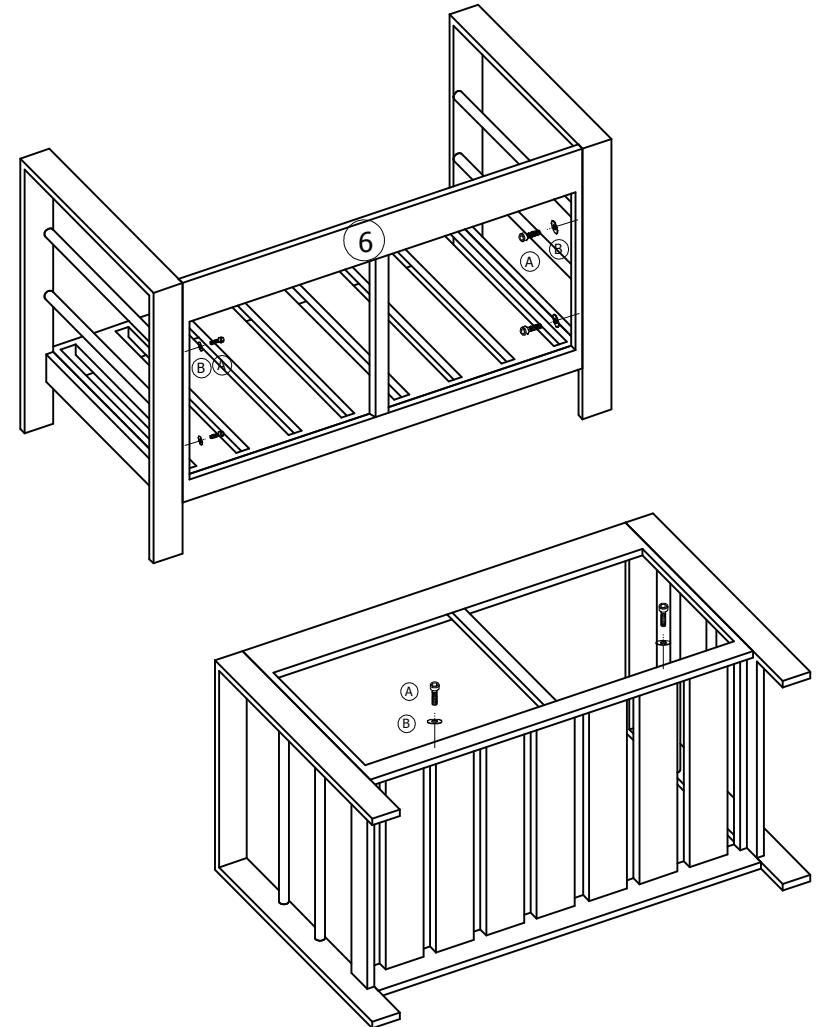

3 x2

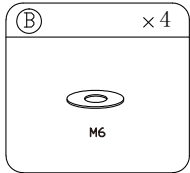
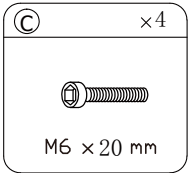
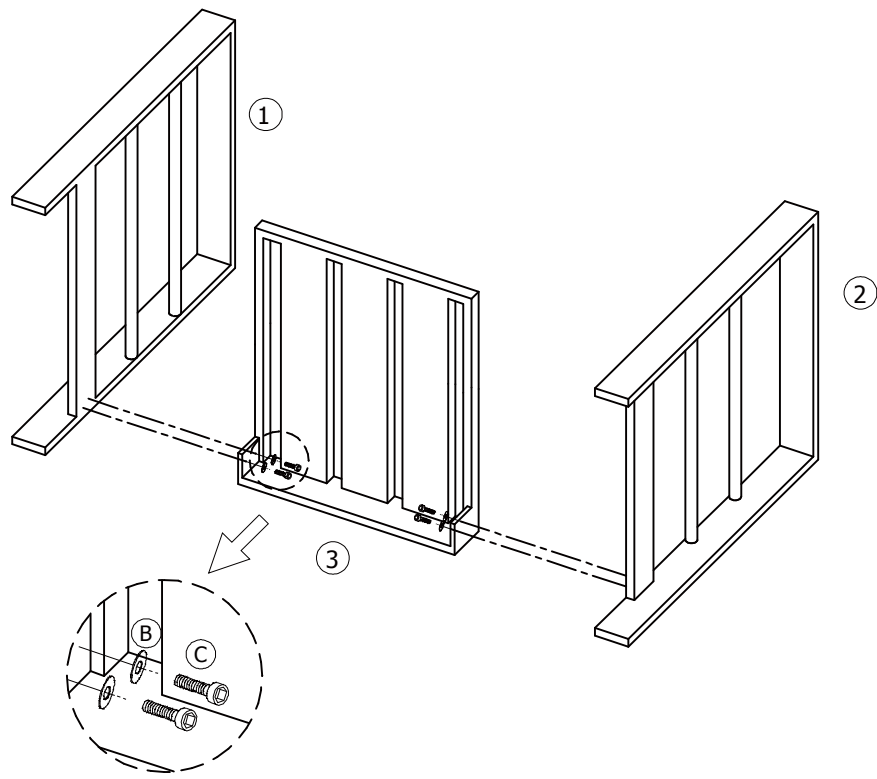

4 x2

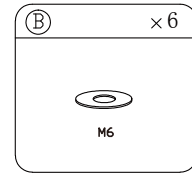
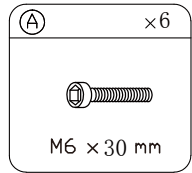
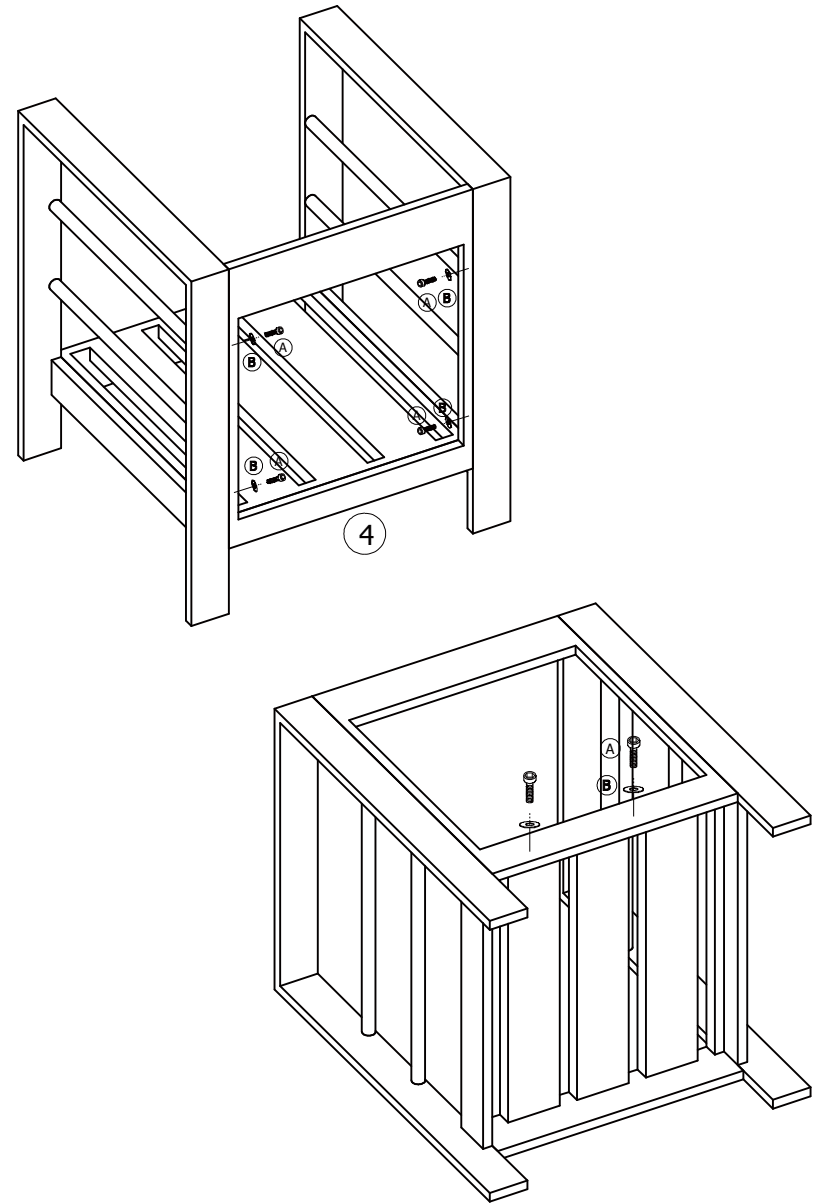

5

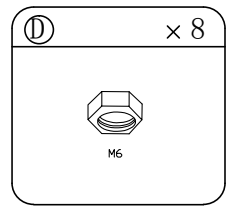
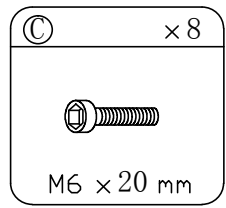
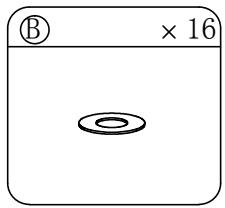
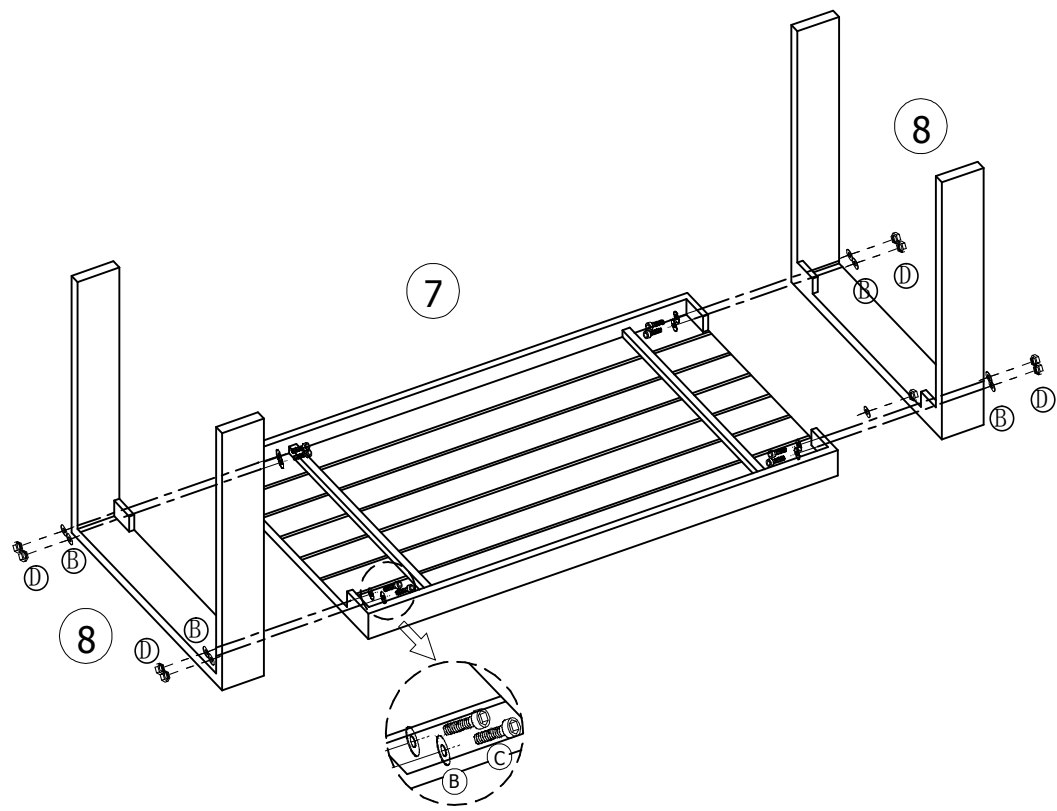

6

