



Friends

42688



2

3

4

5

6



1

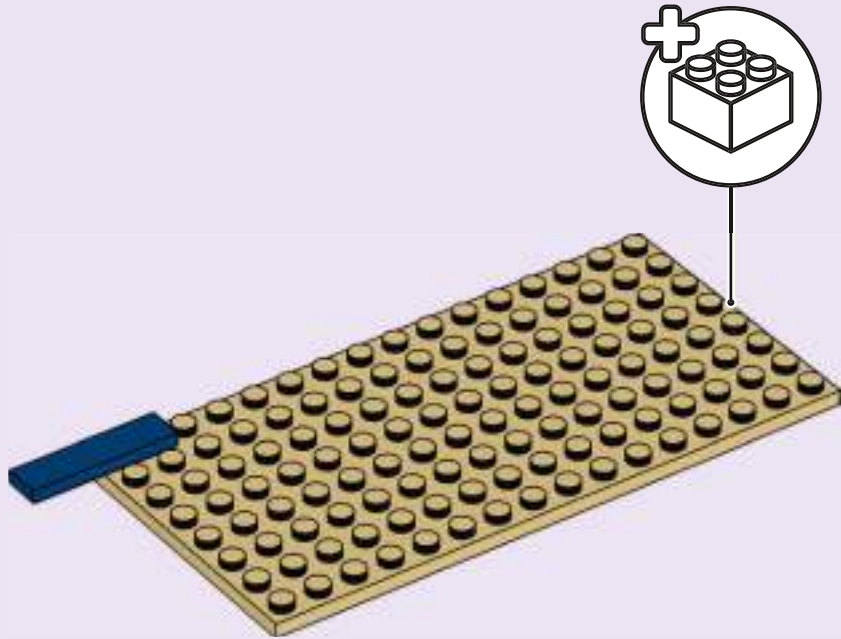

2

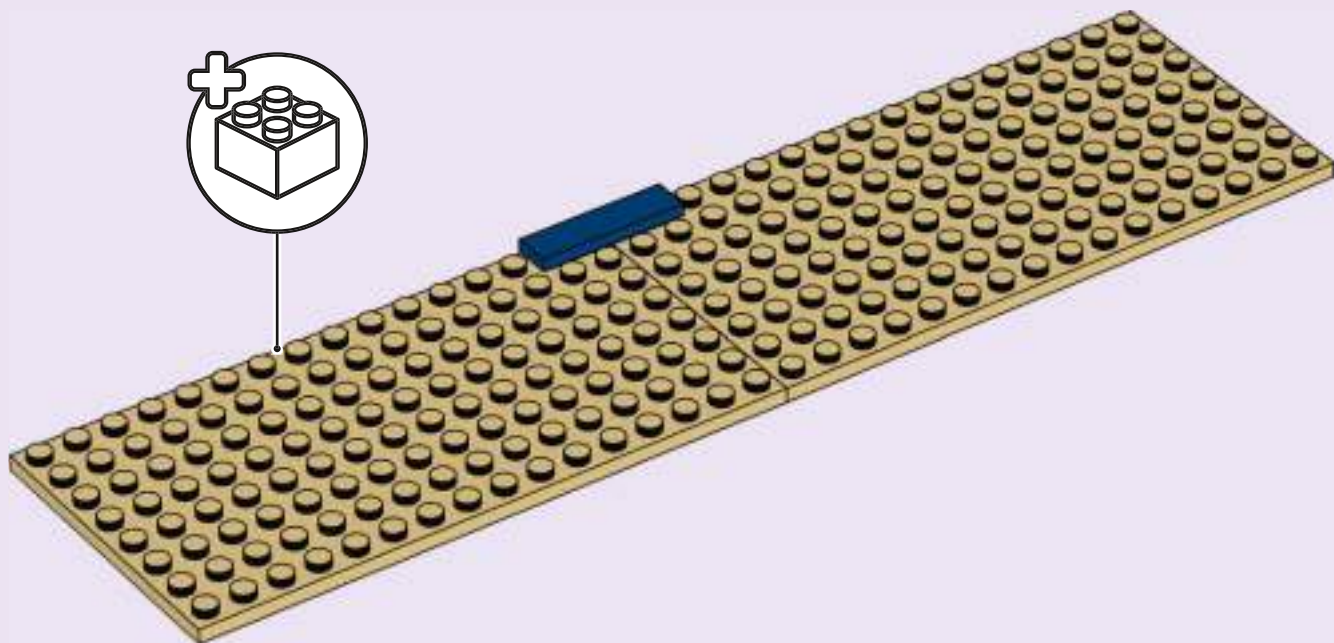



3

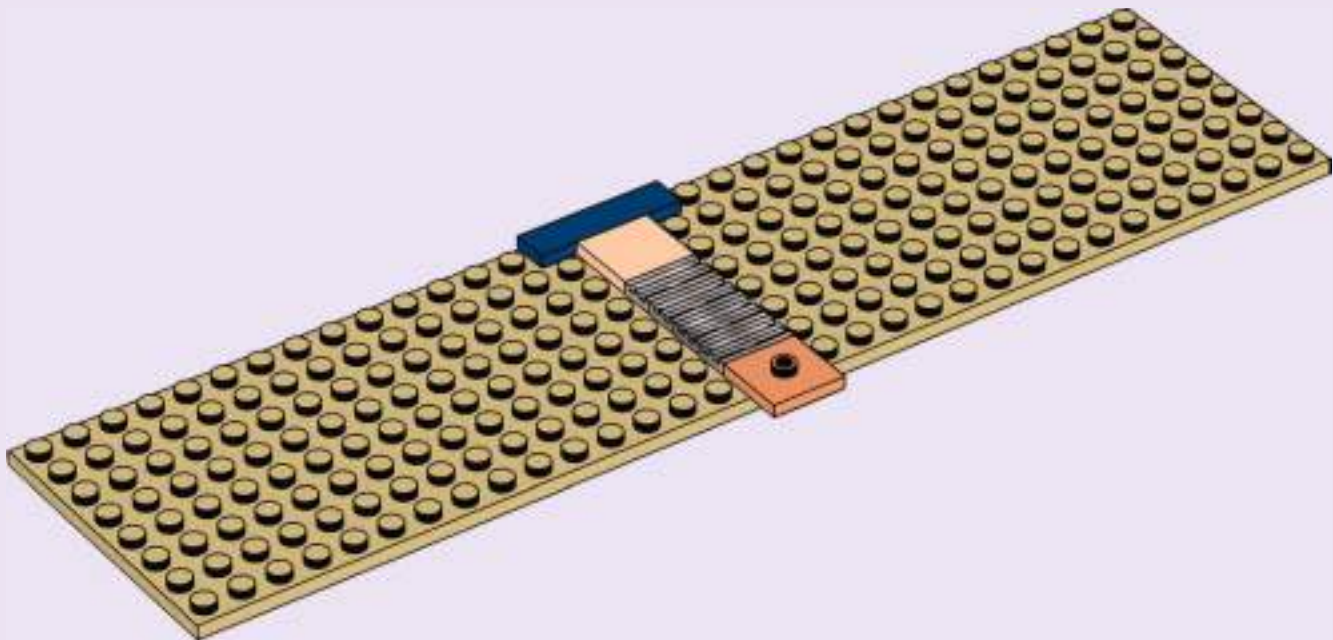

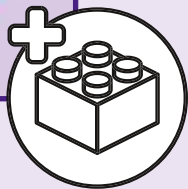
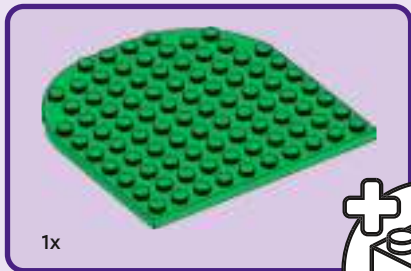

4

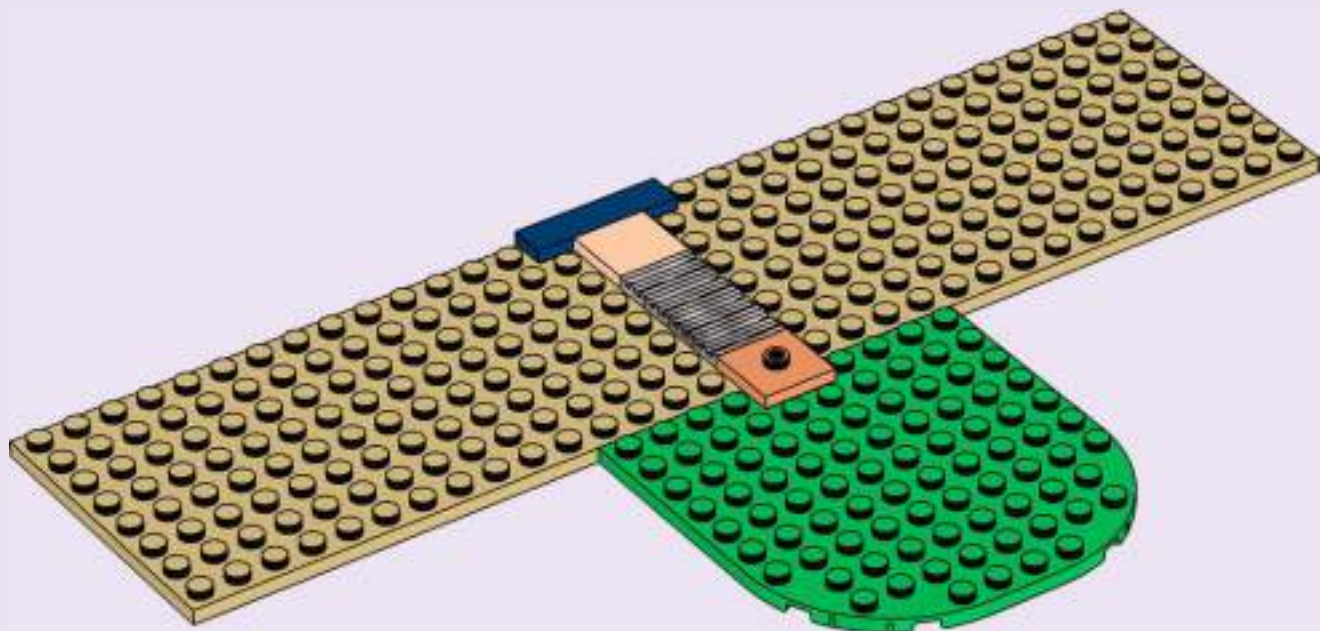



5

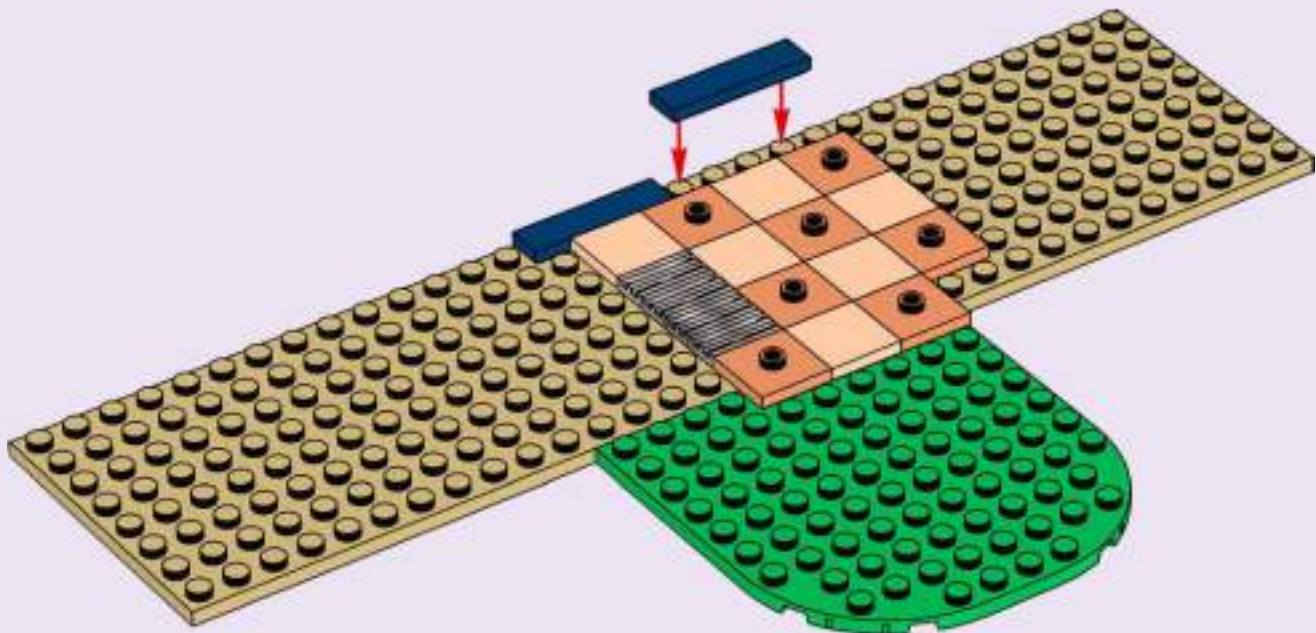



6

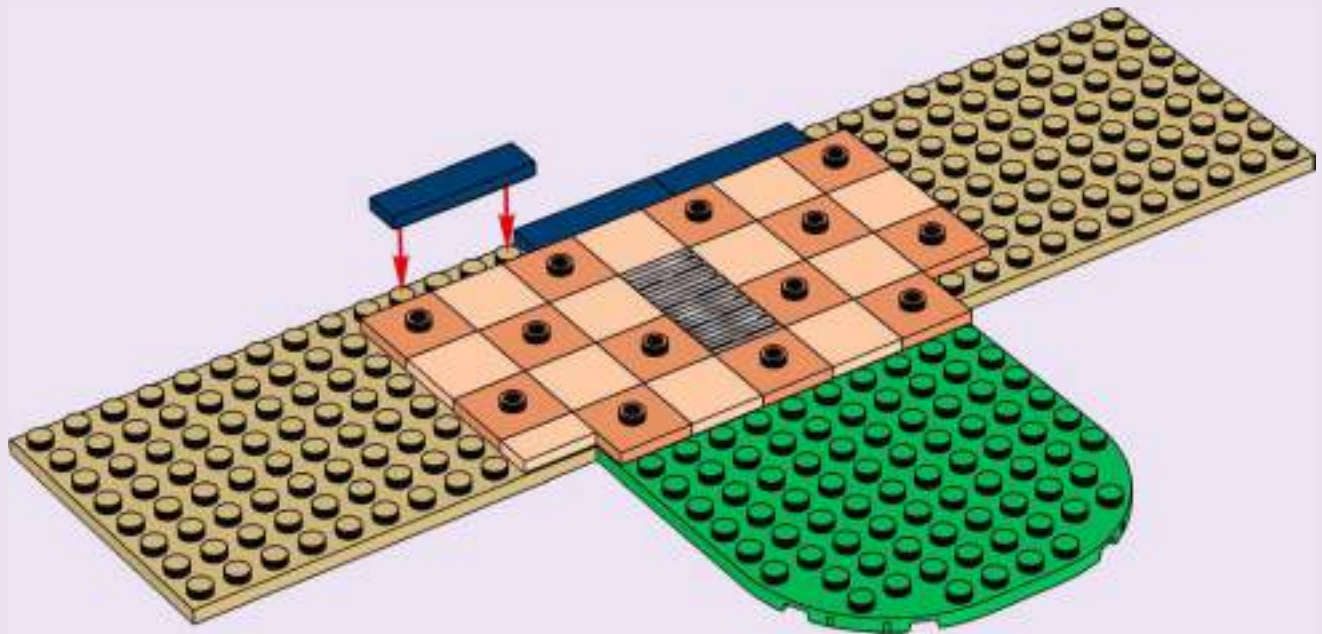



3x



2x

7

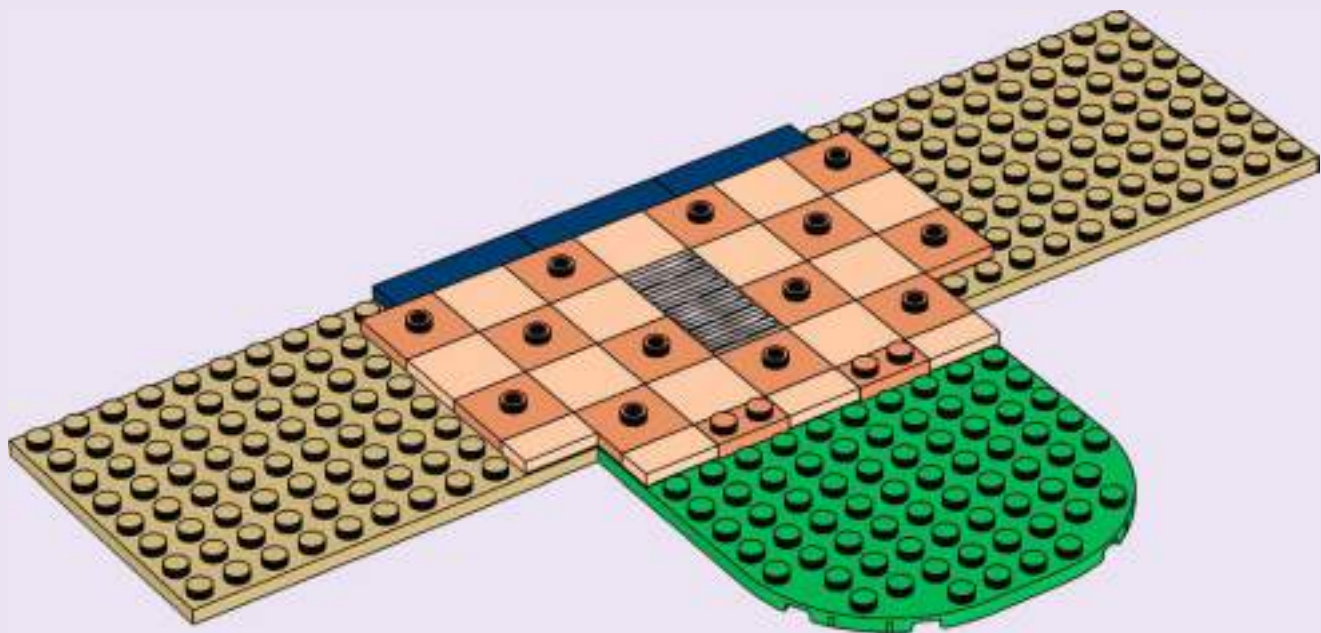



8

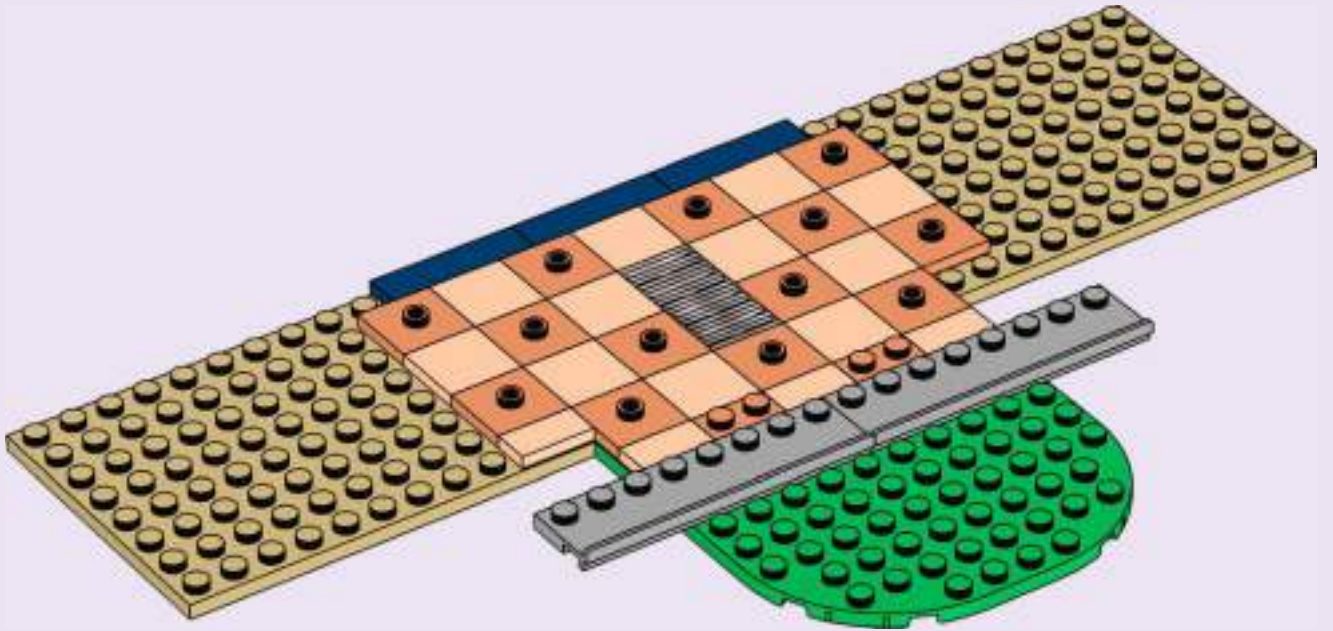



9

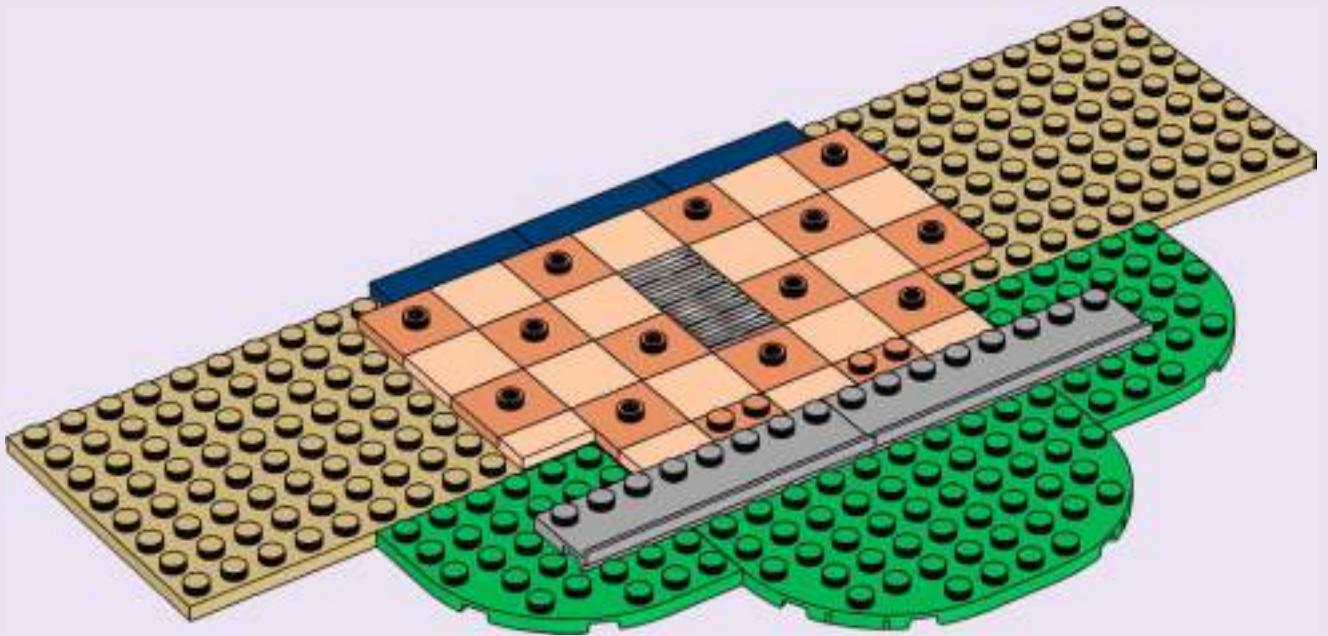



10

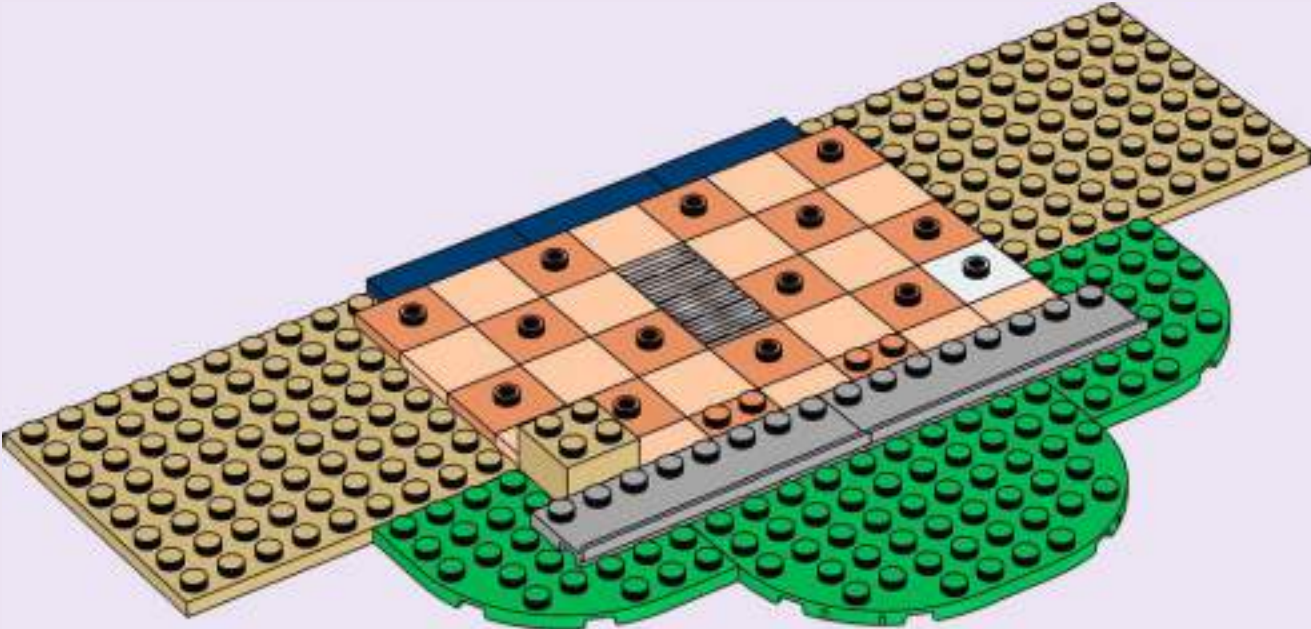



11

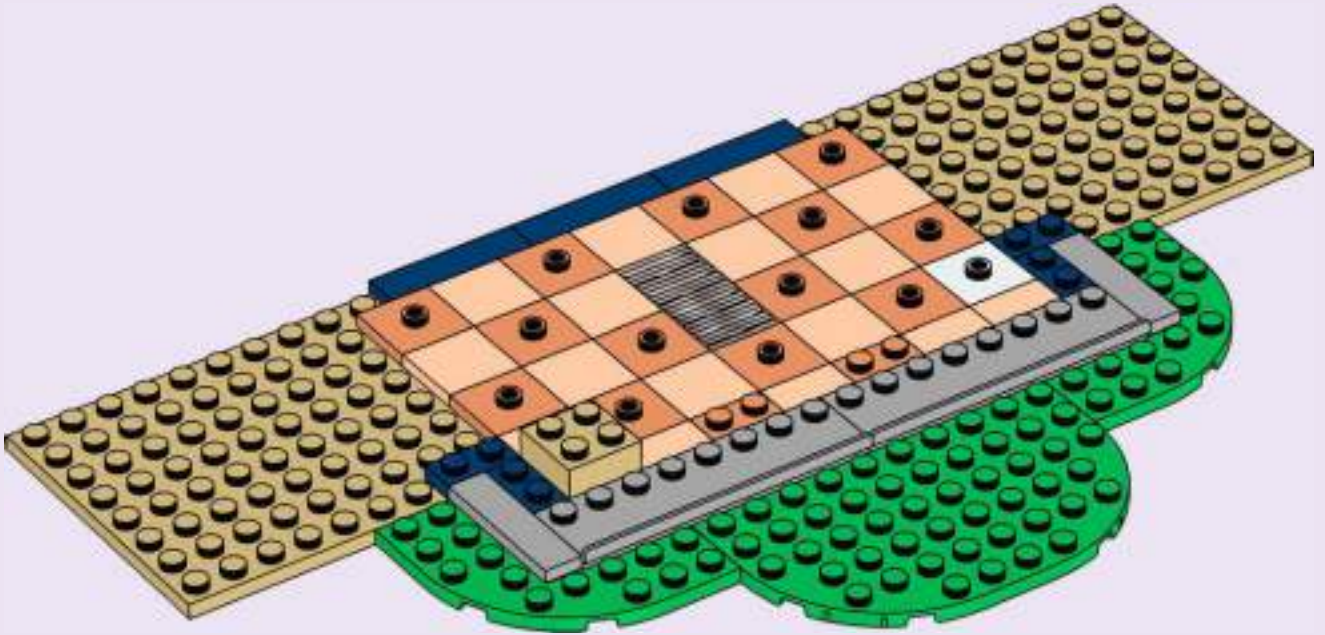



1x



2x

12

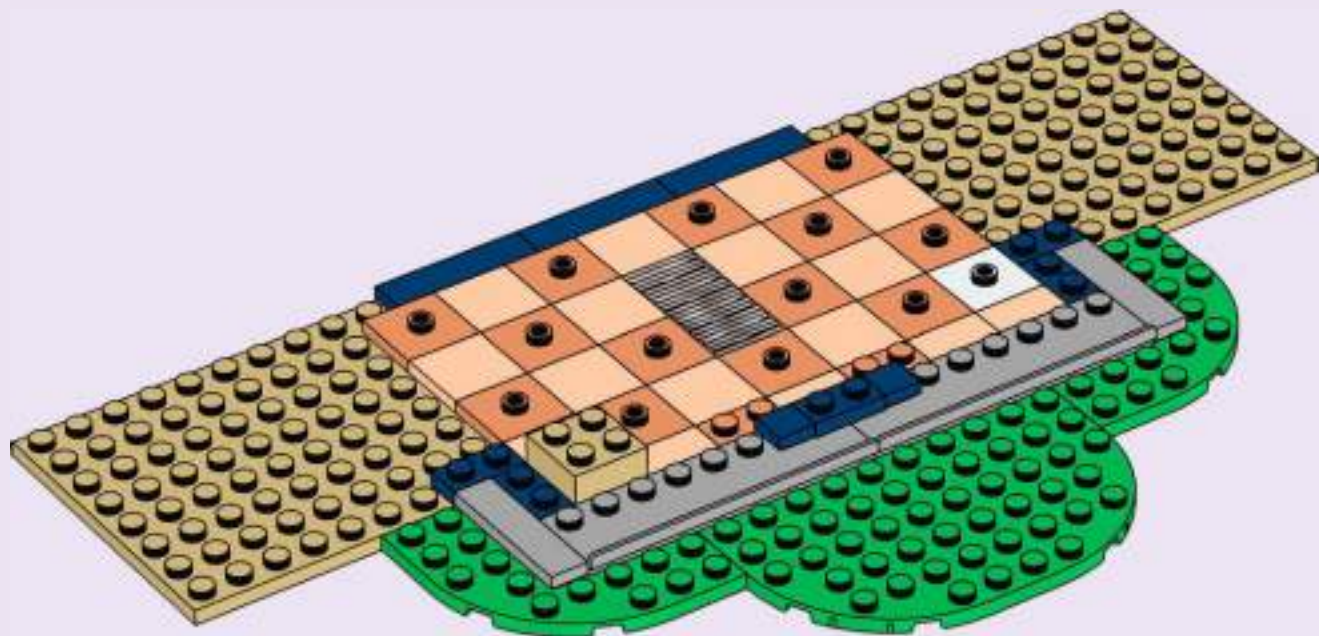



13

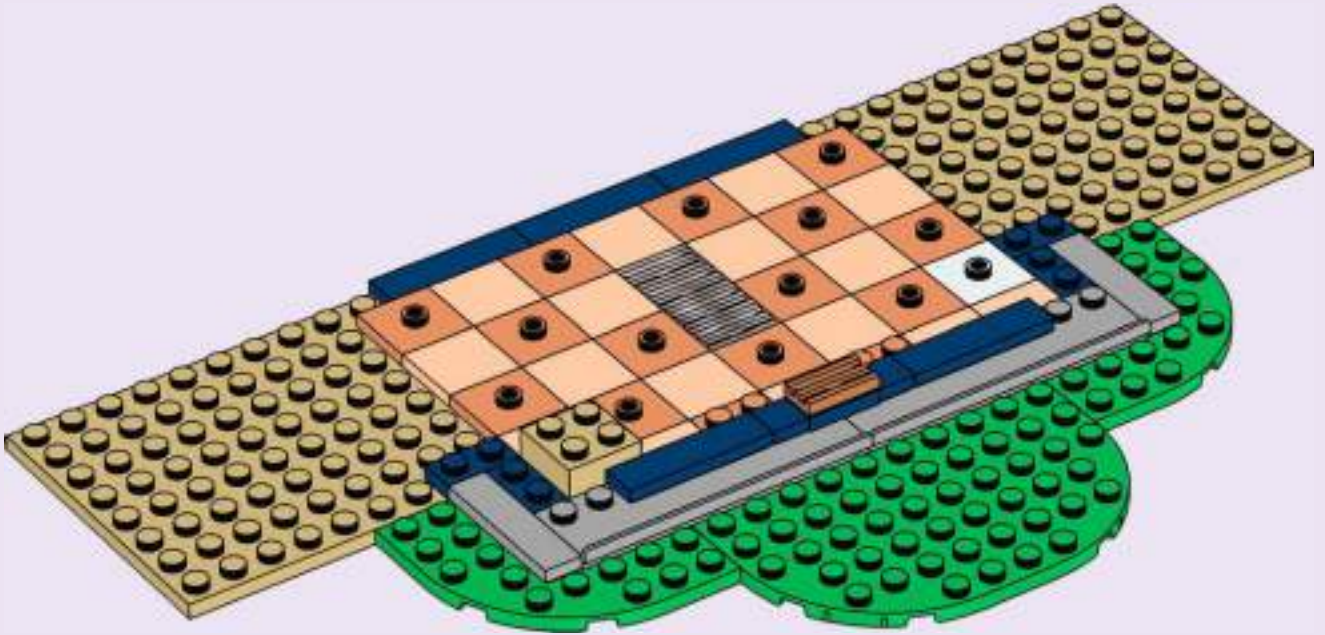



4x

14

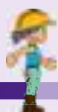
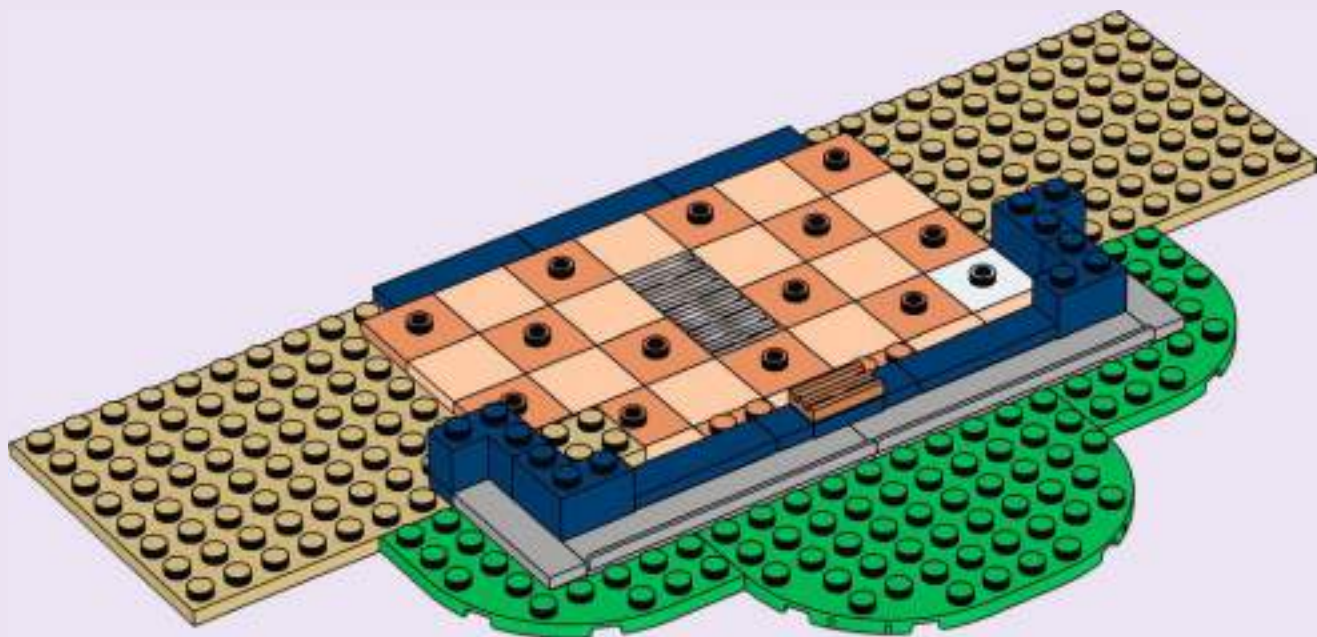



2x

15

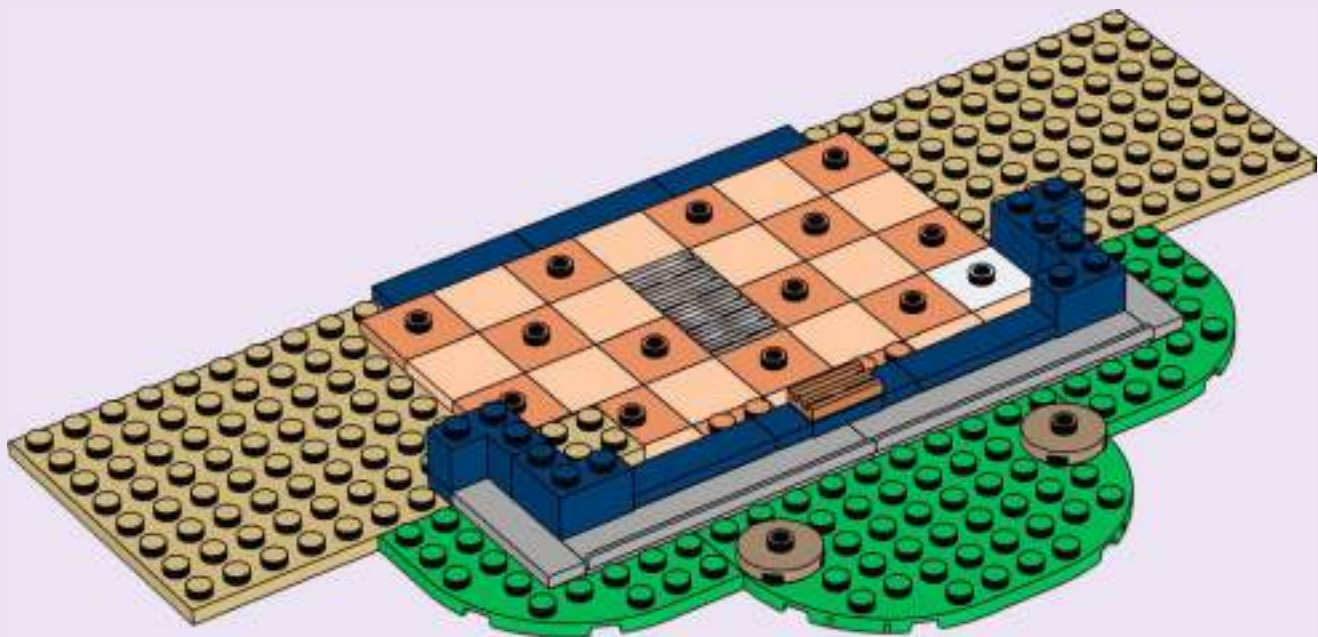



4x



8x

16

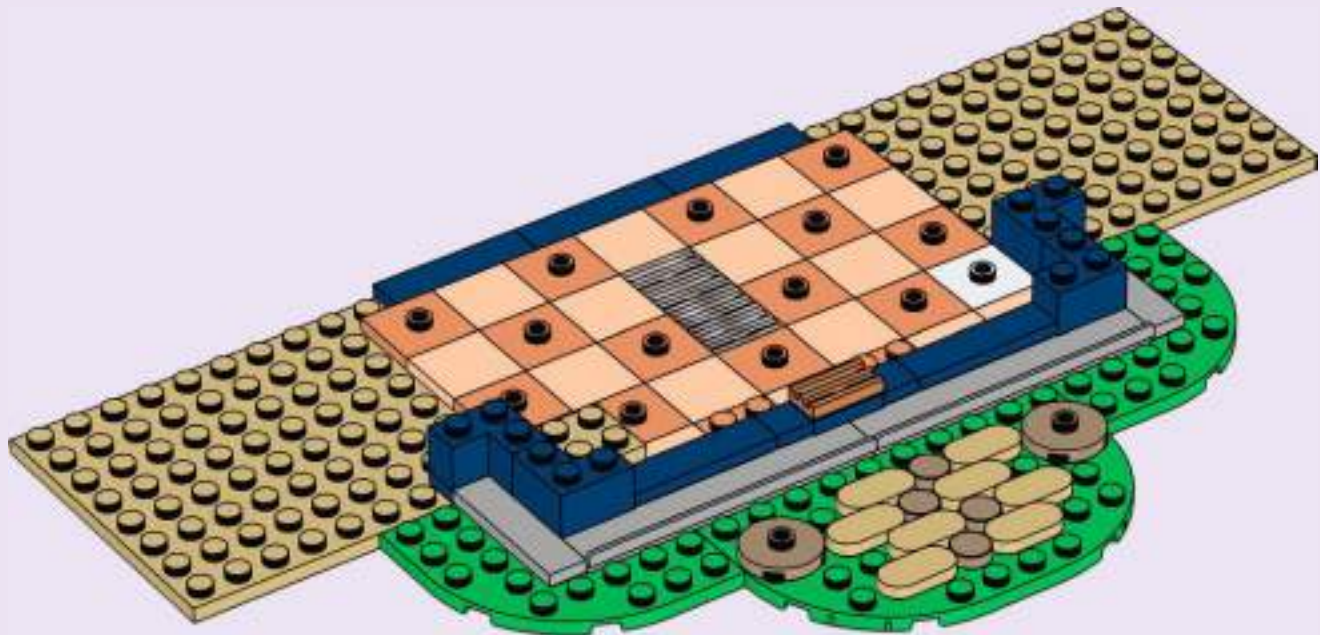

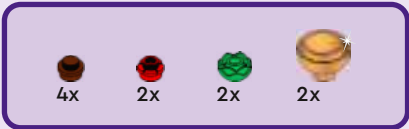

17

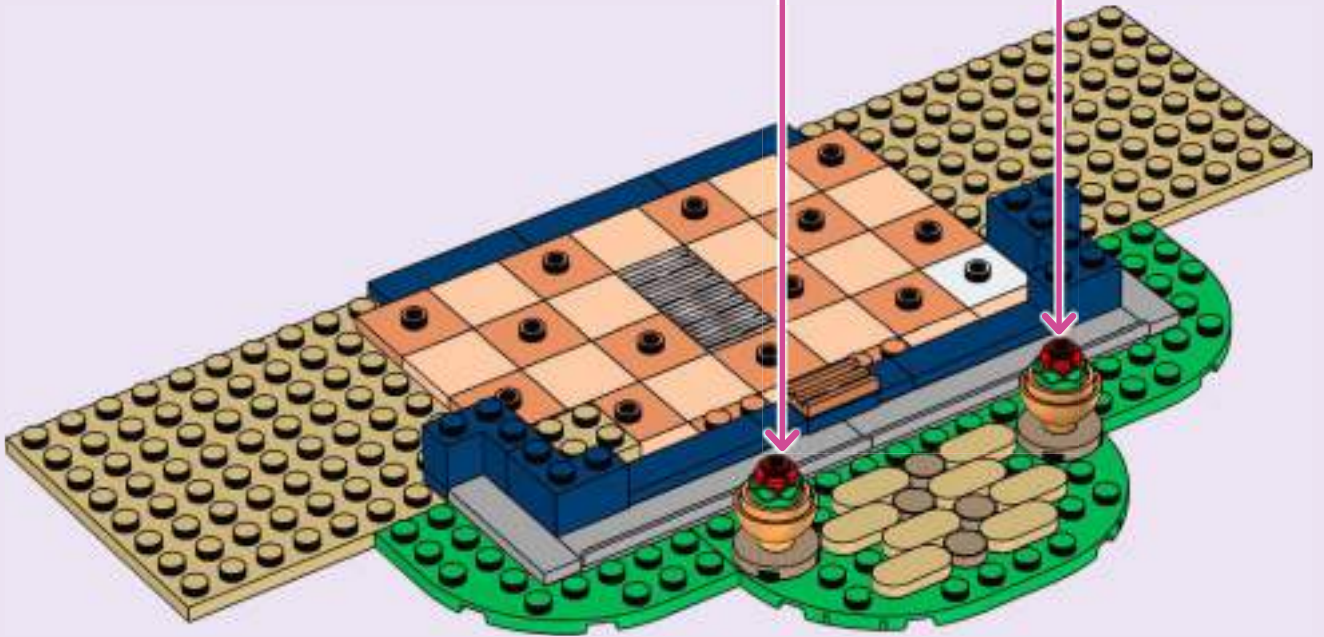



18

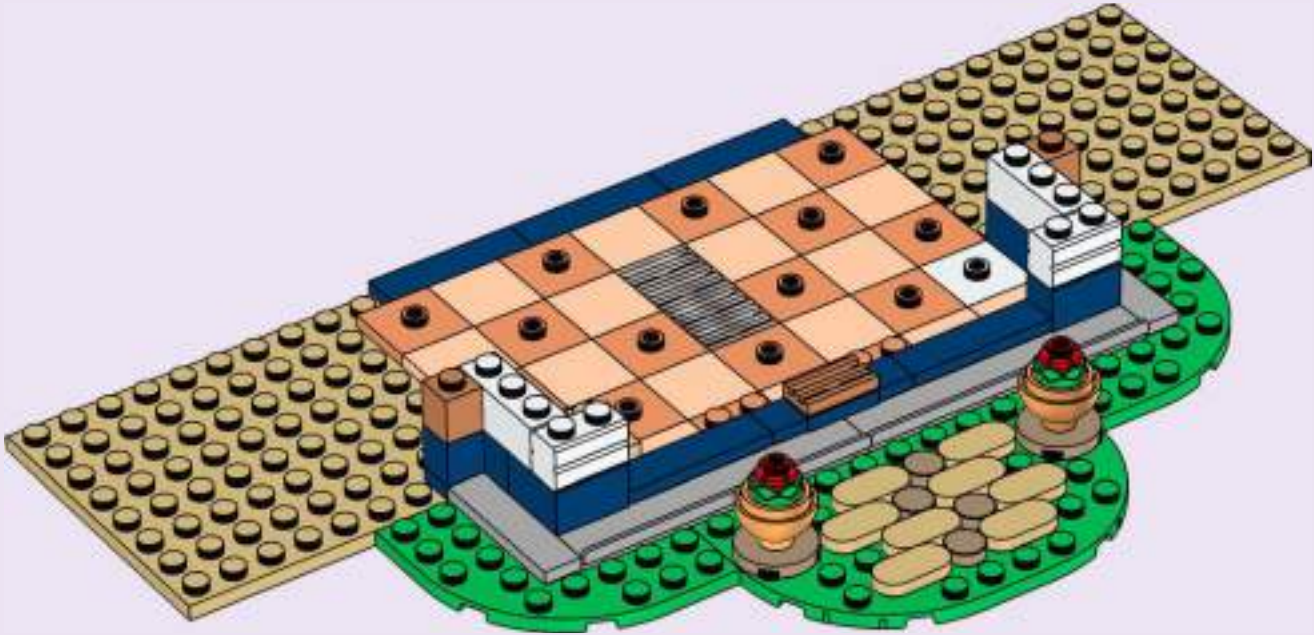

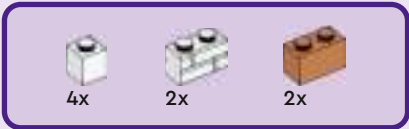

19

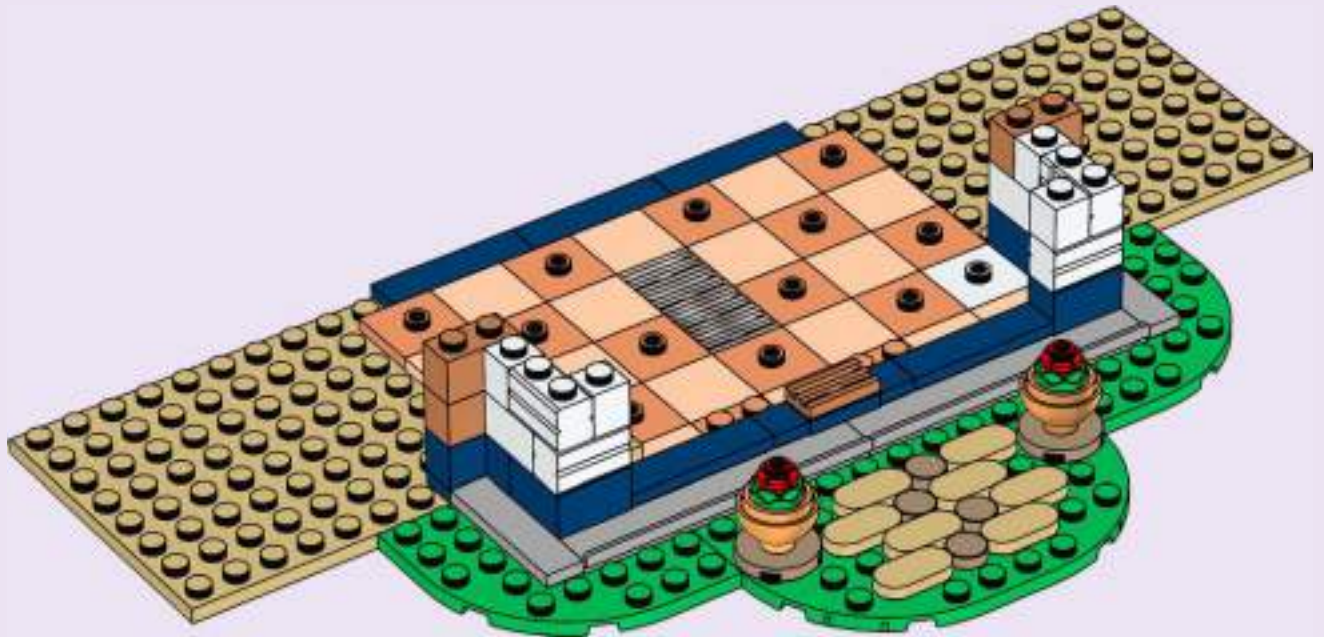



20

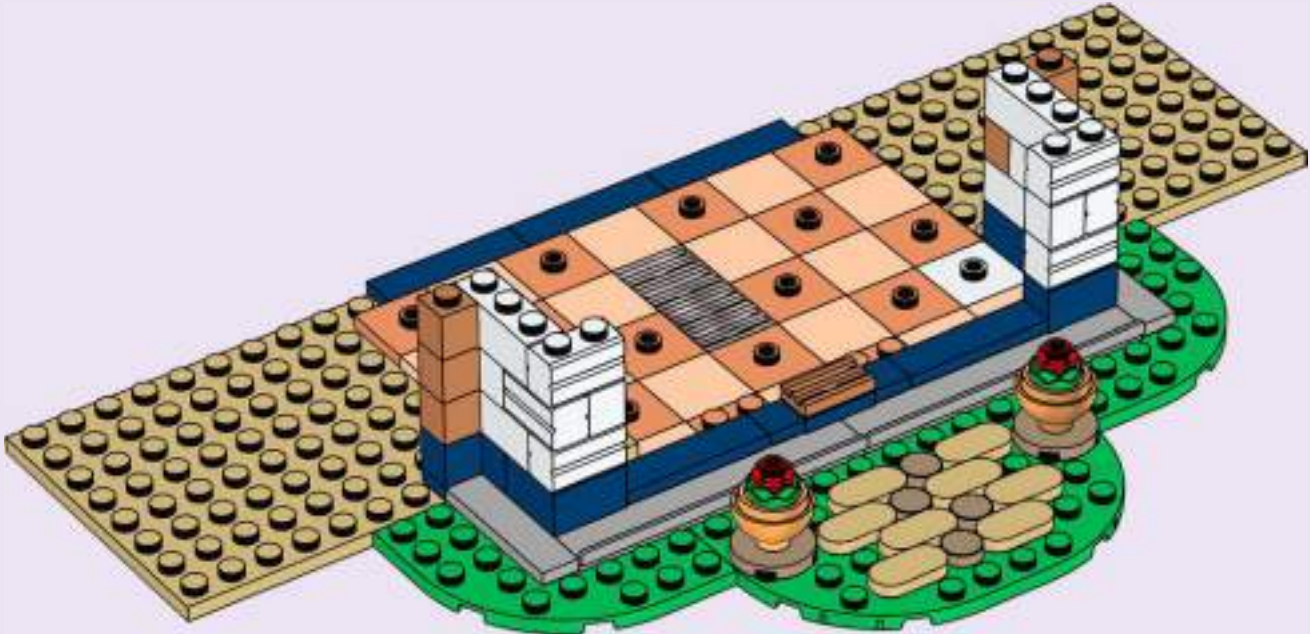



4x



2x



2x

21

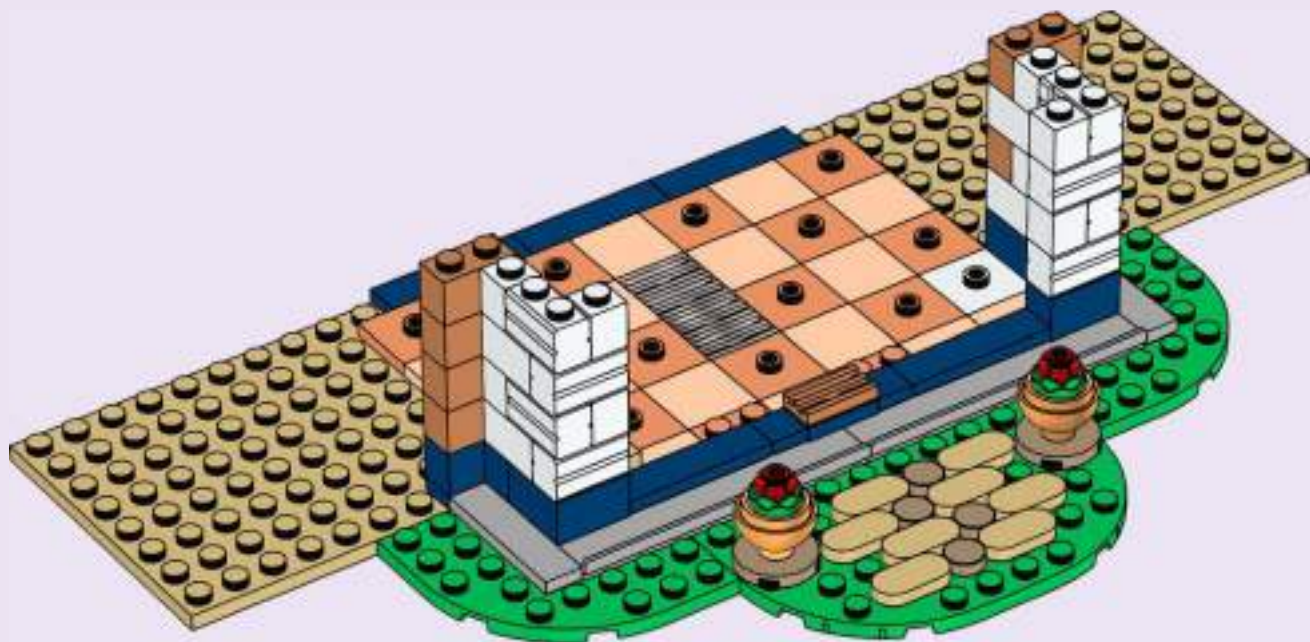



4x

22



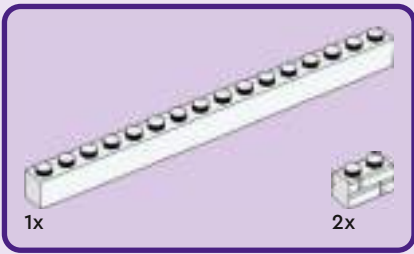

23

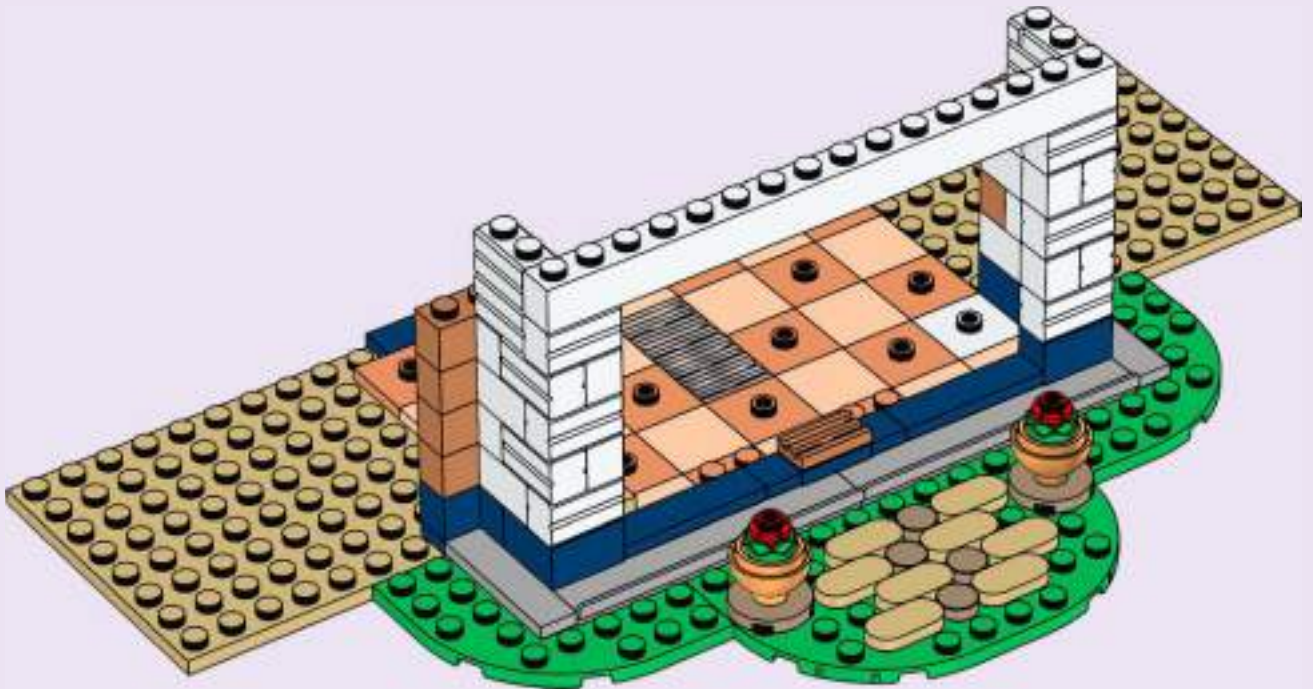



Cindy



1



2

Thunder

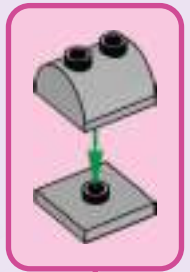

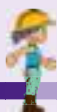
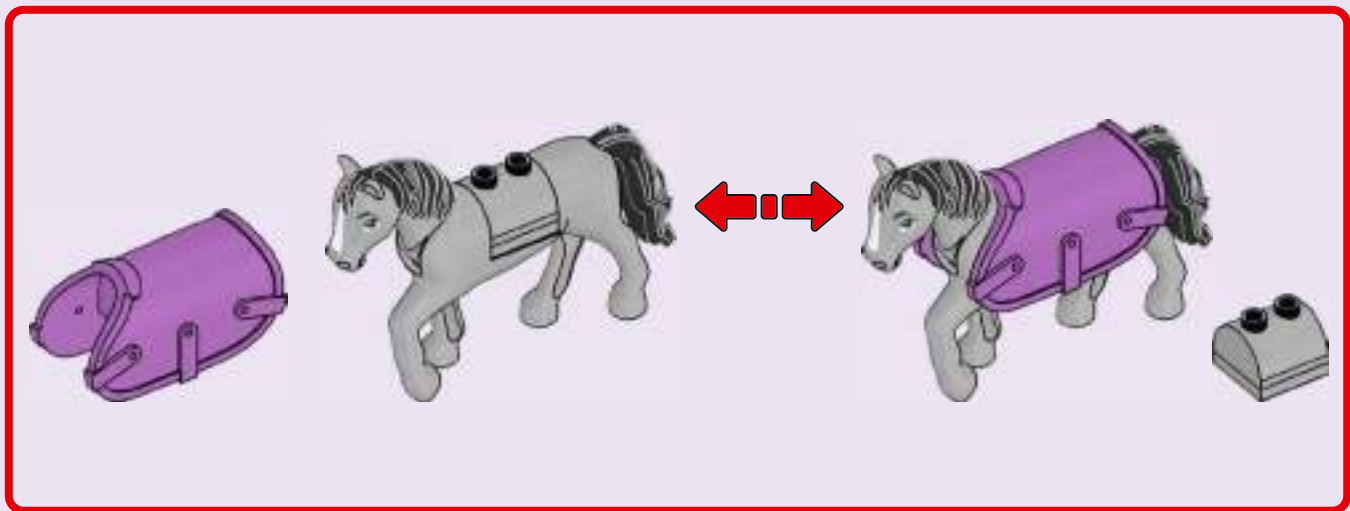

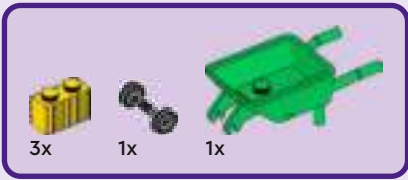

1



2



3





24

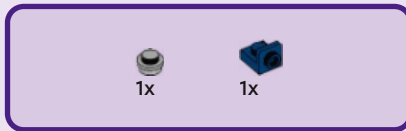
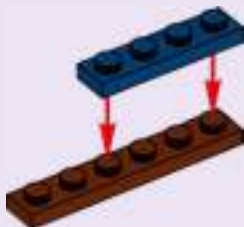

25

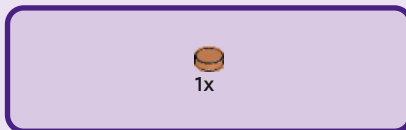

26



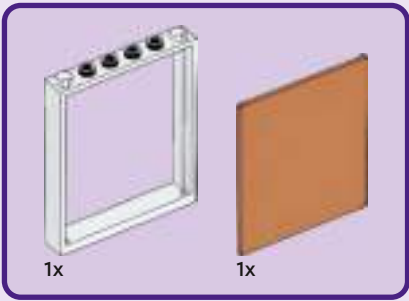

27

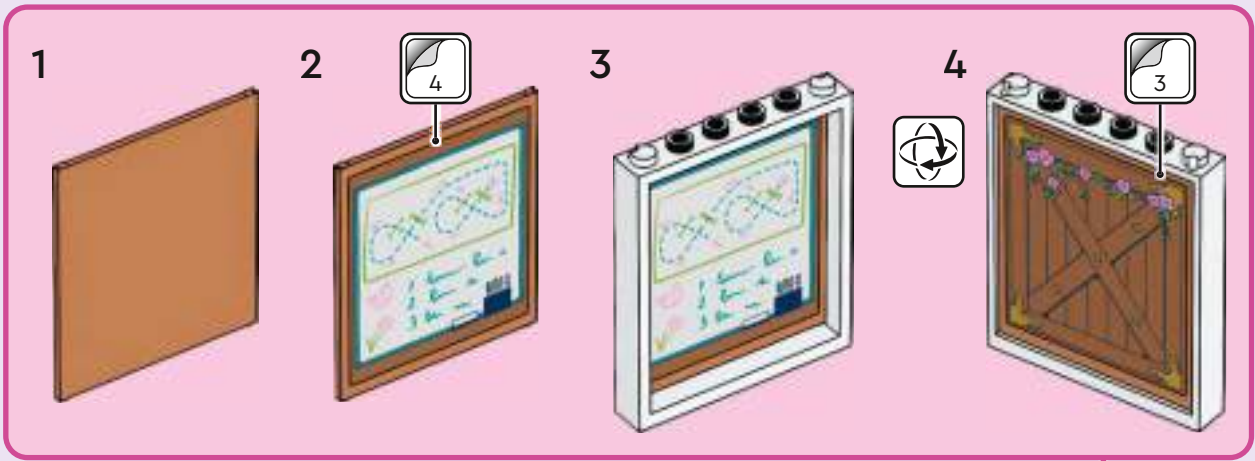



1x

28



29

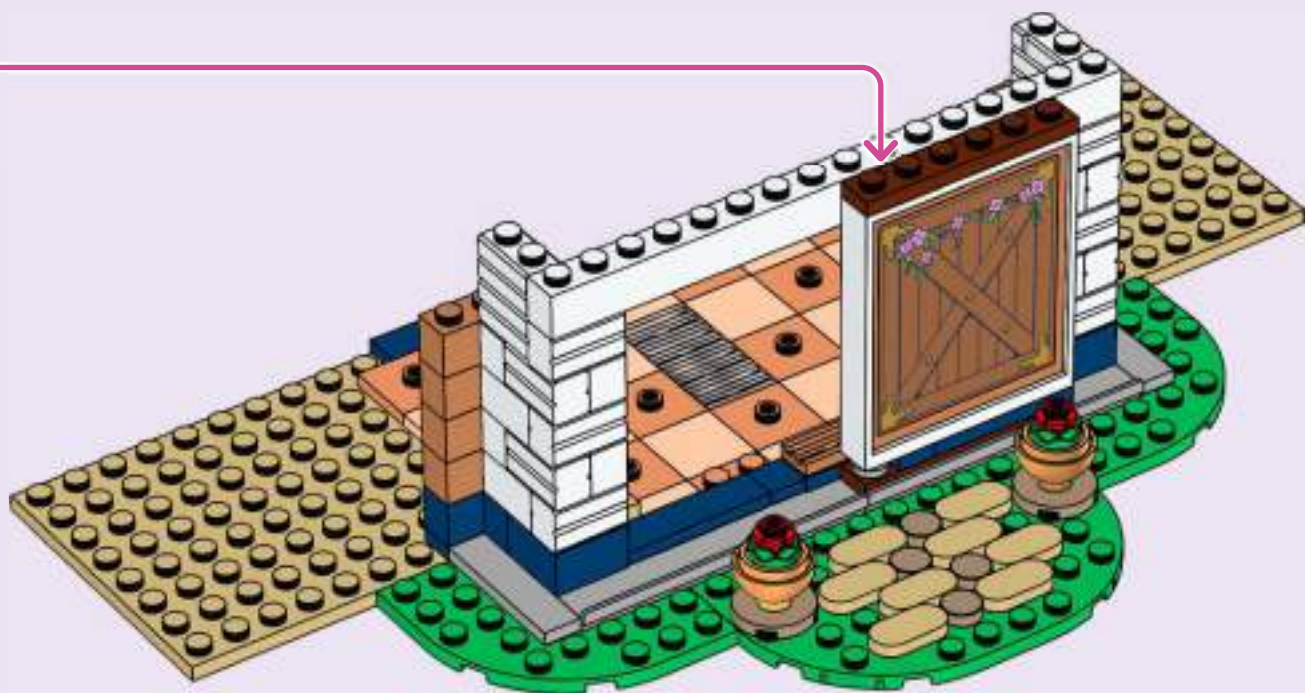



30

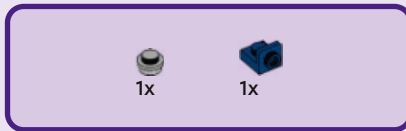
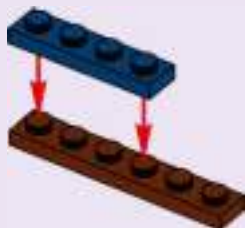

31

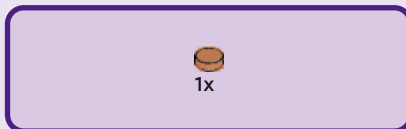

32





1x

34



35

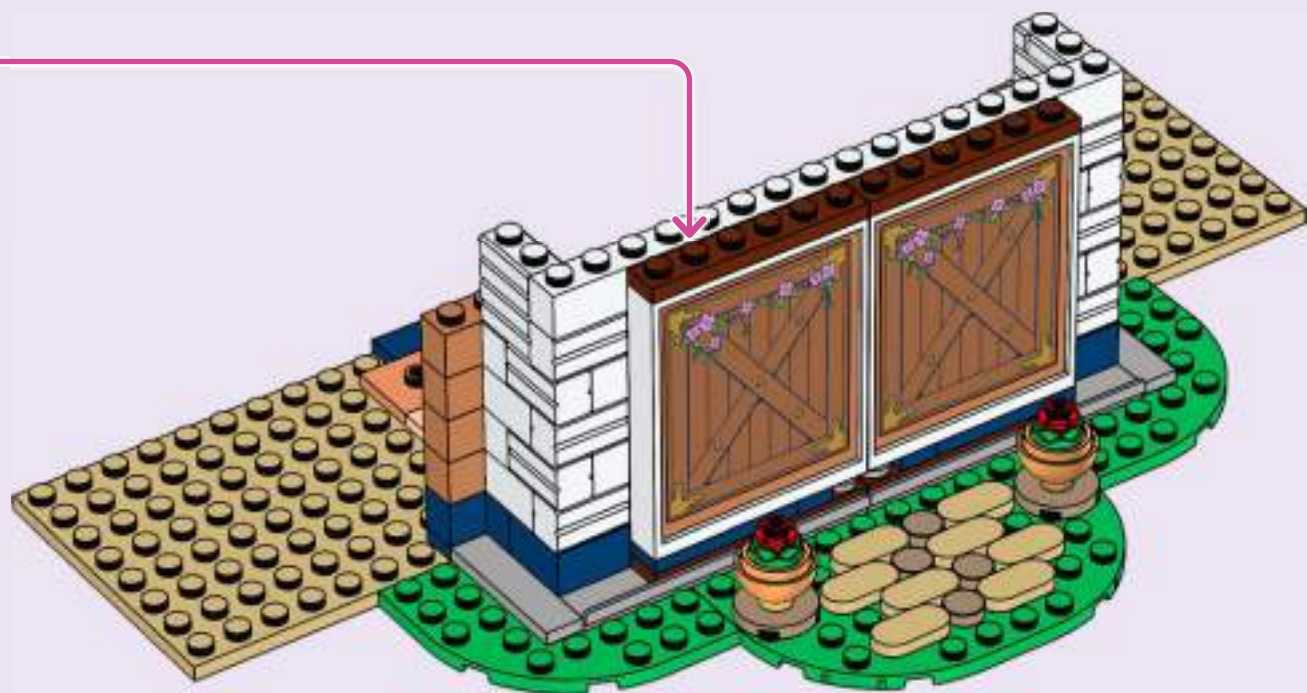



36





4x



4x

37





4x

38

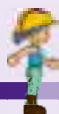



2x

39



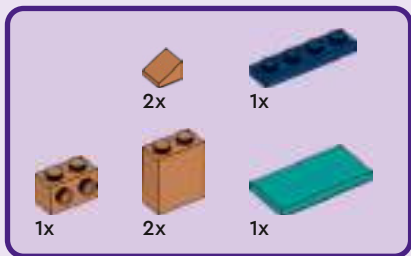

40

1

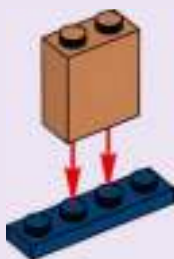

2



3

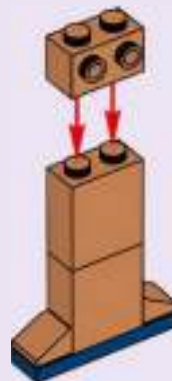

4

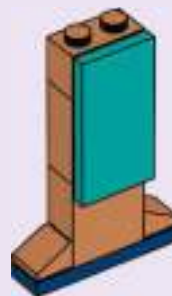

5

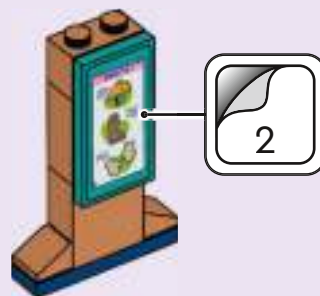

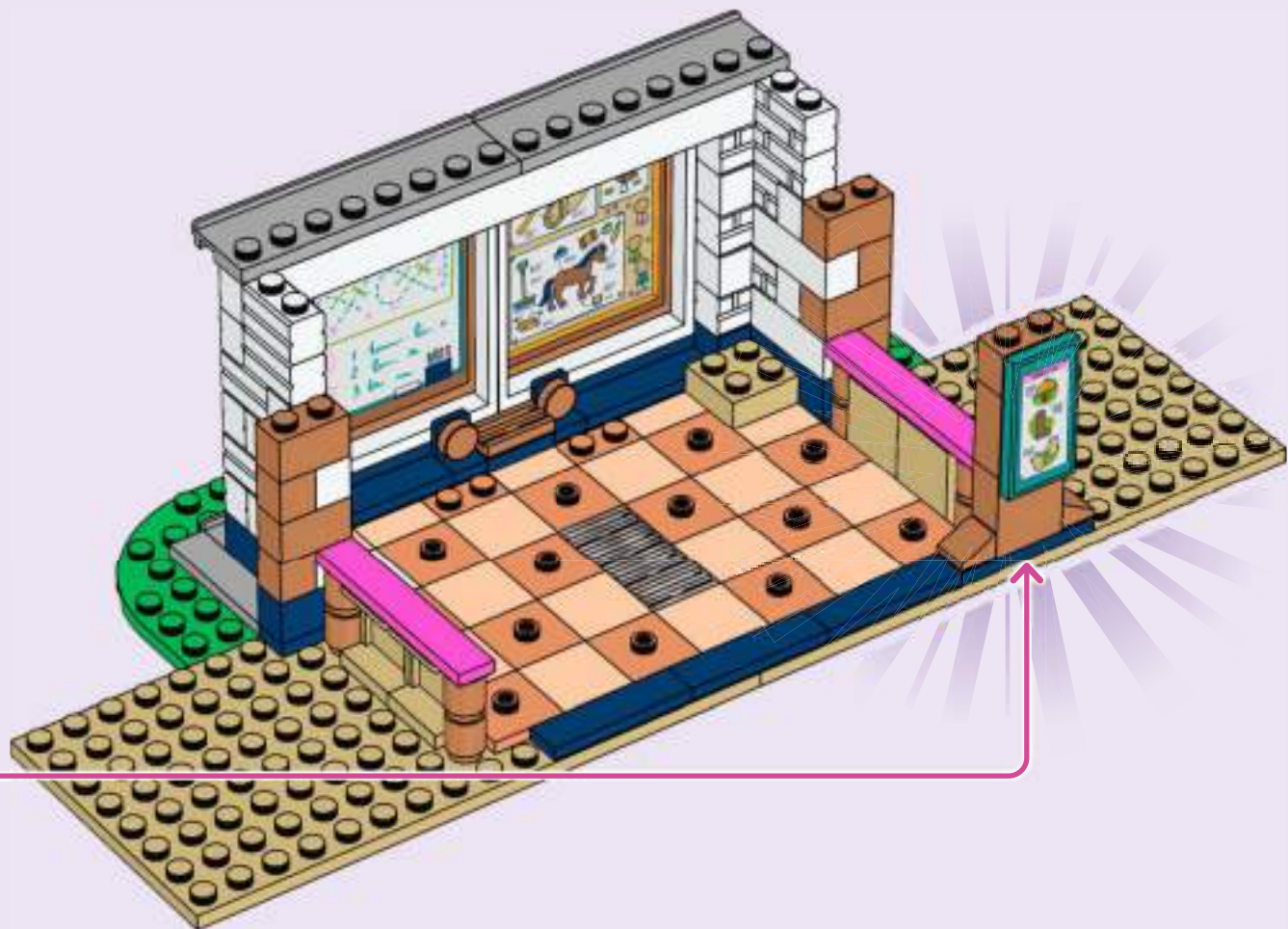



45

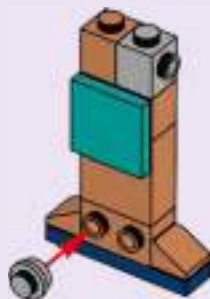

46

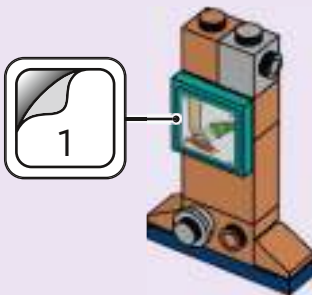

47

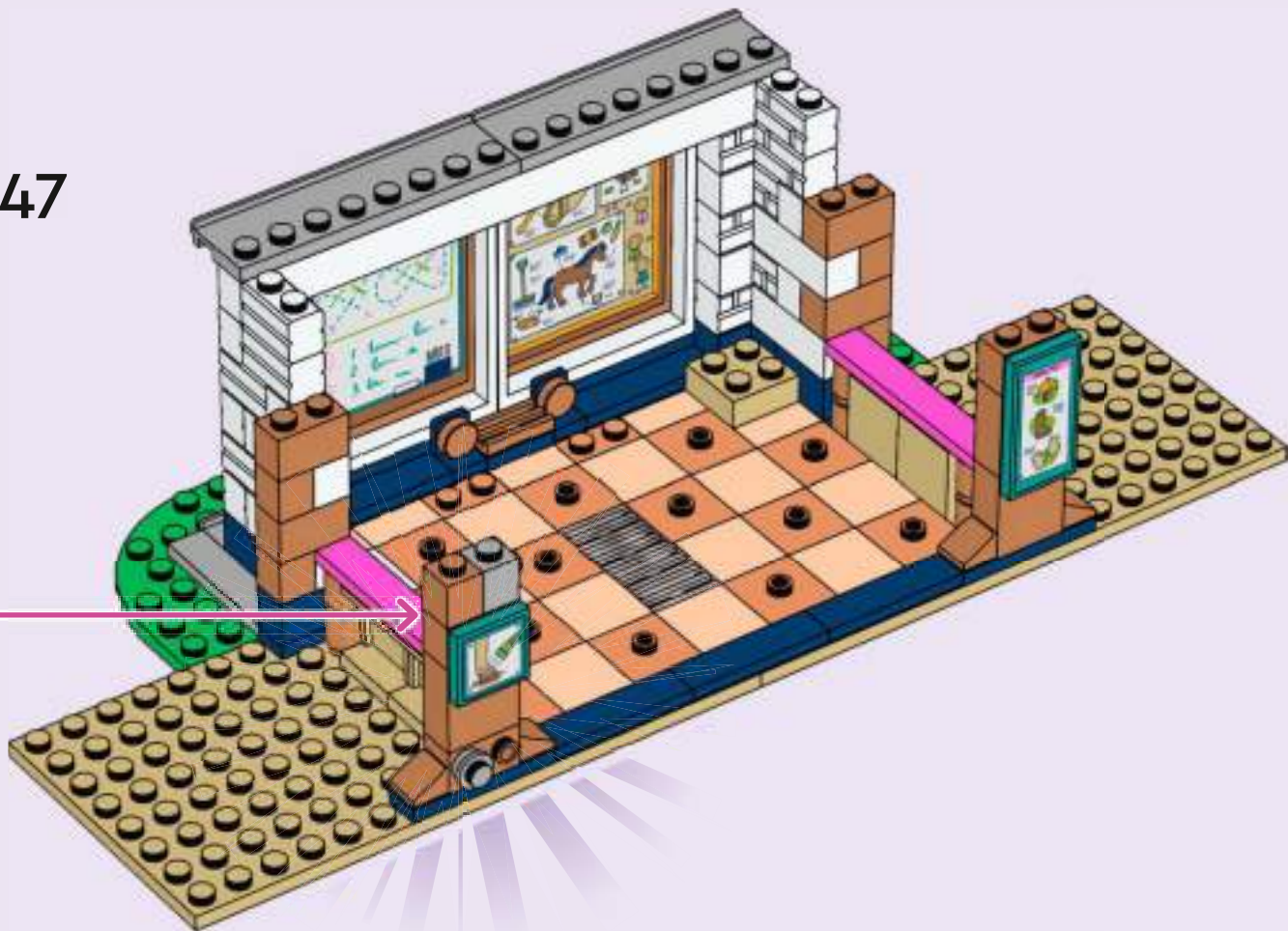

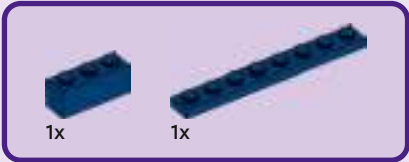

48

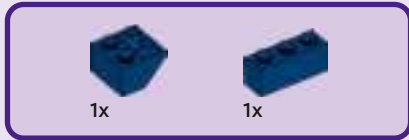
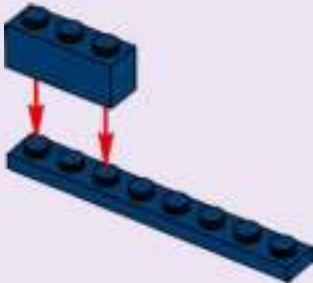

49

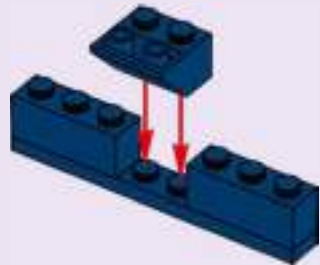



2x

50

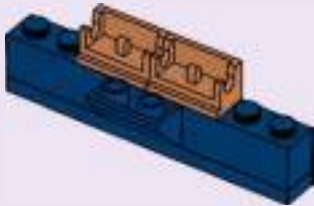

1x

51

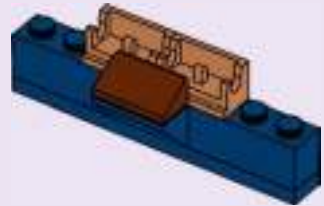



2x

52

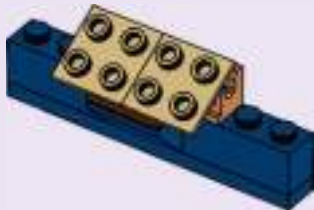

2x

53

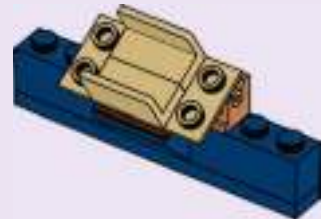



2x

54

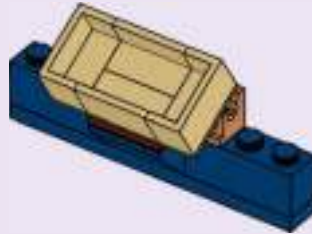

2x



55



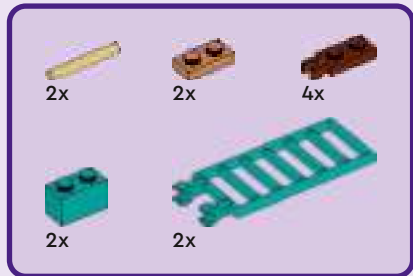

56

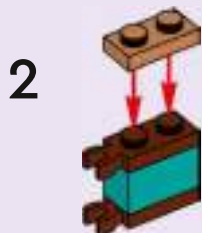
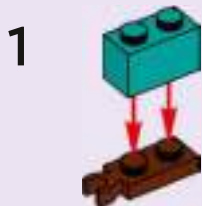

3



4

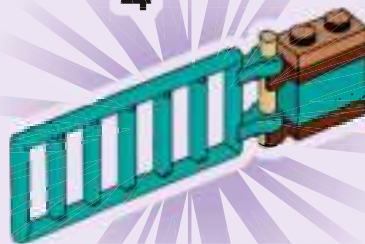

2x







2x

57





4x

58



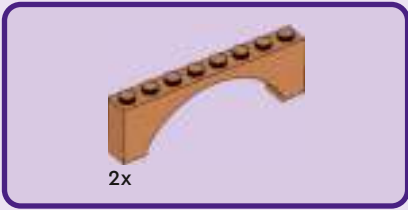

59



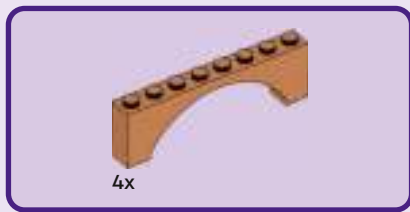

60



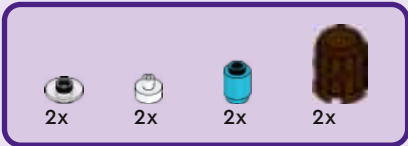

61



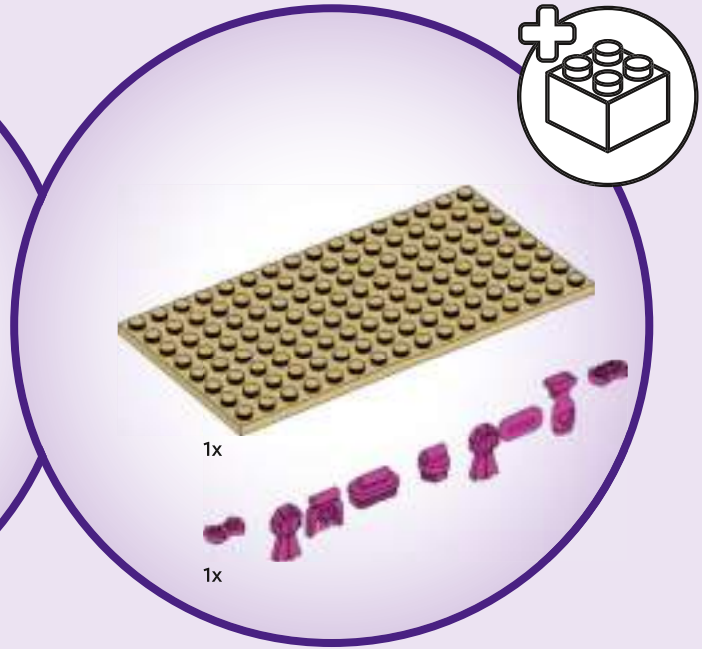

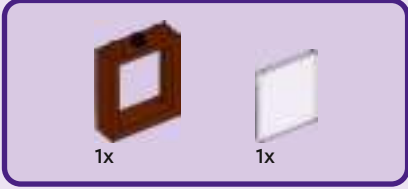

62

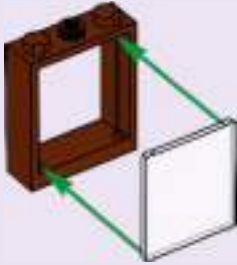

63

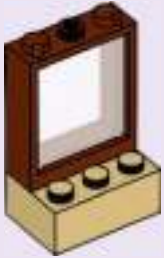



64

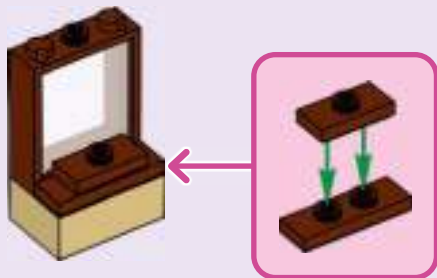

65





3x

66



1x

67

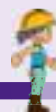



2x



1x

68



1x



1x



1x

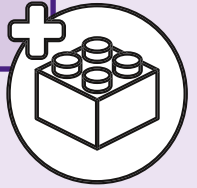

69



70

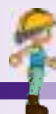



71

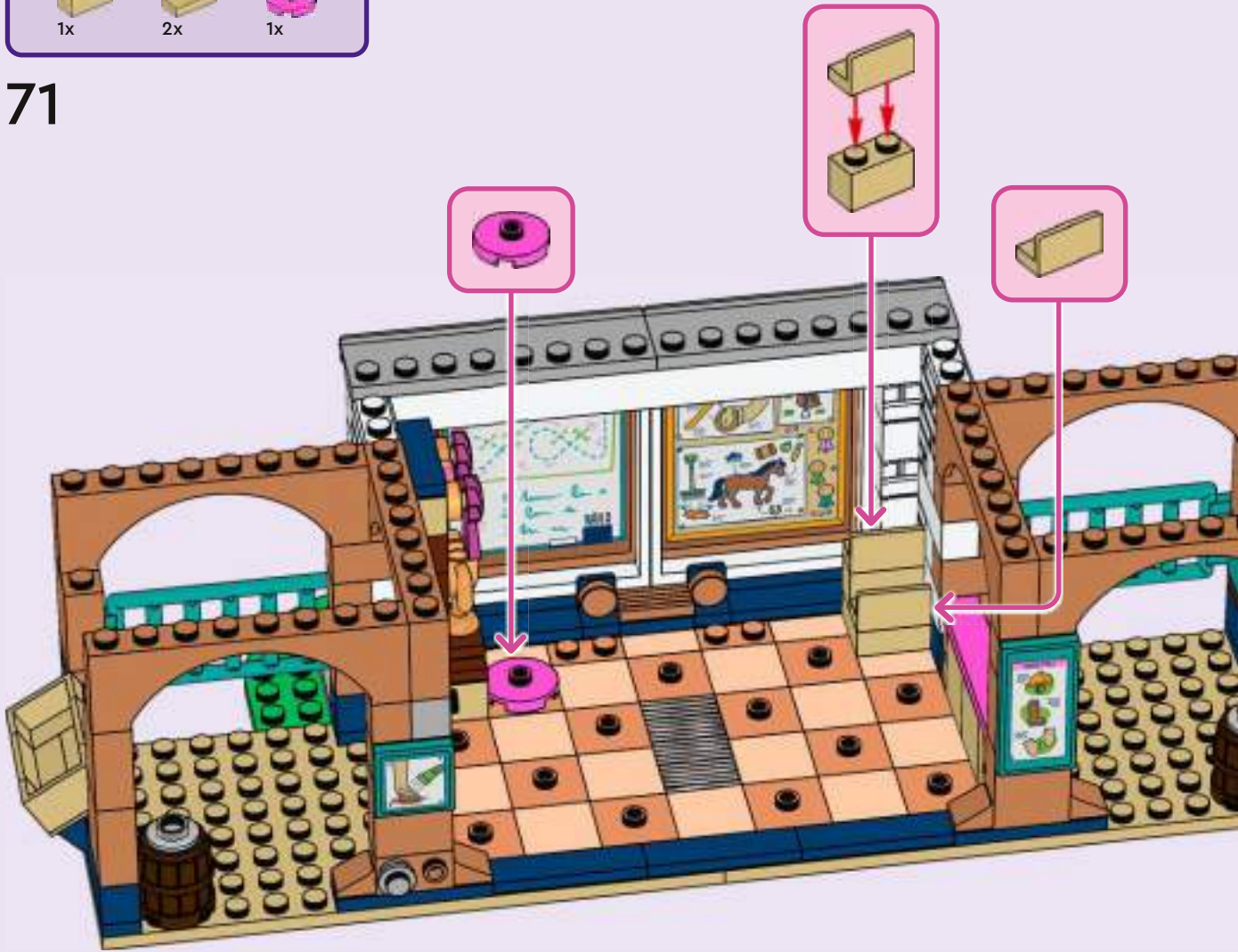

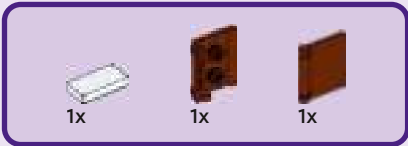

72





73





74

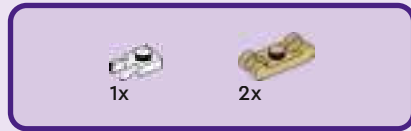
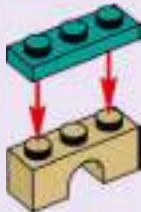

75





1x

76



1x

77





78

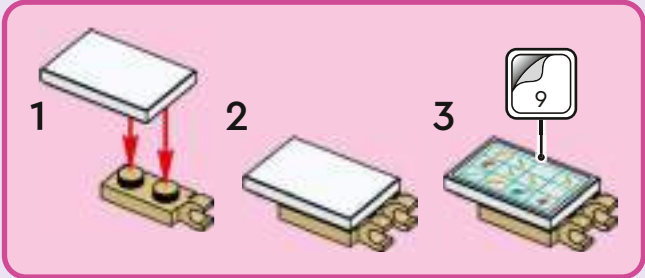

79

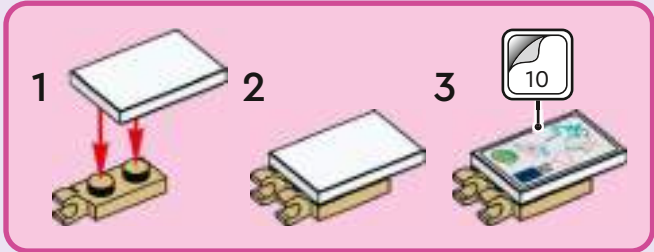

80

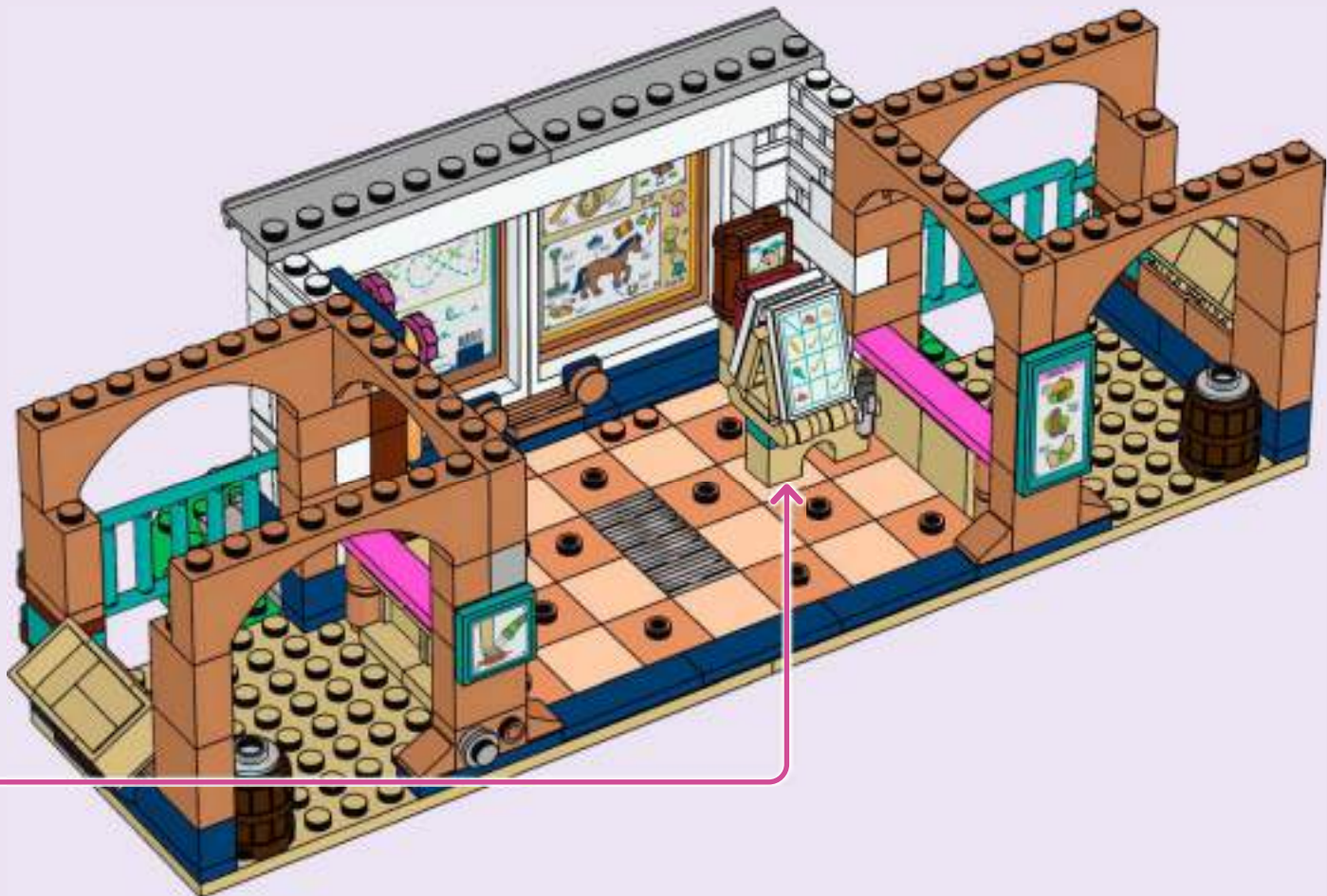

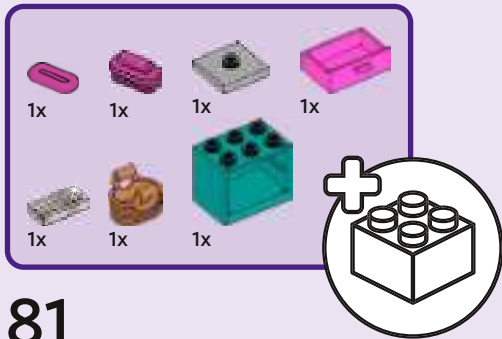

81

1



2



3

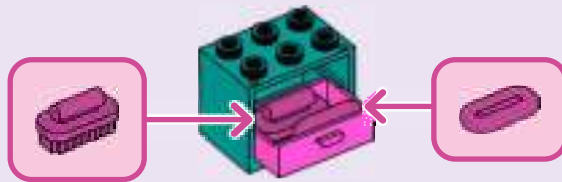

4



5

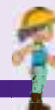

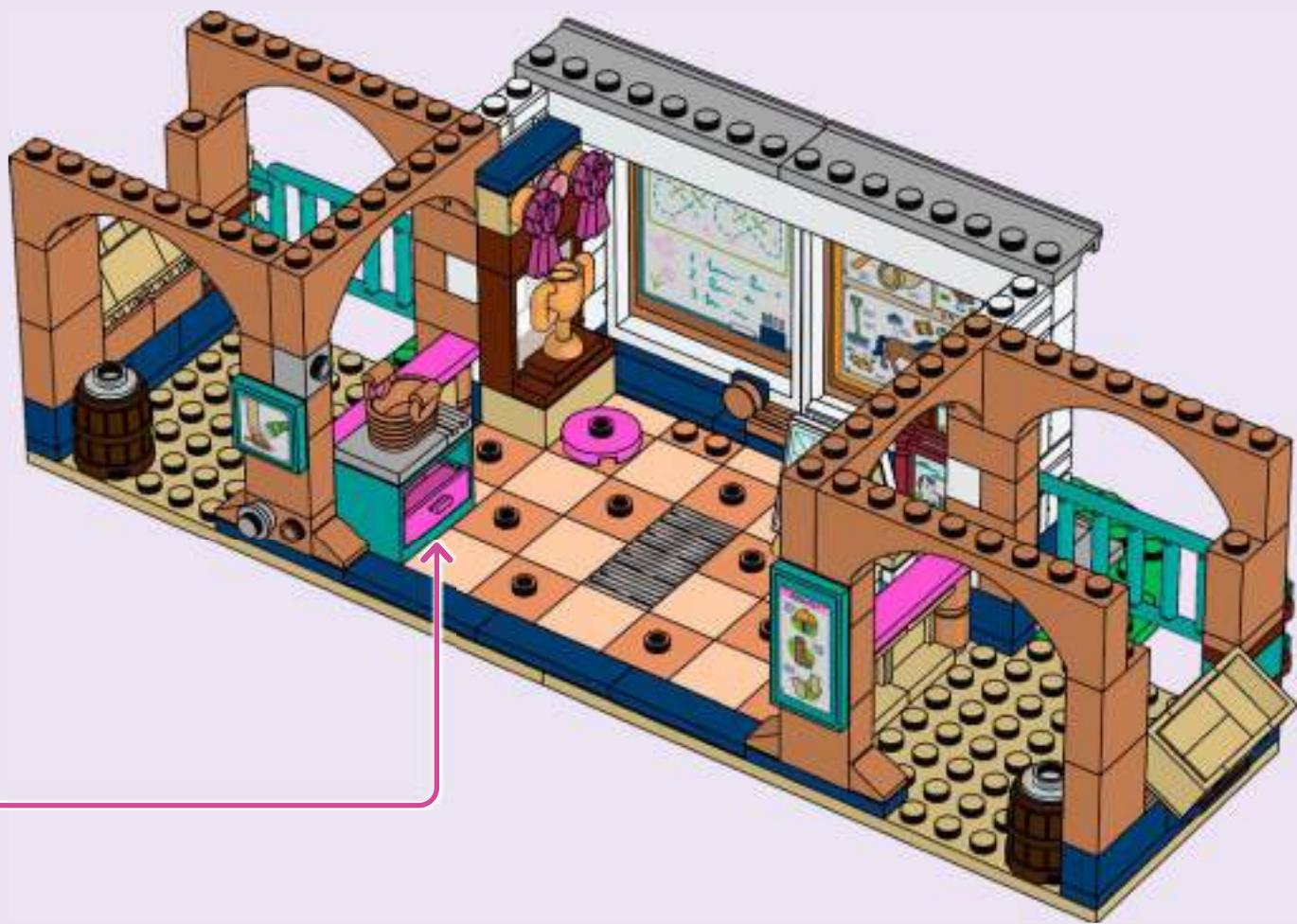

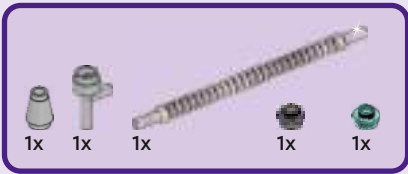

82

1



2



3



4







1x



1x



83



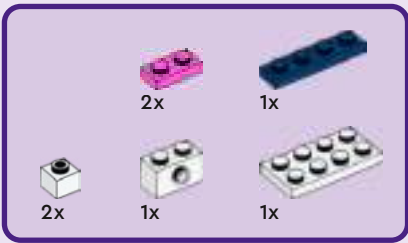

84





85





2x

86





87



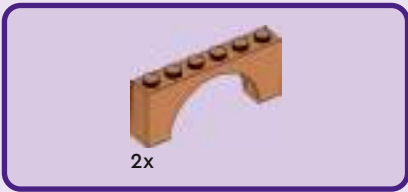

88



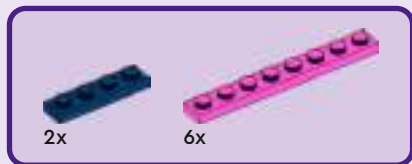

89



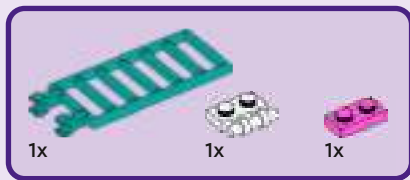

90

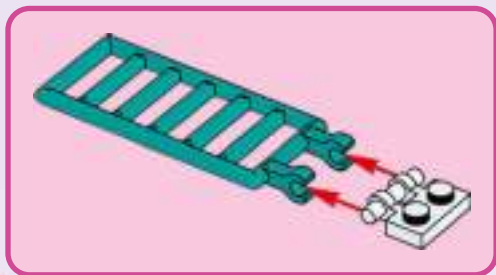



4x



2x

91





92



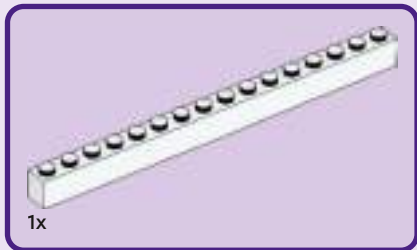

93

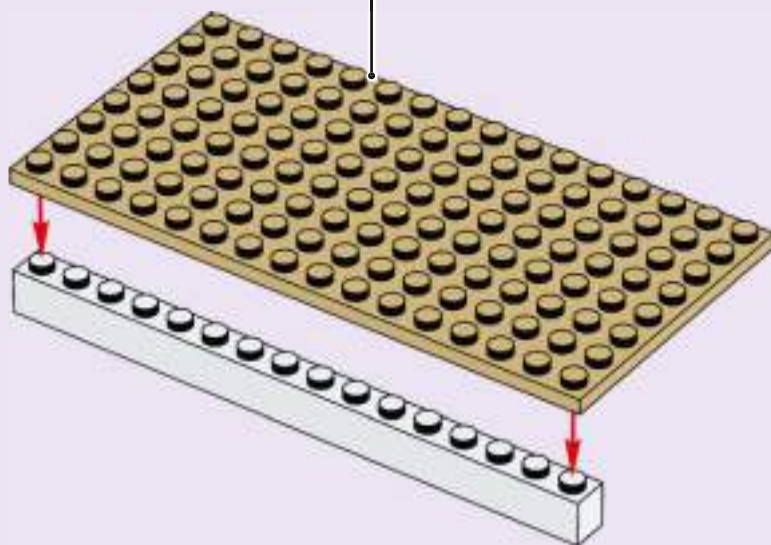
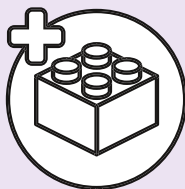

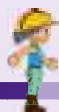



96





2x



2x

97

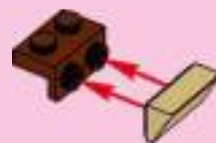

2x



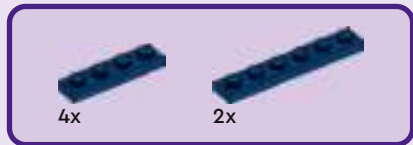

98





99



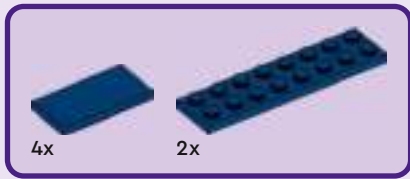

100

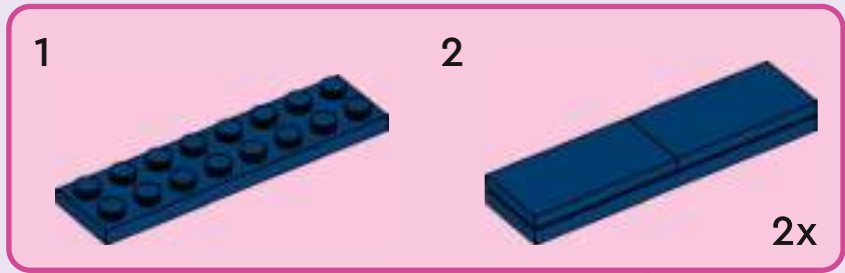



101

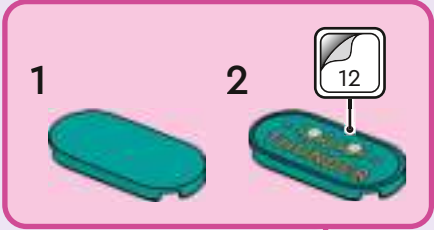







Liann





2x



2x

102



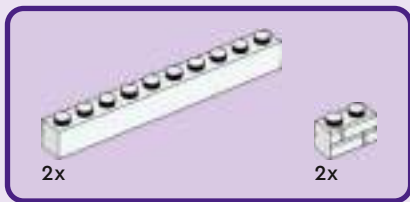

103





2x



2x

104



2x



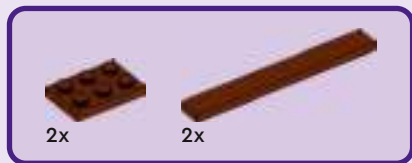

105





2x



2x



4x

106





107

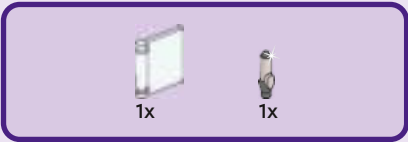

108

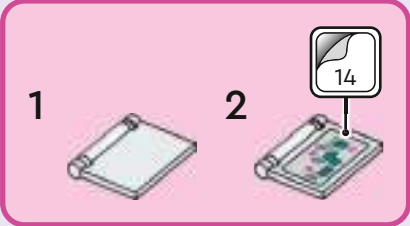

109





110

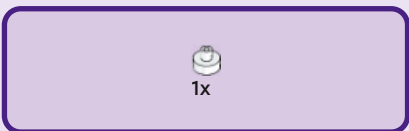

111

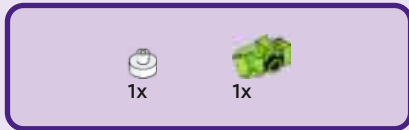

112



113



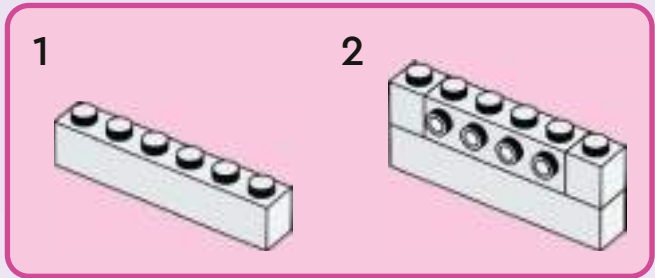
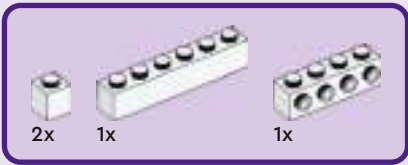

114





115

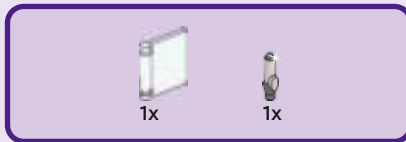

116





1x

117



1x



1x



1x

118



1x



1x

119





120



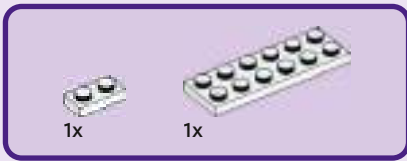

121

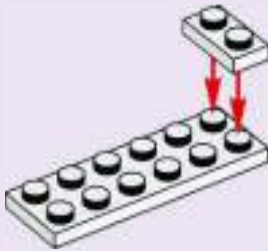

122

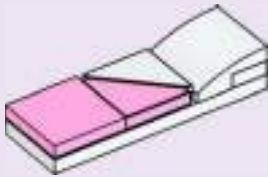

123

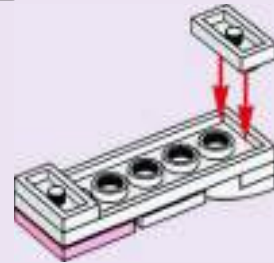
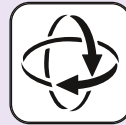

124





1x

125



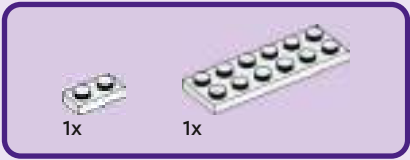

126

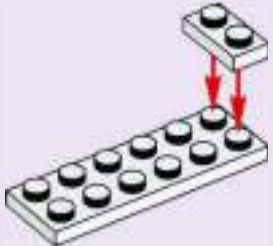

127

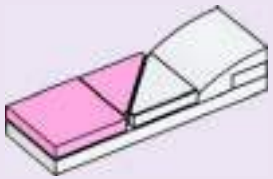

128

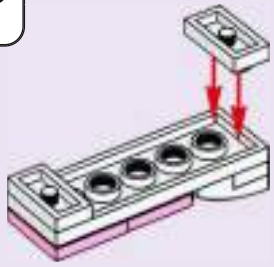

129



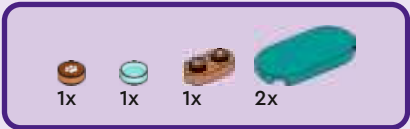

130





131

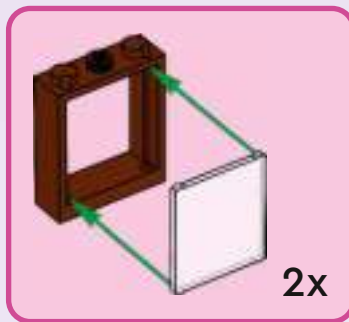



2x



2x

132





2x

133





2x



2x



1x

134





2x



1x

135





2x



1x

136





1x



1x



1x



137





138



139



140





141

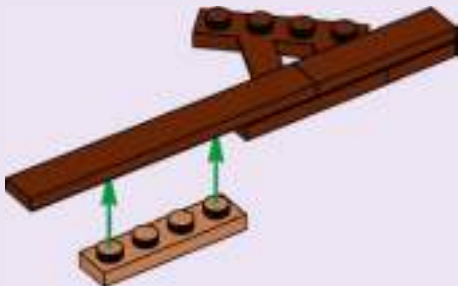

142





143

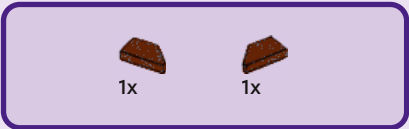

144



145





146

1



2



3



4







147





148

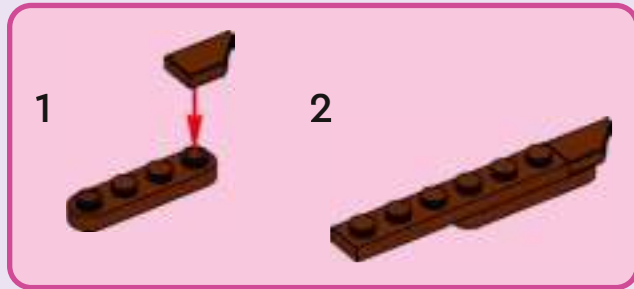



1x

149



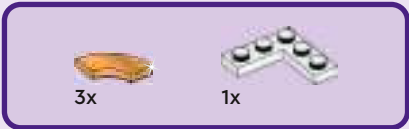

150

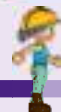
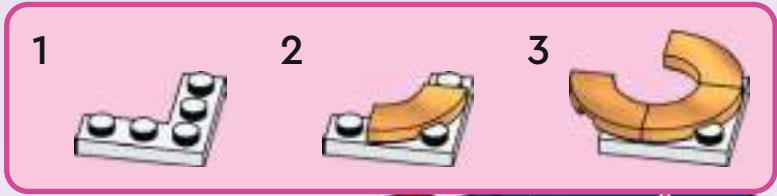



151



152

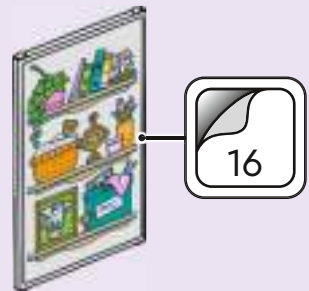



153



154

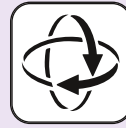



155



156



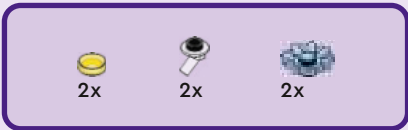

157

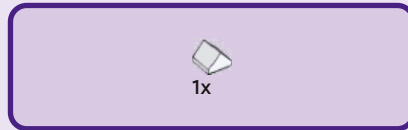

158

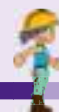

159





160

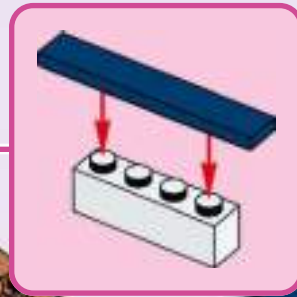

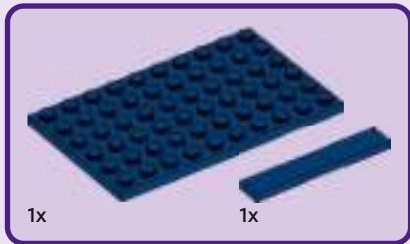

161

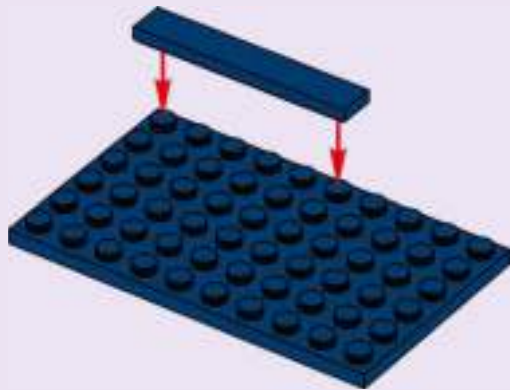

162

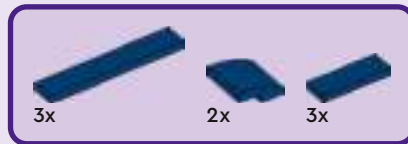
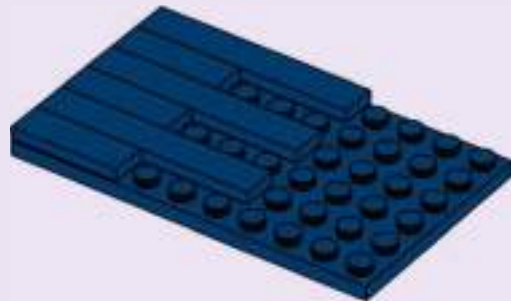

163





1x

164



1x

166

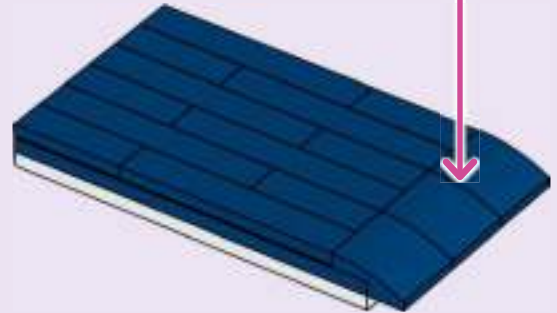

2x



2x



1x

165

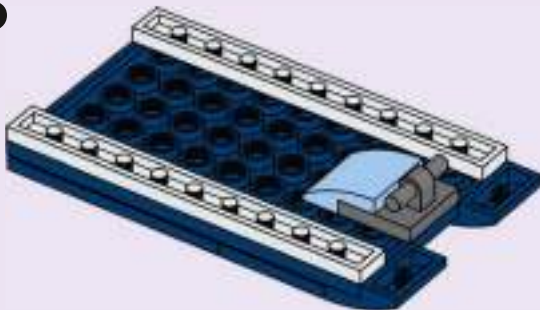

167



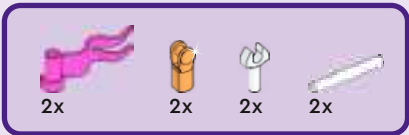

168



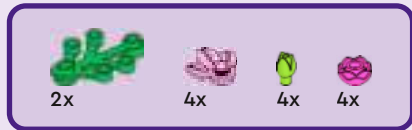

169

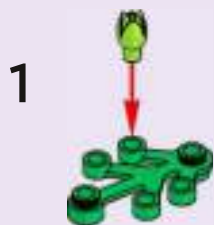





2x



2x

170



2x



2x

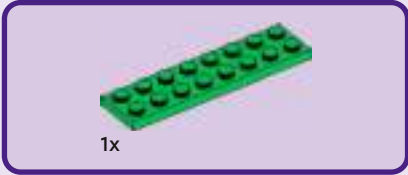

1



2

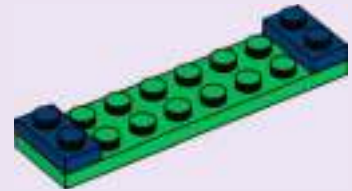



2x



8x



4x



2x



4x

3

1



2



3

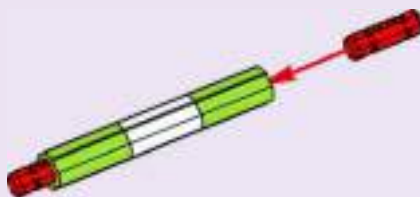

4

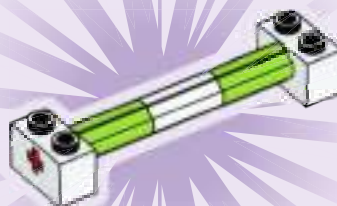

2x



2x

4

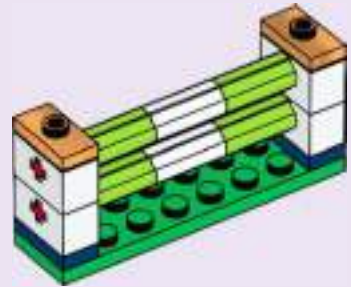
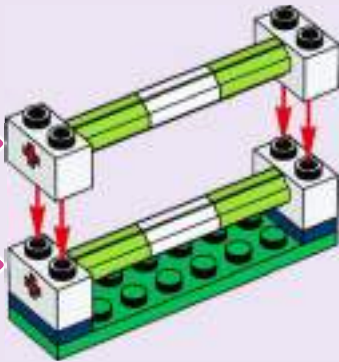



2x

5

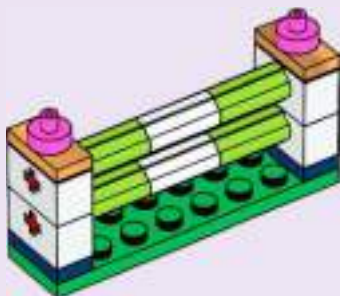

2x

6

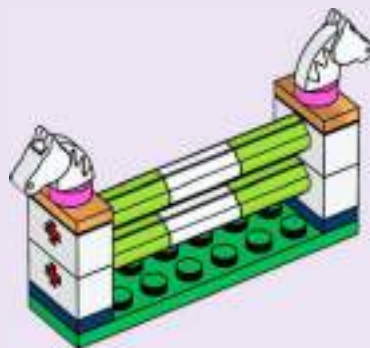



5x
6186681

2x
6439046

15x
300501

1x
6286834

2x
6383985

3x
6525015

2x
4626882

1x
6508268

2x
6233538

1x
6585070

1x
6330191

4x
6212049

2x
306901

4x
4113261

152

23x
6152409

12x
302301

8x
6178921

4x
6383982

10x
4121932

2x
6069002

2x
6217875

1x
4140583

2x
6428803

1x
6126046

2x
6047220

16x
362201

1x
6256050

1x
300201

2x
6156667

2x
4619665

1x
4143254

1x
301001

1x
6428165

1x
302001

2x
6170419

1x
300901

2x
6256127

2x
4181142

2x
379501

2x
300801

4x
447701

2x
611101

2x
246501

3x
4579260

8x
6507789

2x
4624086

4x
6063943

1x
4109995

6x
6146221

4x
6248495

2x
6335307

4x
6374166

2x
6443062

2x
6533760

3x
4114084

1x
4114306

4x
6487881

1x
4618651

1x
6131896

1x
4159739



1x
6037834



3x
4609726

1x
6581581

2x
6330401

13x
6586765

1x
6589141

2x
6206148

16x
4142865

5x
287724

1x
6589027

1x
249626



2x
6586808



1x
6482605



1x
6594024



2x
6550579



2x
302328



3x
6268814



1x
6266968



1x
6431112



1x
303428



2x
6021999



1x
6523035



2x
6380676



1x
6382577



1x
6315197



1x
6589023



2x
6510188



2x
6508150



3x
6581839



1x
6514192



1x
6510163



1x
6514450



1x
6514196



2x
6514193



2x
6424015



2x
6217659



2x
6213779



1x
6273853



1x
6546186



2x
6440111



4x
6346489



1x
6405560



1x
6223065



3x
6586768



1x
6254100



15x
6529813



1x
6476482



5x
6389696



4x
6228123



10x
4153653



4x
6302735



1x
6591732



6x
6061569



4x
6233955



13x
6132566



2x
6186974



11x
4502089



5x
6103985



4x
4569836



2x
4508313



13x
4252437



2x
6250216



2x
6027627



15x
6529813



4x
6228123



2x
6025375



4x
6233955



13x
6132566



2x
6186974



11x
4502089



5x
6103985



4x
4569836



2x
4508313



13x
4252437



2x
6250216



2x
6027627



15x
6529813



4x
6228123



10x
4153653



4x
6228123



2x
6440326



2x
6200659



1x
6585078



1x
6522565



1x
6522536



4x
6422088



1x
6345847



4x
4216581



1x
6253167



1x
6167879

1x
6174229



2x
6570783



2x
6570893



2x
6035291



1x
4531751



3x
6261359



4x
4211150



1x
4211149



1x
6092590



2x
6443654



6x
6459597



3x
6251470



1x
4211220



3x
6502373



2x
6463591



2x
4211189



2x
4211194



1x
4211190



1x
6262952



1x
4211157



1x
6307618



2x
6084573



10x
4221590



1x
6270119



3x
4585337



2x
6313736



1x
4211214



5x
4211525



1x
4529241



1x
4558953



1x
4595836



2x
6126082



1x
6150310



2x
4211356



4x
4222019



2x
6525783



1x
6231765



1x
6542233



2x
6457961



2x
6307633



14x
6550578



1x
6587197



1x
6223767



5x
6057387



1x
6217794



2x
4517992



2x
6555321



3x
6332092



4x
6268863



2x
6147732



2x
4649764



6x
6548252

14x
6443651

1x
6572910

2x
6532058

2x
4615728

1x
6589025

1x
6379176

5x
6330199

11x
6480361

2x
6296657

2x
6186672

2x
6317208

1x
6181575

2x
6092594

3x
6173654

2x
6284589

8x
6300103



1x
6287856

1x
6510192

5x
6057986

1x
6517675

1x
6578429

15x
6401021

3x
6452541

5x
6411587

4x
6347304

4x
4569382

4x
6167690

4x
6177146

2x
6218360

2x
6292154

4x
6167642



1x
6167700

2x
6530832

1x
6035734

2x
6106193

6x
6313662

2x
6605459

2x
6336860

2x
6589024

3x
6446980

5x
4619636



1x
6194553

1x
6566162



2x
4620909

1x
6029690

1x
6416663

1x
6589140

1x
6416546

1x
6589142

1x
6581584

 [LEGO.com/service](https://www.LEGO.com/service)



YOU COULD WIN



Scan this QR code or go to **LEGO.COM/PRODUCTFEEDBACK** and give us your short feedback about this LEGO® set for a chance to win a cool LEGO prize.

Terms and Conditions apply*

EN: YOU COULD WIN. Terms and Conditions apply* **DE: Du könntest GEWINNEN.** Es gelten die Teilnahmebedingungen* **FR: Tu pourrais GAGNER.** Des conditions s'appliquent* **IT: Potresti VINCERE tu.** Termini e condizioni sono applicabili* **ES: Puedes GANAR.** Aplican términos y condiciones* **PT: PODERÁ GANHAR.** Aplicam-se Termos e Condições* **ZH: 轻松获奖. 条款和条件适用*** **PL: Szansa na WYGRANĄ.** Obowiązuje regulamin* **CS: Máte šanci VYHRÁT.** Platí všeobecné smluvní podmínky* **SK: Máte šancu VYHRAŤ.** Platia všeobecné zmluvné podmienky* **HU: TE IS NYERHETSZ.** Felhasználási feltételek érvényesek* **UA: ВИ МОЖЕТЕ ВИГРАТИ.** Застосовуються загальні положення та умови* **RO: Ai putea CÂȘTIGA.** Se aplică termeni și condiții* **BG: Можете да СПЕЧЕЛИТЕ.** Има определени правила и условия* **LV: Tu vari LAIMĒT.** Ir spēkā noteikumi un nosacījumi.* **ET: Sul on võimalus VÕITA.** Kehtivad tingimused* **LT: Jūs galite LAIMĖTI.** Taikomos sąlygos* **LEGO.com/productfeedback-terms*

LEGO, the LEGO logo and the FRIENDS logo are trademarks of the LEGO Group. ©2026 The LEGO Group.