

DW8630

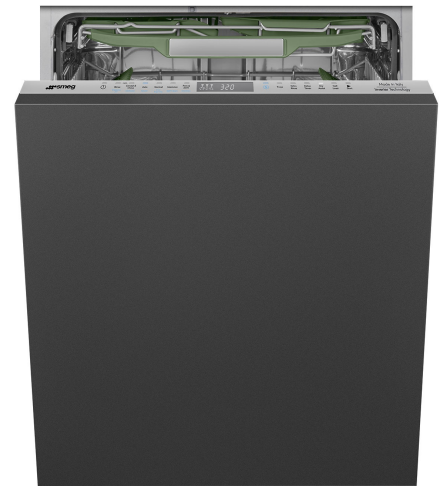

| | |
|-------------------|------------------|
| Product family | Dishwashers |
| Commercial height | 86 cm |
| Installation | Fully-Integrated |
| N° baskets | 3, FlexiDuo |
| Engine | Inverter |
| EAN code | 8017709355258 |



Programs



| | | | |
|----------------------|-------------------------------|-----------------|-----|
| Number of programs | 12+2 | Auto | Yes |
| Washing temperatures | 38, 45, 50, 55, 65, 70, 75 °F | Rinse | Yes |
| Express 27' | Yes | Crystal & China | Yes |
| Mix | Yes | Eco express | Yes |
| Self Clean | Yes | Pots & Pans | Yes |
| Sterilize | Yes | Trays | Yes |
| Delicates | Yes | | |

Options



| | | | |
|----------------------------|----------------|-------------------------------|-----|
| Dry Assist option | Yes | Intensive washing zone option | |
| Delay start | Up to 24 hours | Special programs option | Yes |
| FlexiZone half-load option | Yes | Clean&Shine option | Yes |

Baskets



| | | | |
|--------------------------------|------------------|---------------------------------------|------------------------------------|
| Basket color | Gray | Lower basket accessories | MultiLoad, ProFlex Holder, WinePro |
| Upper basket | 3 foldable racks | Lower basket with anti-drip inserts | Yes |
| Upper basket height adjustment | On 3 levels | Largest loadable dish in lower basket | 35,0 inches |

| | | | |
|---------------------------------------|-----------------------|-------------------------|-----------|
| Sliding Guides Extra Glide | Yes | Colour Inner Components | Sage Leaf |
| Largest loadable dish in upper basket | 19,0 inches | Cutlery basket | Yes |
| Lower basket | With 4 foldable racks | | |

Technical Features



| | | | |
|-------------------------|--|---|---|
| Width | 23 9/16 " | Max water hardness | 100°FH;58°dH |
| Depth | 21 5/8 " | Drying system | Natural condenser drying, with Dry Assist automatic door opening system at the end of the cycle |
| Display type | LED display (3 digits) | Internal lighting | White LED |
| Height | 33 3/4 " | Internal lighting | White LED |
| Display | Delay start, Program progress indicator, Time-to-end indicator, Consumptions | Tub material | Stainless steel |
| Program symbols | Writings in English | Filter | Stainless steel |
| Salt indicator | Light | Concealed heating element | Yes |
| Rinse aid indicator | Light | Hinges | Self-balancing, Sliding, FLEXIFIT |
| End-of-cycle indicator | ActiveLight | Min. and max. frontal panel weight | 4.4 - 22 lbs |
| Auto switch-off | Yes | Min. and max plinth height | 50 - 215 mm |
| Washing system | Planetarium | Adjustable feet | 2 3/4", from 33 7/8" to 36 5/8" |
| Third spray arm | Single | Additional gaskets | Yes |
| Water softener | With electronic setting | Back cover | Yes |
| Turbidity sensor | Yes | Depth of dishwasher with open door (mm) | 1186 mm |
| Aquatest | | Top cover | Metal sheet |
| Flood protection system | Total Aquastop | | |

Electrical Connection

| | | | |
|-----------------|--------|---------------------------|----------------|
| Connected power | 1100 W | Connection type | Single-phase |
| Current | 13 A | Power supply cable length | 140 " |
| Voltage | 115 V | Plug | (B) NEMA 5-15P |
| Frequency (Hz) | 60 Hz | | |

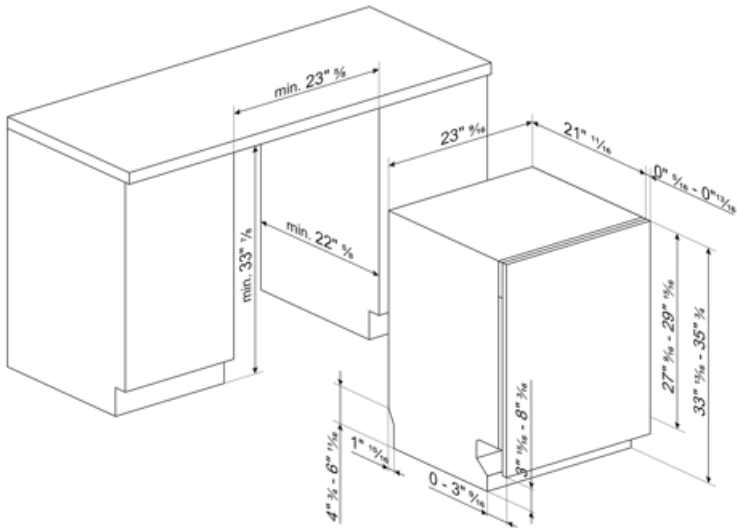

Compatible Accessories



KIT86PORTAN-1

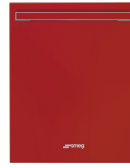

KIT86PORTRD



KIT86SPRAN



KIT86SPRMW



KIT86SPRX



KITFLEXI

KITJBDW



KITPL60B

Toe kick Kit in White colour with adjustable height and deepness. Can be installed over all the fully integrated and underbench models with variable fulcrum or flexifit hinges.

KITPL60N

Toe kick Kit in Black colour with adjustable height and deepness. Can be installed over all the fully integrated and underbench models with variable fulcrum or flexifit hinges.



KITPL60X





















Toe kick Kit in Stainless Steel with adjustable height and deepness. Can be fitted over all the fully integrated and underbench models with variable fulcrum or flexifit hinges.





KITPLV2

Kit extension for dishwasher and washing machine: lenght mt. 2



Symbols glossary

| | |
|---|--|
|  <p>Active Light is an led light which projects a red spot onto the floor beneath the dishwasher when the appliance is in use.</p> |  <p>Aquatest measures the clarity of the water during an auto program, and automatically ensures the minimum consumption of water and energy.</p> |
|  <p>Anti-drip: Some models of dishwashers are equipped with special polymer nozzles anti-drip, that improve the process of drying.</p> |  <p>COMM_HEIGHT_86_72dpi</p> |
|  <p>Delay Timer: The delay timer can postpone the start of the program by up to 24 hours.</p> |  <p>Energysave: At the end of the drying cycle a special device slowly automatically opens the door a few centimeters, to ensure perfect drying and to save up to 20% of energy on some models.</p> |
|  <p>FlexiDuo: The FlexiDuo 3rd cutlery basket allows you to arrange cutlery or small cups, ladles, or bulky utensils however you like: it consists of two separate and moveable modules.</p> |  <p>Models with new Flexi Fit hinges are able to be installed in kitchens with a plinth of just 5cms. With this new hinge design, the panel has a sliding movement from the bottom to the top, avoiding any possible interference of the panel with the plinth.</p> |
|  <p>FlexiZone: The ½ load flexizone allows you to wash a reduced load saving energy, water and time and there are no restrictions on where the items are placed.</p> |  <p>The new ExtraGlide guide system, available on top of the range models, makes the second basket even smoother and softer. In fact, it facilitates the extraction of the introduction, even at full load and, for the greater excursion, the insertion of crockery is also facilitated in the rear part.</p> |
|  <p>Inverter technology: The evolution of Smeg's driers towards more intelligent and environmentally sustainable models has led to the choice of using Inverter technology with heat pumps, which reduces significantly energy consumption.</p> |  <p>PLANETARIUM_WASHING_SYSTEM_72dpi</p> |
|  <p>Delicate: Delicate washing program is designed for delicate dishes which are not heavily soiled.</p> |  <p>Delicate: Delicate washing program is designed for delicate dishes which are not heavily soiled.</p> |
|  <p>PRG_RINSE_72dpi</p> |  <p>Rapid 27 Mins: The rapid 27 mins quick program takes just 27 minutes to wash a load.</p> |
|  <p>Total Acquastop: In addition to the partial Acquastop protection present in all Smeg dishwashers, some models have an electronic device fitted to the water intake hose, which monitors water levels in the machine, detects leaks in the hose and switches off the water supply immediately when necessary.</p> |  <p>System WaterSave ensures the best washing results with minimal water consumption depending on the model of dishwasher.</p> |
|  <p>Dishwasher cleaning cycle. The cycle should be started with the machine empty, without dishes. It is recommended to run the program every 2-3 months, using special dishwasher detergents.</p> |  <p>SILENT: Wash cycle suitable for normally soiled dishes, even with dried-on residues. Ensures maximum noise reduction and is therefore ideal if you wish to run it during the night.</p> |

-
- | | |
|---|---|
|  Allows you to enable additional programs when selected together with any wash cycle. |  STERYL 75°: Intensive wash cycle ideal for plates, pots, pans, cutting boards, feeding bottles. |
|  Clean&Shine option: For perfect cleaning results, this option adds an extra rinse to the wash cycle, which also gives the dishes a higher gloss. |  Baking tray programme: for intensive cleaning of the oven trays. Place the trays in the lower basket of the dishwasher. |