



CREATOR™



31379



LEGO® Builder



Get excited about our new packaging!

We're switching from plastic to paper-based packaging. That's why you might find a mix of paper and plastic in our boxes!

Nos nouveaux emballages vous emballeront !

Nous passons des emballages en plastique aux emballages à base de papier. C'est pourquoi vous pourriez trouver un mélange de papier et de plastique dans nos boîtes !

¡Te presentamos nuestros nuevos empaques!

Estamos sustituyendo las bolsas de plástico por bolsas con base de papel. ¡Por eso, puedes encontrar una mezcla de papel y de plástico en nuestras cajas!

[LEGO.com/sustainable-packaging](https://www.lego.com/sustainable-packaging)



BUILDER



Apple and the Apple logo are trademarks of Apple Inc., registered in the U.S. and other countries and regions. App Store is a service mark of Apple Inc. Google Play and the Google Play logo are trademarks of Google LLC. Tencent and the Tencent logo are trademarks of Tencent Inc.

Q [LEGO.com/devicecheck](https://www.lego.com/devicecheck)

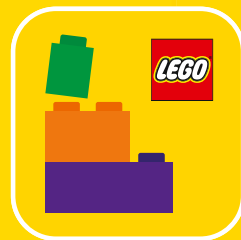

Q LEGO® Builder

EN Ask parents' permission before going online | DE Eltern um Erlaubnis bitten, bevor du online gehst | FR Demande l'autorisation d'un parent avant d'aller en ligne | IT Chiedi il permesso ai tuoi genitori prima di andare online | ES Pídeles permiso a tus papás antes de conectarte a Internet | PT Peça autorização aos pais antes de acederes online | ZH 上网前应先征得父母的同意 | PL Poproś rodziców o zgodę, zanim wejdiesz do Internetu | CS Než půjdeš na internet, požádej rodiče o svolení | SK Skôr než pôjdeš na internet, vypýtaj si povolenie od rodičov | HU Kérj szülői engedélyt, mielőtt online csatlakoznál! | UA Запитуйте дозволу батьків, перш ніж користуватися інтернетом | RO Cere permisiunea părinților înainte de a te conecta online | BG Поискайте разрешение от родител, преди да влезете онлайн | LV Pirms došanās tiešsaistē palūdz atļauju vecākiem | ET Enne Interneti kasutamist küsi vanematelt luba | LT Prieš prisijungdami prie interneto, atsis klauskite tėvų

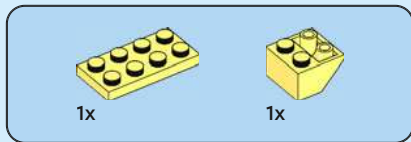

1

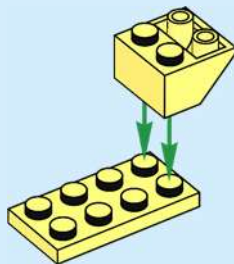

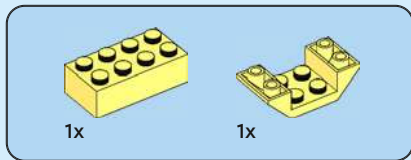

2

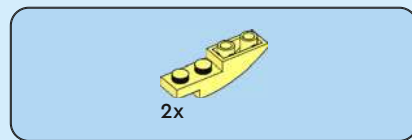
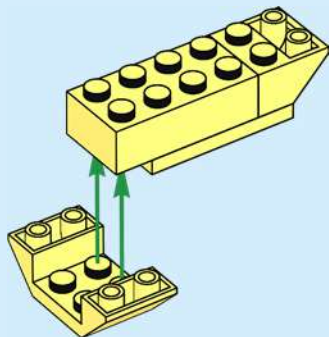

3

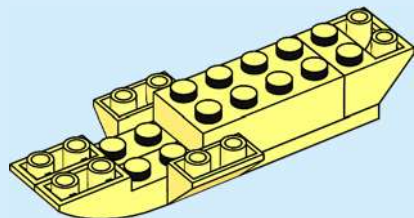



4

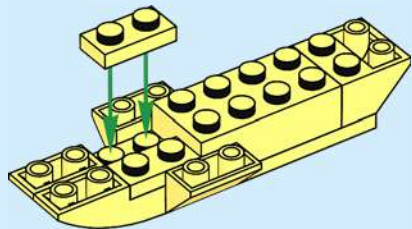

5

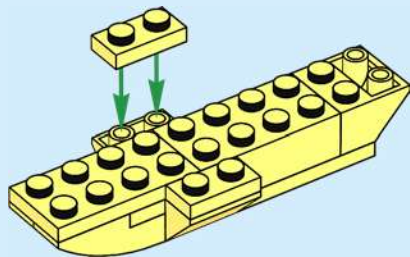

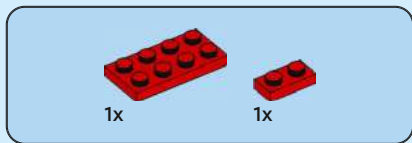

6

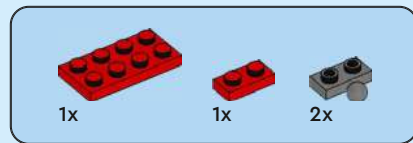
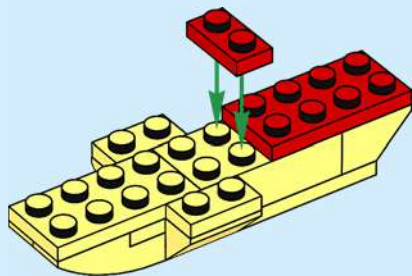

7

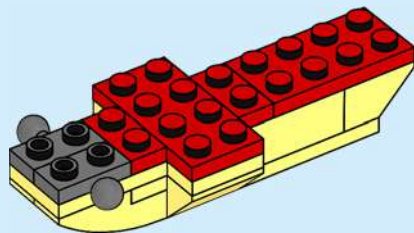

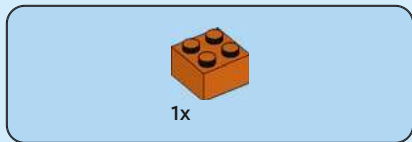

8

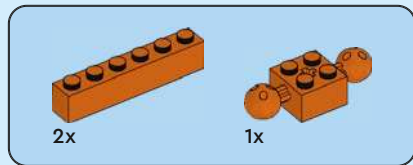
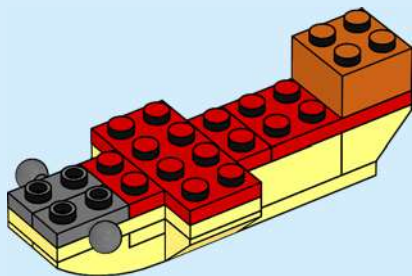

9

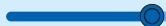
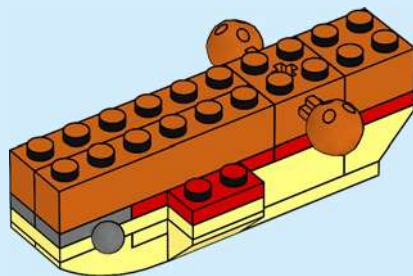



4x

10

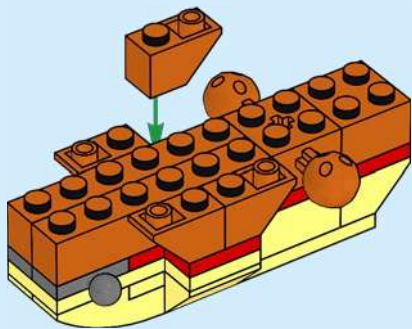

1x



1x

11

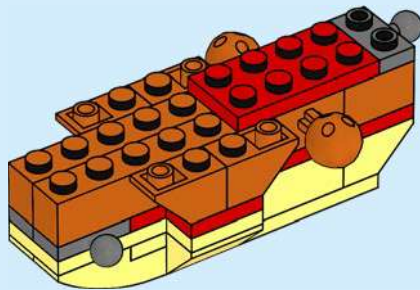

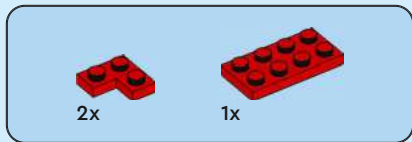

12

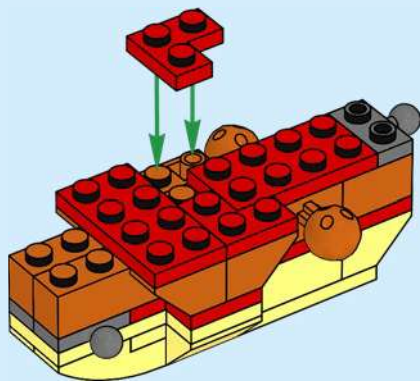

13

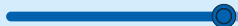
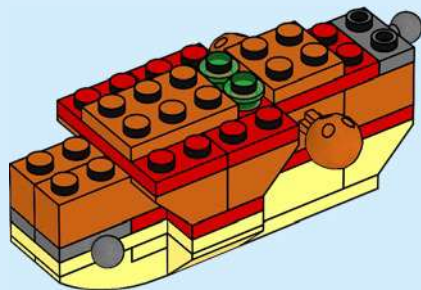



2x

14

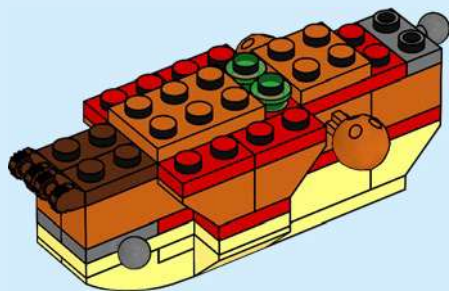

1x

15

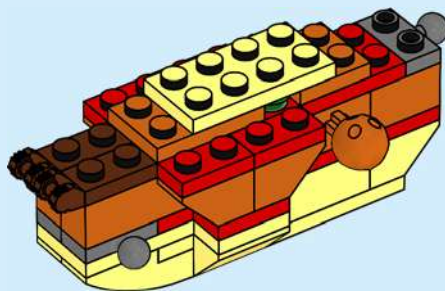

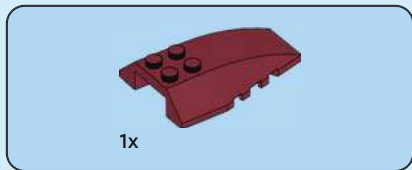

16

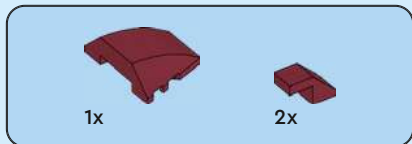
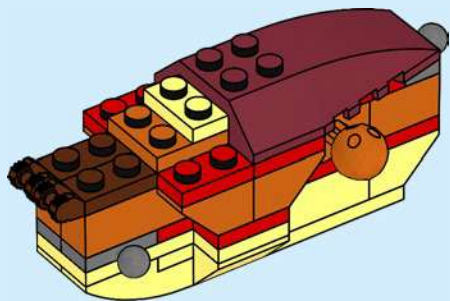

17

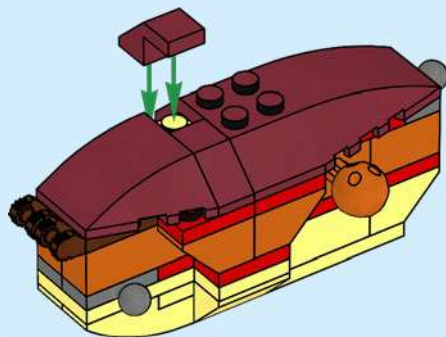

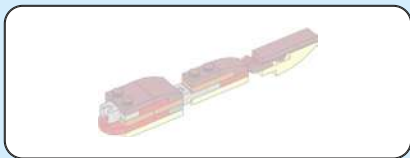

18

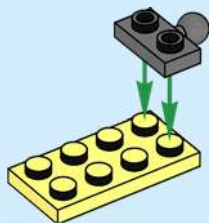

19

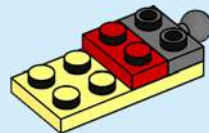

20





2x

21

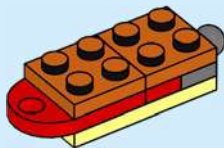

2x



1x

22

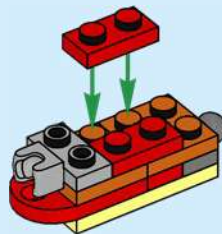

1x



1x

23



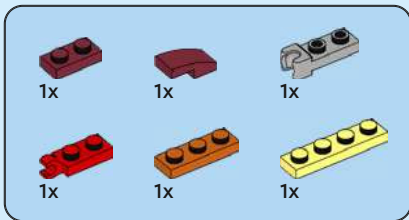

24

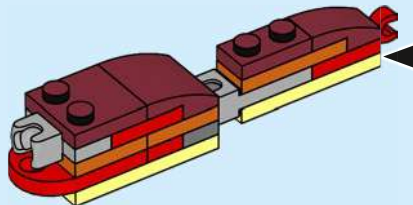
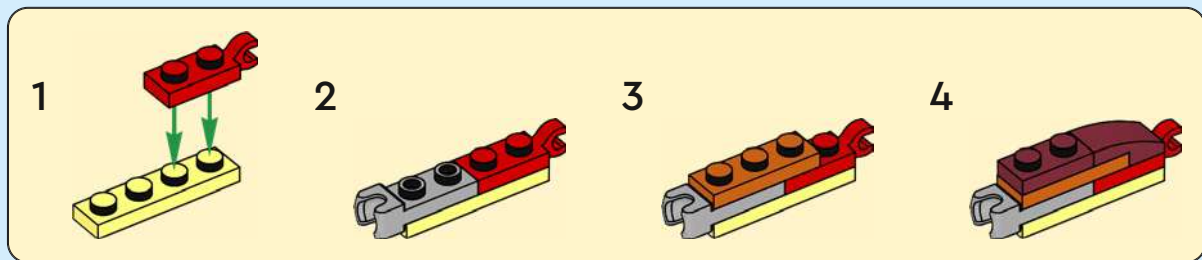

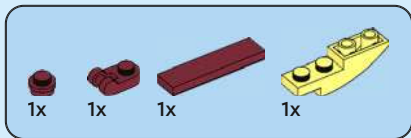

25

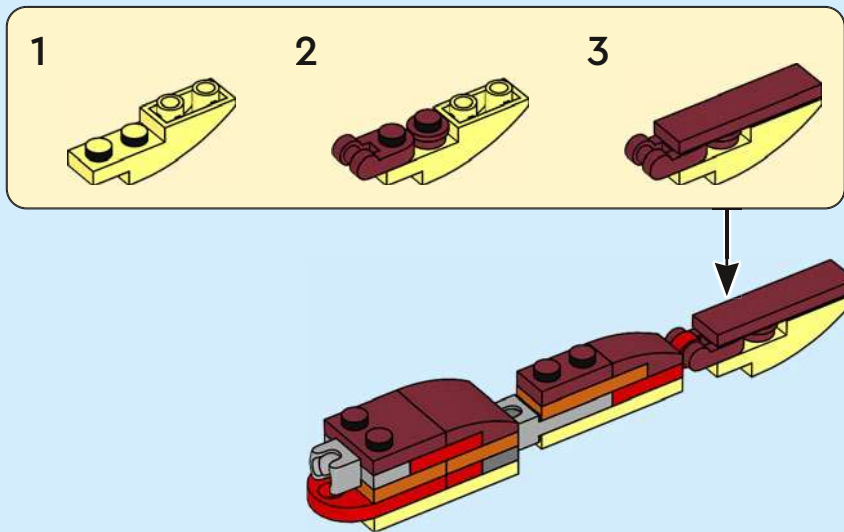

26

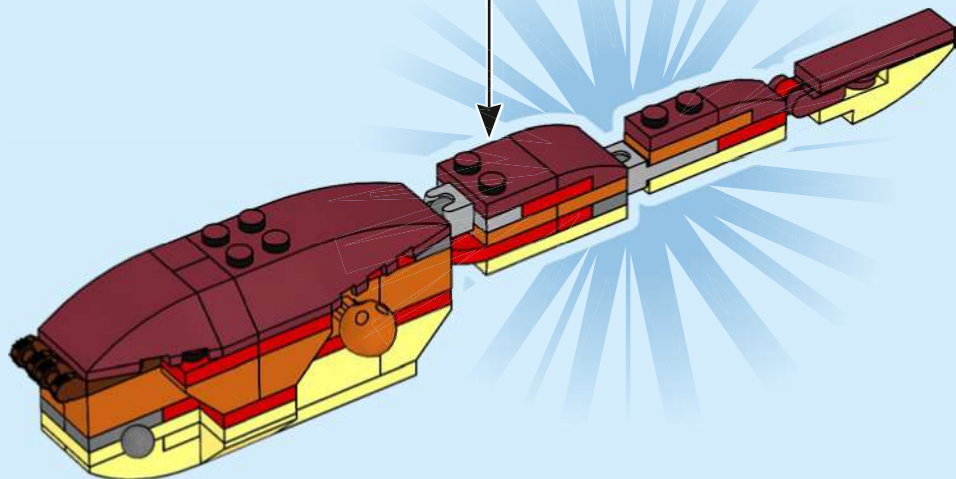

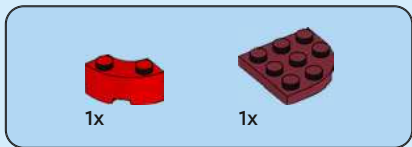

27

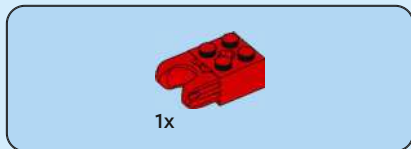
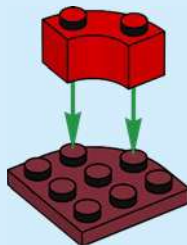

28

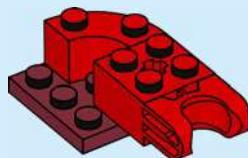

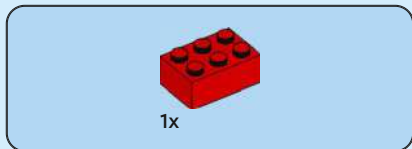

29

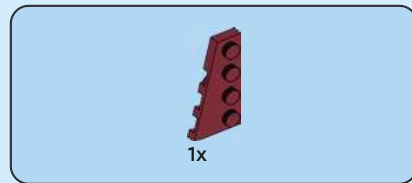
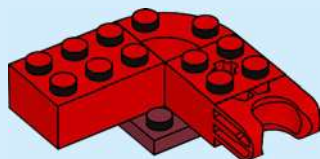

30

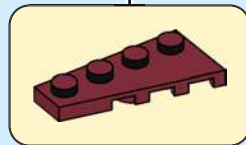
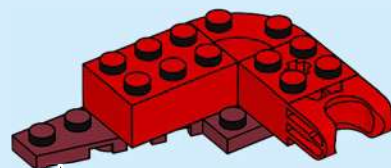



1x

31

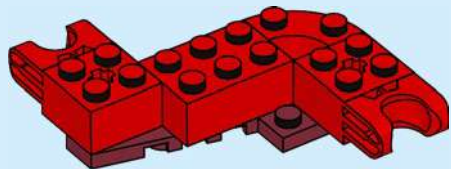

1x



1x

32

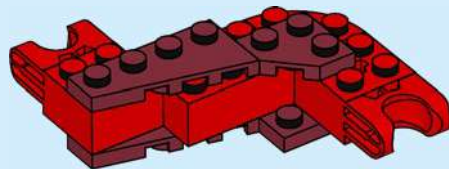



1x



1x

33

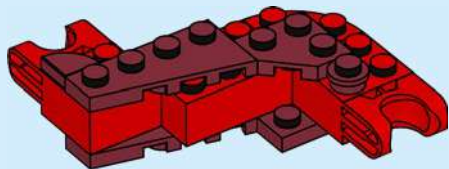

1x



1x



1x

34

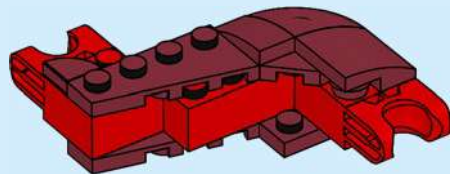

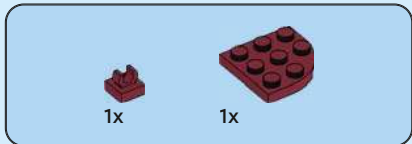

35

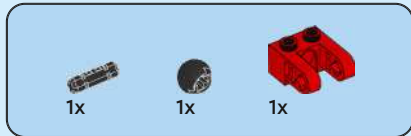

36

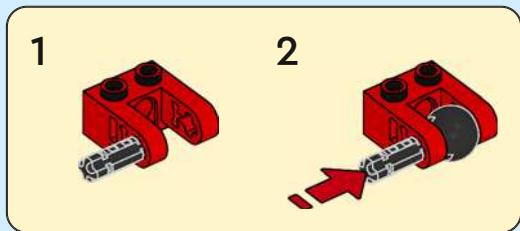



37



38



39





1x



1x

40

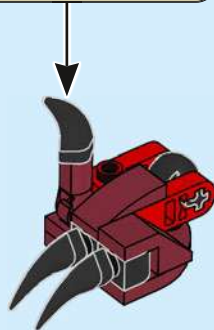
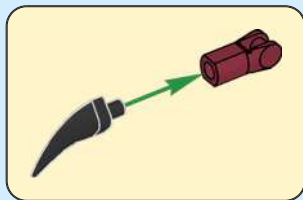

41

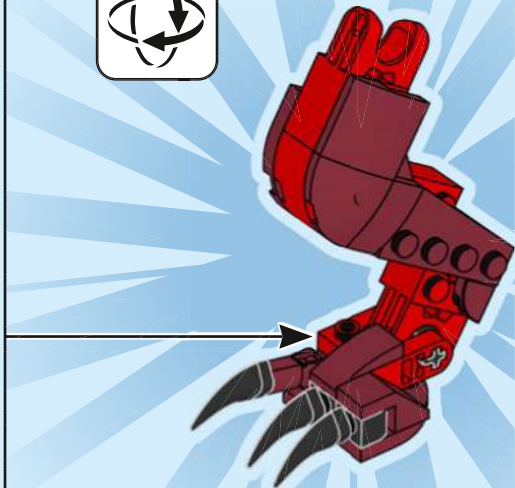

42

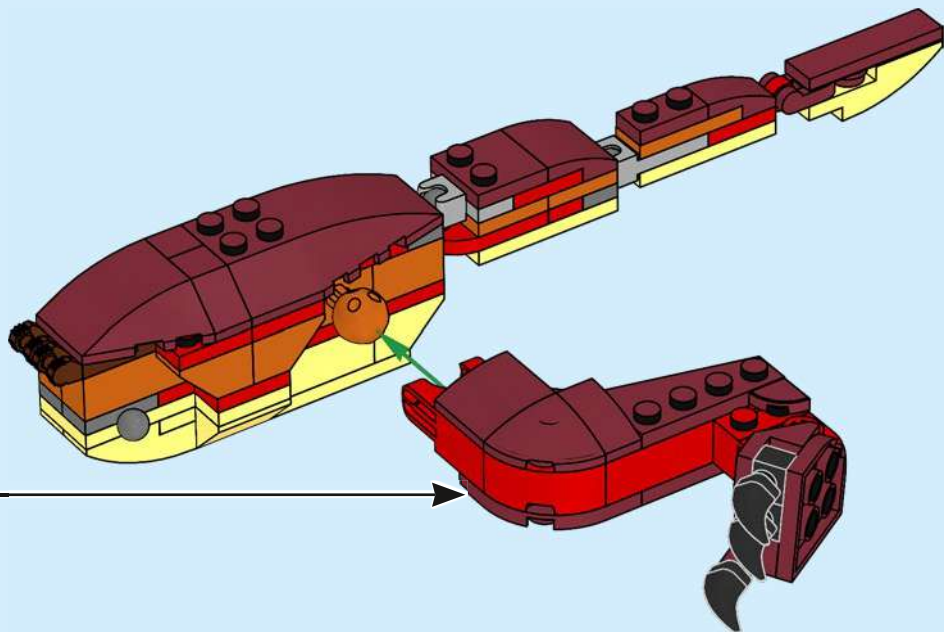



43

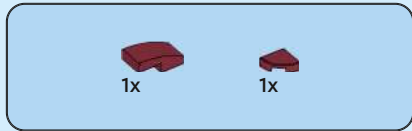
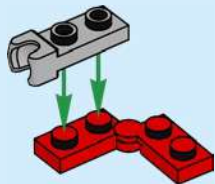

44

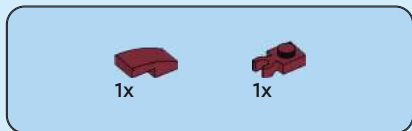

45

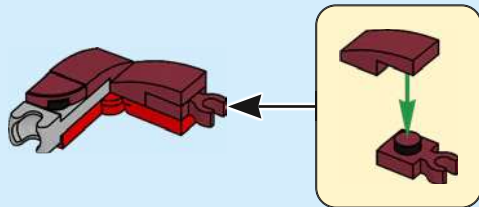



46

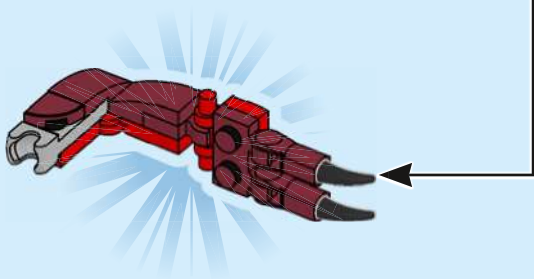
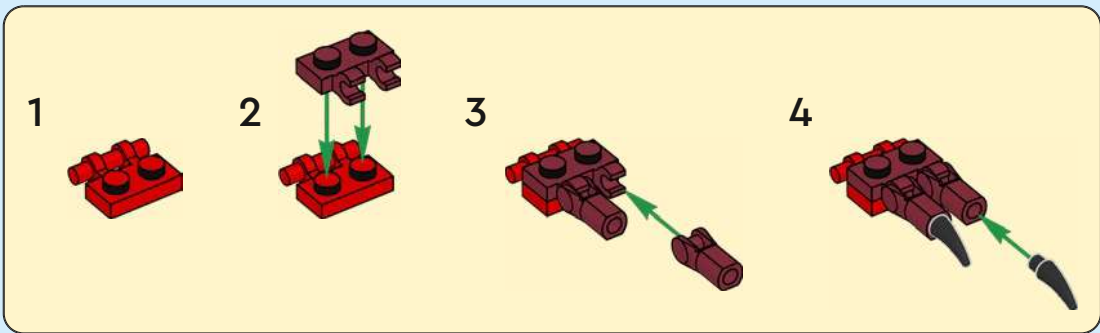

47

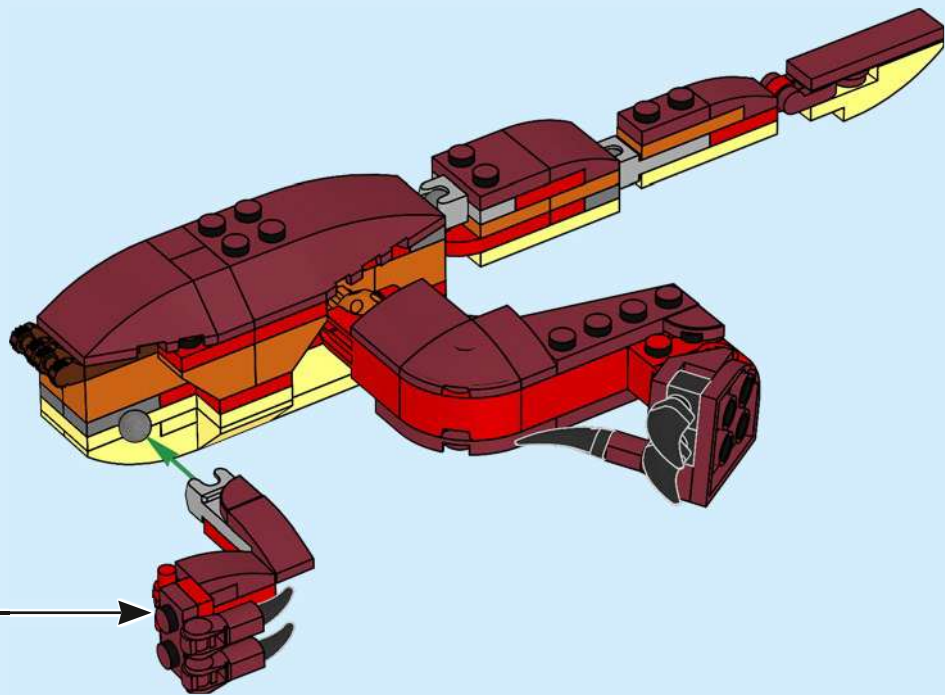

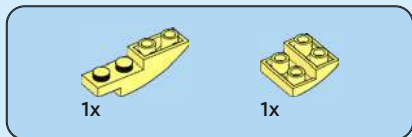

48

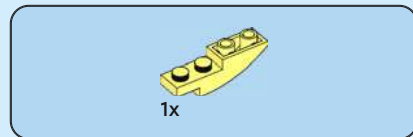
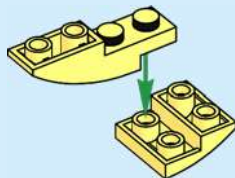

49

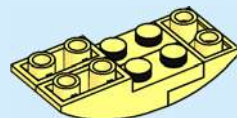

50

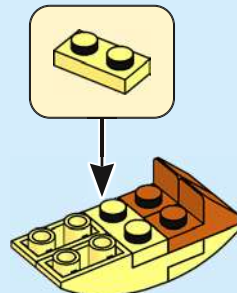



2x



1x

51

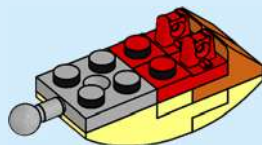

1x

52

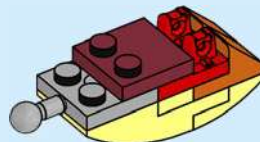

1x

53



54

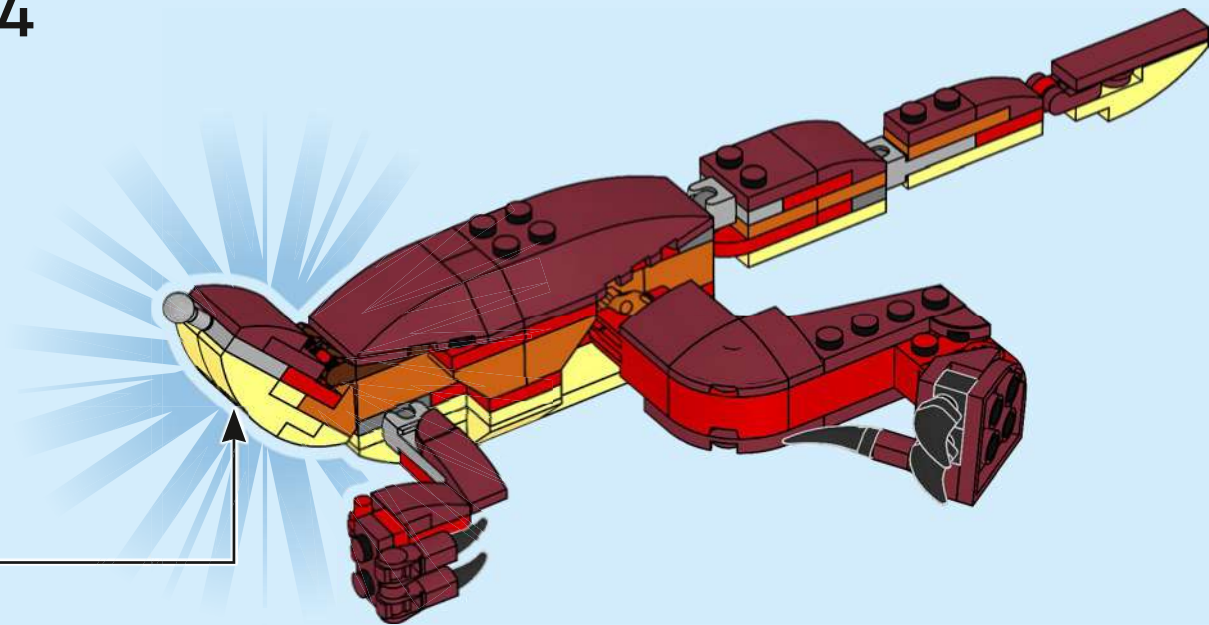

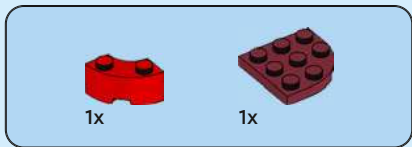
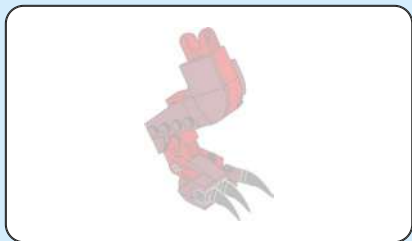

55

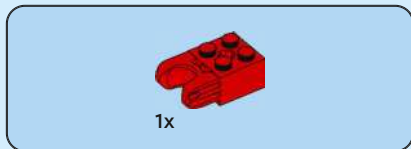
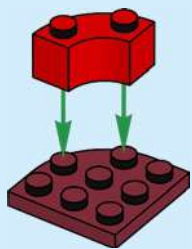

56

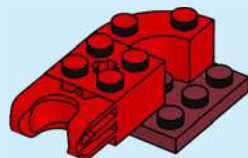

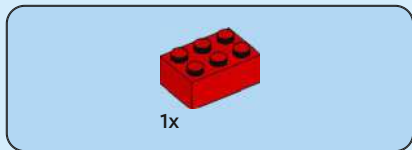

57

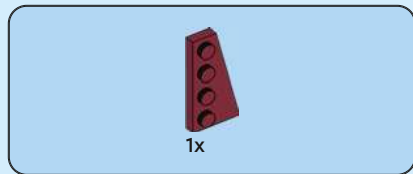
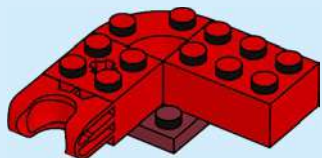

58

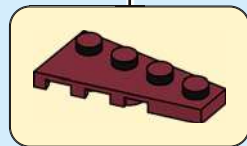
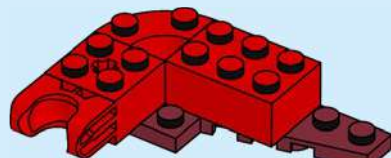



1x

59

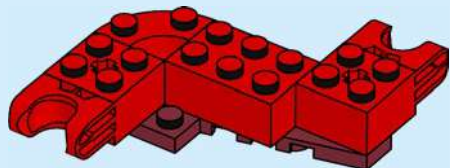

1x



1x

60

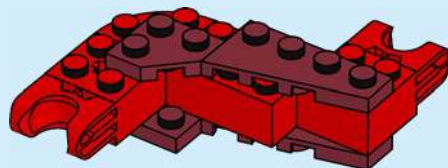



61

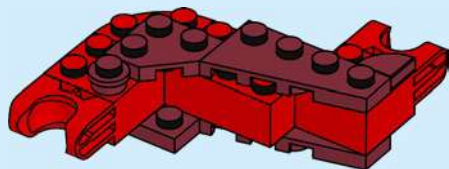

62

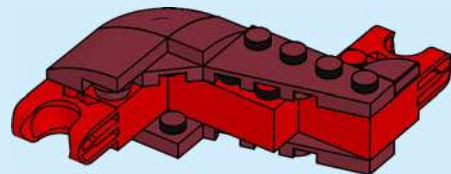



63

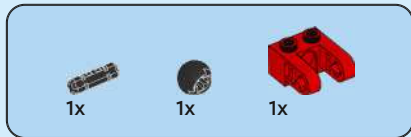
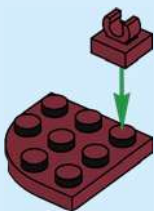

64

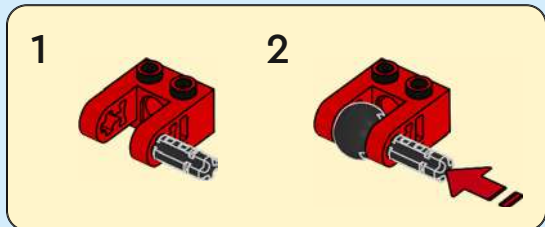



2x

65



1x



1x

66

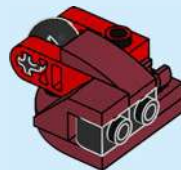

2x

67





1x



1x

68

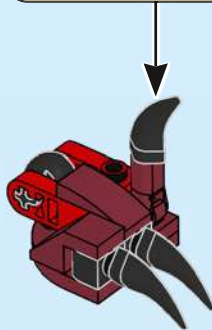
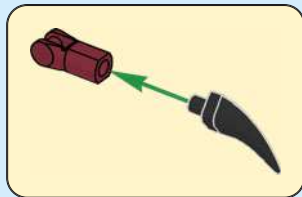

69

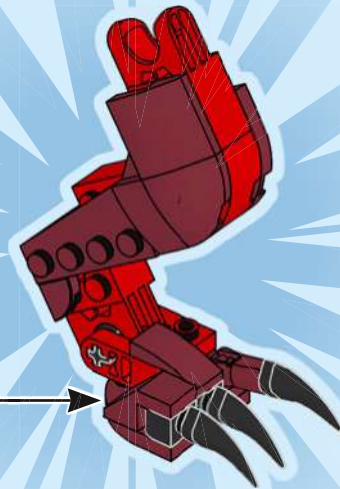

70

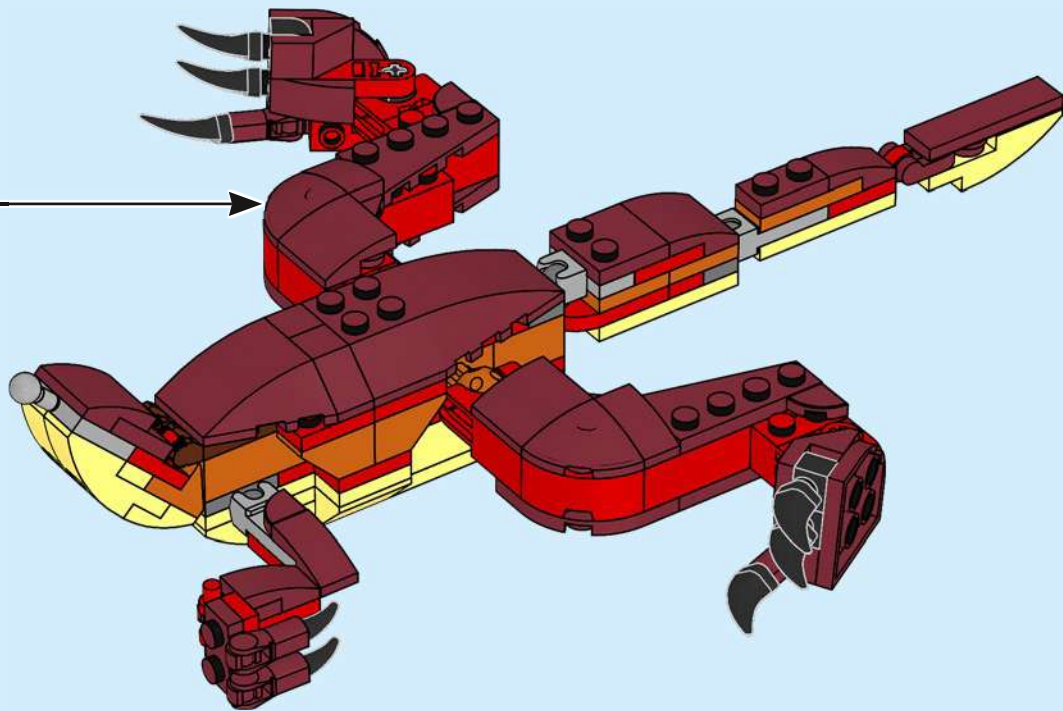

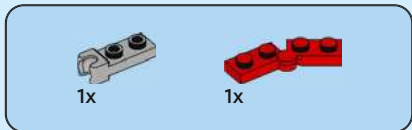

71

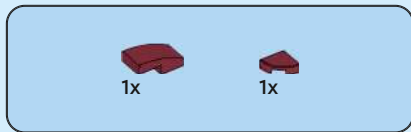
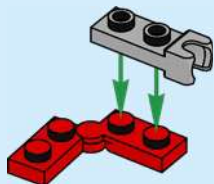

72

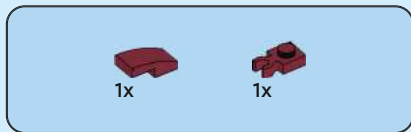
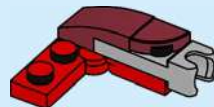

73

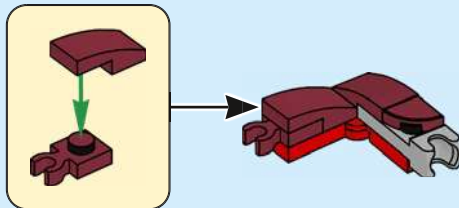



74

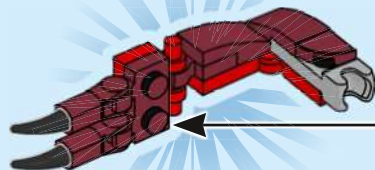
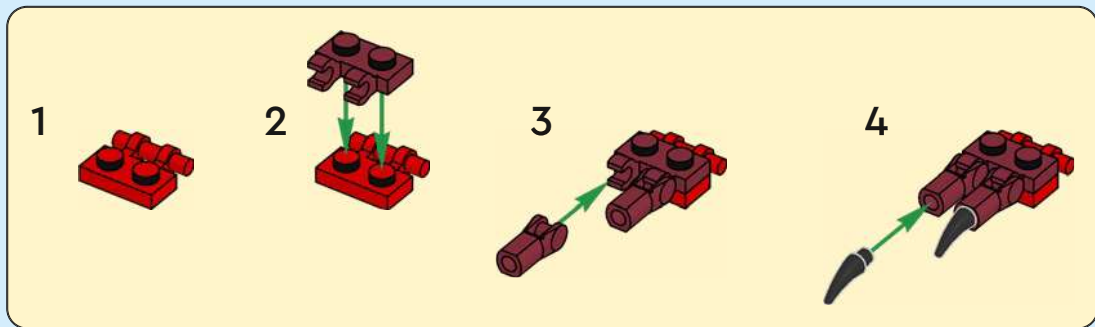

75

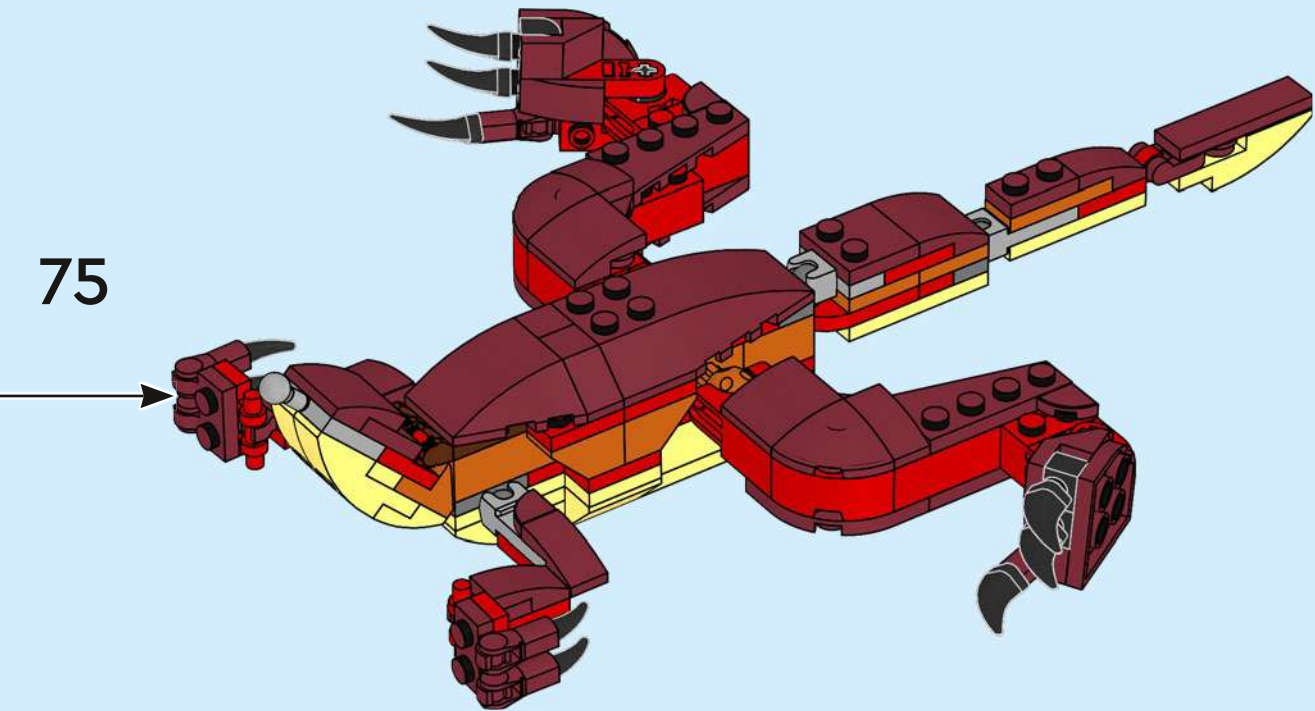



76





1x

77



1x

78



1x

79





1x



1x

80



1x



1x



1x

81

1



2

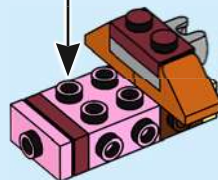



2x

82

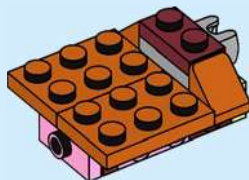

1x



1x



1x

83

1



2



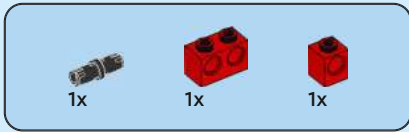

84

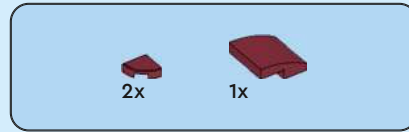
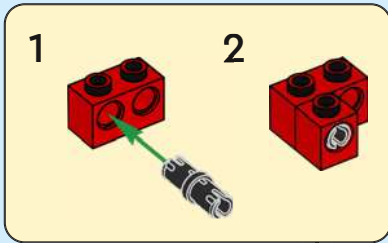

85





2x



2x

86

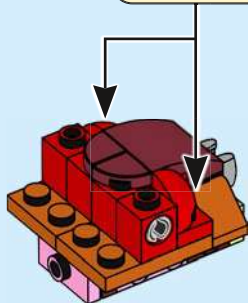
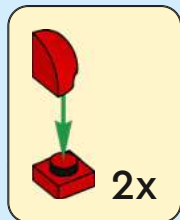

2x



1x

87





2x

90

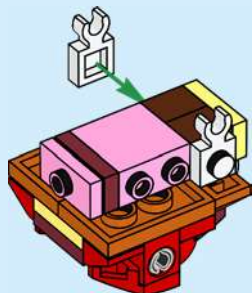

2x

91

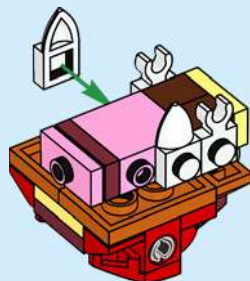



2x

92

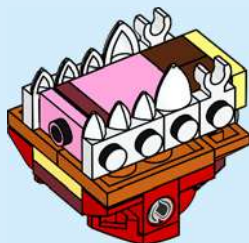

2x

93

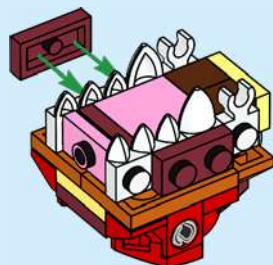



2x

94

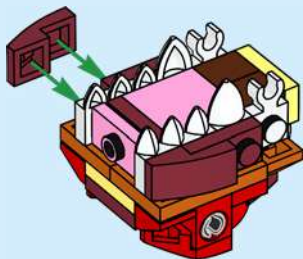

2x

95

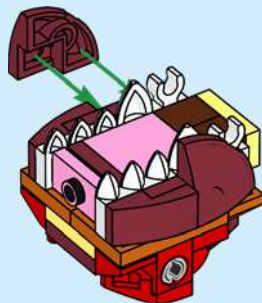



1x

96

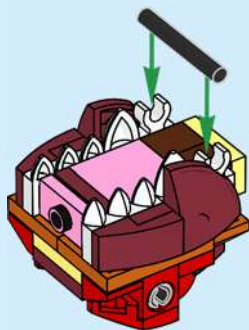

1x

97

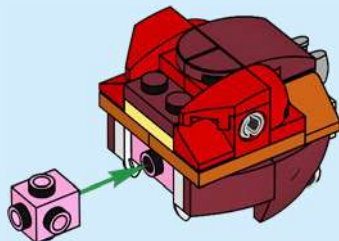
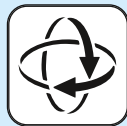



2x



2x



2x

98

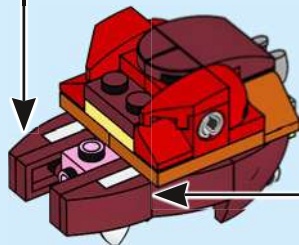
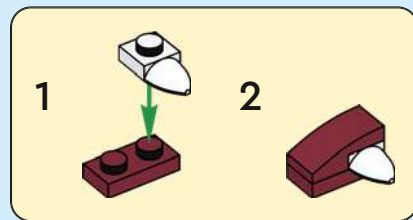
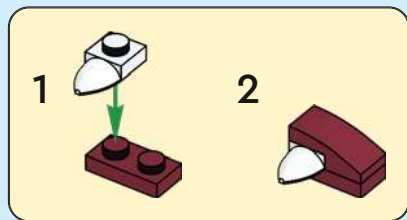

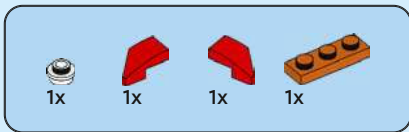

99

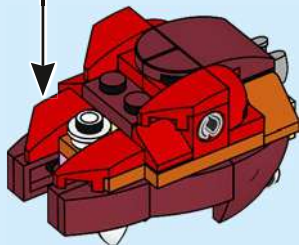
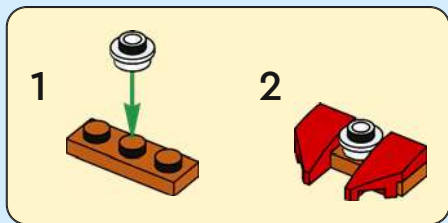

100

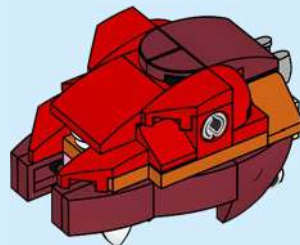



101

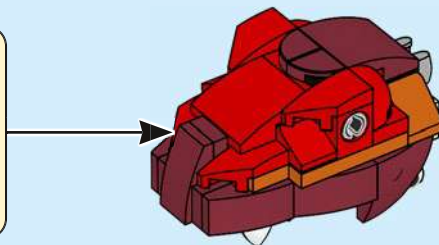
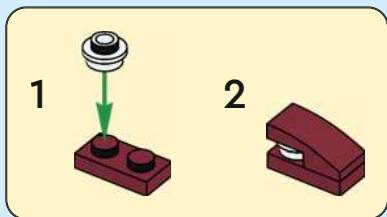

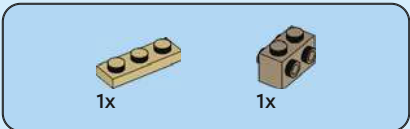

102

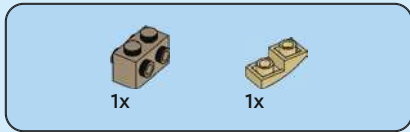
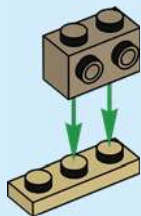

103

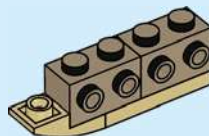



1x

104

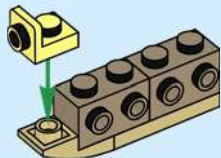

1x



1x

105





2x

106

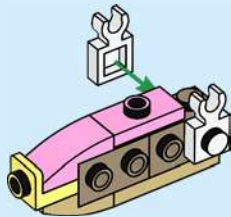

2x



2x

107





2x

108

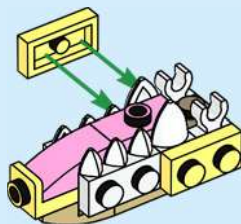

4x



2x

109

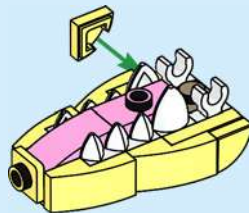

110

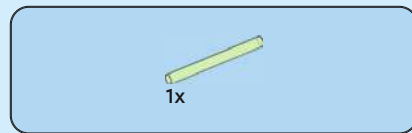
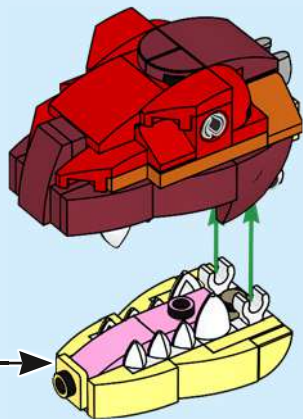

111

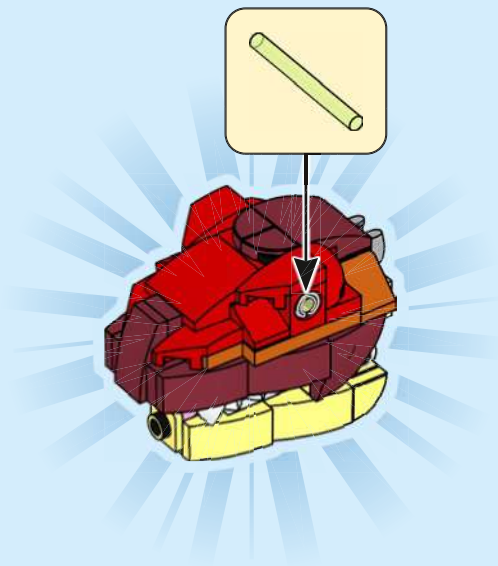

112

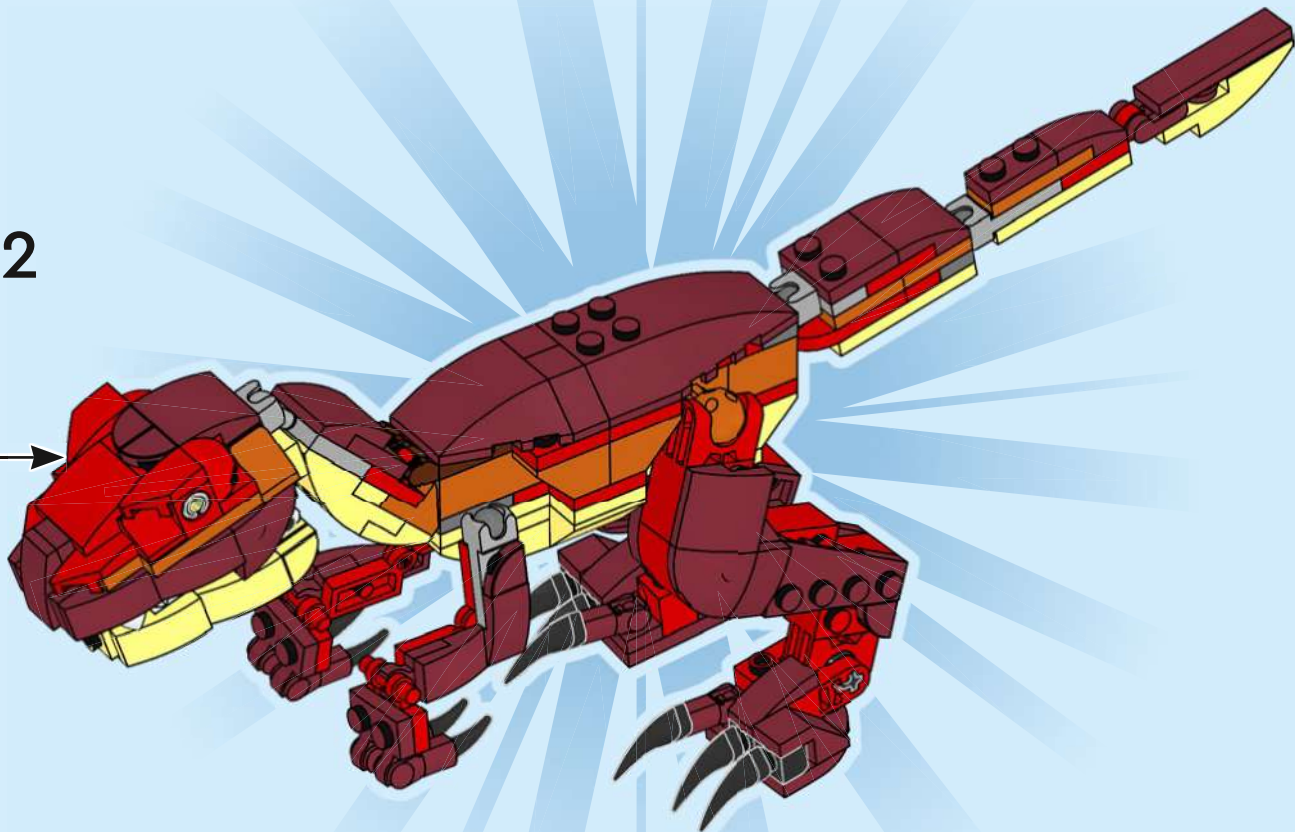

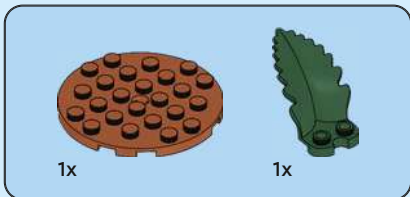
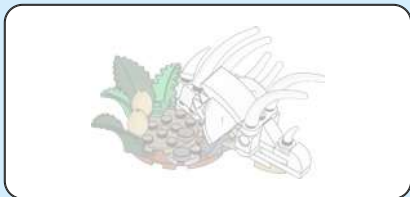

113

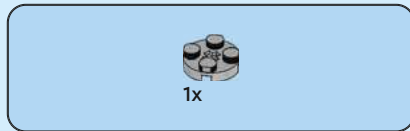
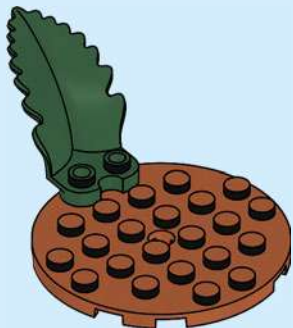

114

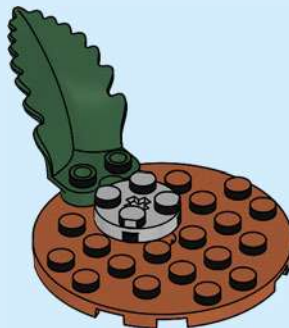



115

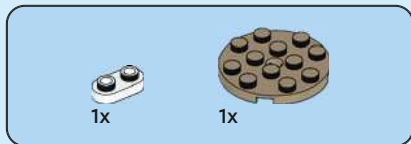
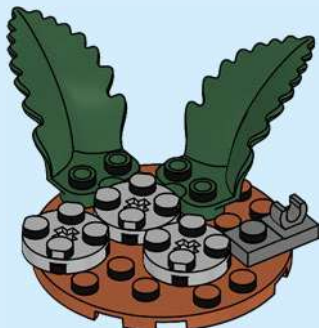

116



2x

117



1x



1x



1x

118

1

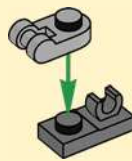

2

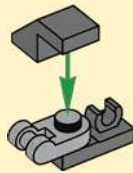

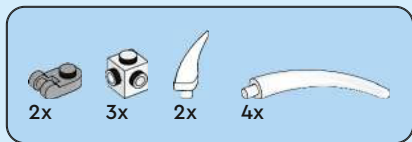

119

1

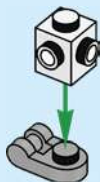

2



3

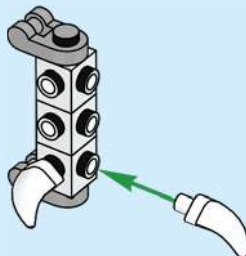

4

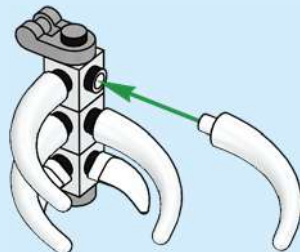

120

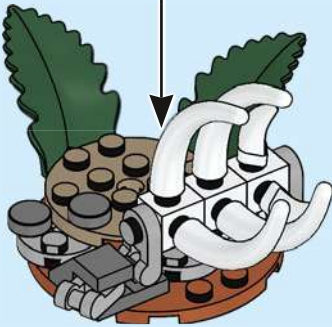



2x

121

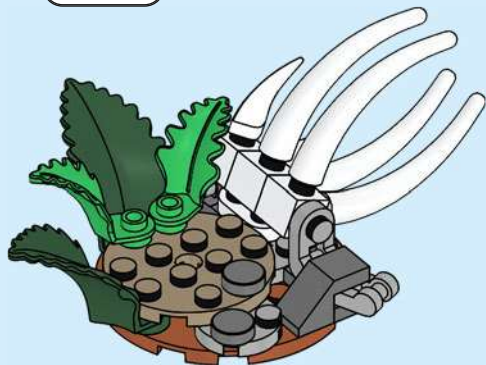

2x

122



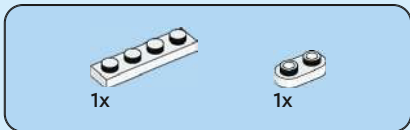

123

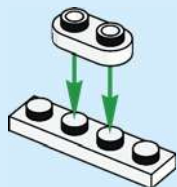

124





1x



1x

125

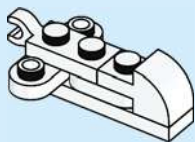

1x



1x

126

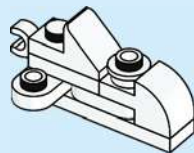



1x



2x

127

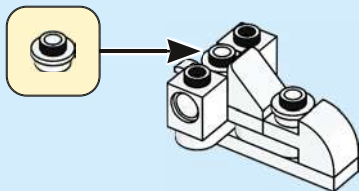

128



1x

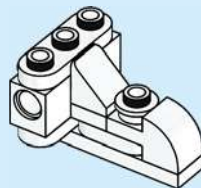



1x



1x

129

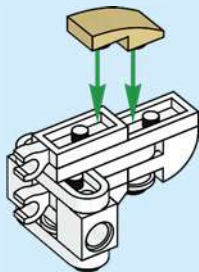

2x



1x

130

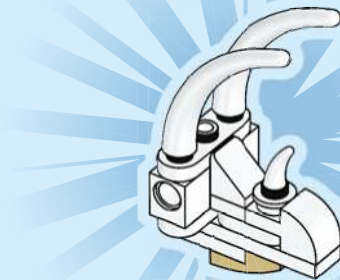

131

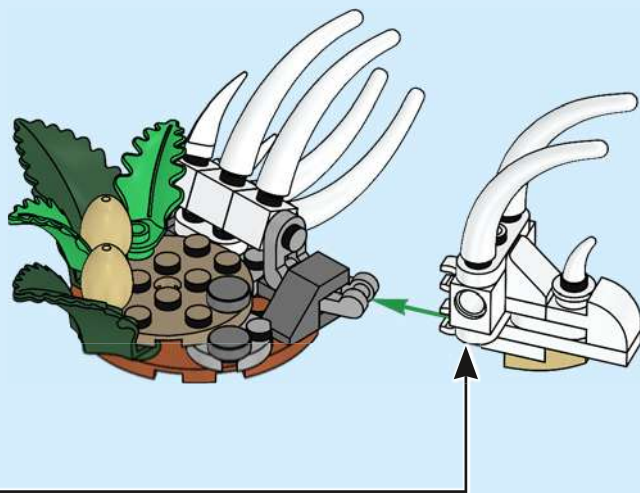

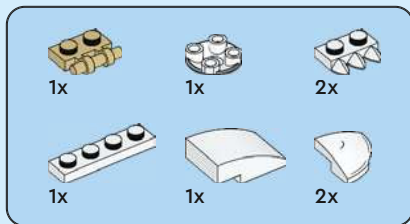

132

1

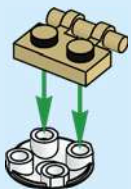

2

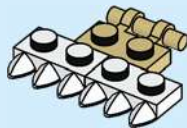

3

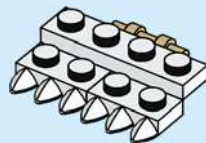

4

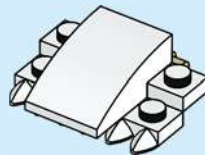

5



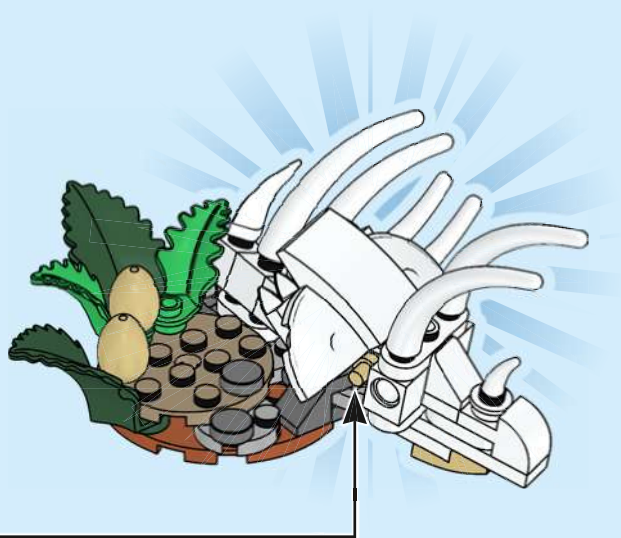





CREATOR™

3 IN 1

31385



31368



31380

31382





1x
6270106



4x
6168642



2x
6270092



2x
654101



3x
6224811



6x
4224792



2x
6210272



4x
6330191



1x
4278271



2x
6516468



1x
6519988



1x
6069002



6x
6046381



2x
6361170



2x
6450820



1x
6132212



2x
371001



6x
6110023



2x
6264077



2x
6251252



1x
4140593



1x
4121921



2x
654121



2x
4504379



2x
6177505



2x
302421



2x
6585072



2x
6177507



5x
302321



2x
6265697



2x
4179355



2x
4140585



1x
6346804



2x
242021



1x
6105976



2x
4567445



2x
6371957



1x
4188189



2x
300221



4x
6406930



2x
6416443



4x
302021



4x
6270103



4x
6424674



6x
6270091



2x
4286267



2x
4109810



2x
6279875



1x
6093525



2x
6581711



1x
6495165



2x
6135609



1x
6232138



2x
6507852



2x
6514057



6x
6337283



3x
6314247



6x
6311890

4x
6584054

4x
6147726

1x
6542265

3x
6225246

2x
6214309

2x
6008595

9x
4539097

2x
6360079

4x
6551406

1x
6585071

2x
6264994

3x
4211475

4x
6584062

2x
6008593

14x
6173168

4x
6544515

1x
6543345

5x
6584057

1x
6443844

2x
6043656

1x
6175314

2x
6008593

2x
6584061

2x
6359695

3x
6584053

1x
6248756

1x
6345505

3x
6043639

1x
6175314

4x
6267498

1x
4539060

1x
6483130

2x
6567216

4x
6296524

2x
6228969

1x
6448319

1x
6478887

2x
6210310

3x
6584052

1x
6373312

1x
6236034

2x
6284596

1x
6507884

5x
6107758

1x
6584055

9x
6201647

1x
6236034

1x
6168776

2x
6432734

2x
6546607

1x
6584060

1x
6424475

4x
6039479

2x
6452013



 [LEGO.com/service](https://www.LEGO.com/service)

YOU COULD
WIN



Scan this QR code or go to
LEGO.COM/PRODUCTFEEDBACK and give us
your short feedback about this LEGO® set
for a chance to win a cool LEGO prize.

Terms and Conditions apply*

EN: YOU COULD WIN. Terms and Conditions apply* **DE: Du könntest GEWINNEN.** Es gelten die Teilnahmebedingungen* **FR: Tu pourrais GAGNER.** Des conditions s'appliquent* **IT: Potresti VINCERE tu.** Termini e condizioni sono applicabili* **ES: Puedes GANAR.** Aplican términos y condiciones* **PT: PODERÁ GANHAR.** Aplicam-se Termos e Condições* **ZH: 轻松获奖.** 条款和条件适用* **PL: Szansa na WYGRANĄ.** Obowiązuje regulamin* **CS: Máte šanci VYHRÁT.** Platí všeobecné smluvní podmínky* **SK: Máte šancu VYHRAŤ.** Platia všeobecné zmluvné podmienky* **HU: TE IS NYERHETSZ.** Felhasználási feltételek érvényesek* **UA: ВИ МОЖЕТЕ ВИГРАТИ.** Застосовуються загальні положення та умови* **RO: Ai putea CÂȘTIGA.** Se aplică termeni și condiții* **BG: Можете да СПЕЧЕЛИТЕ.** Има определени правила и условия* **LV: Tu vari LAIMĒT.** Ir spēkā noteikumi un nosacījumi.* **ET: Sul on võimalus VÕITA.** Kehtivad tingimused* **LT: Jūs galite LAIMĖTI.** Taikomos sąlygos*

*[LEGO.com/productfeedback-terms](https://www.lego.com/productfeedback-terms)

LEGO and the LEGO logo are trademarks of the/son des marques de commerce du/son marcas registradas de LEGO Group.
©2026 The LEGO Group.



6616317