



Maintenance and Service Guide

HP OmniBook 5 16 inch Laptop Next Gen AI PC: Model Numbers: 16-bm0xxx and 16-bp0xxx

HP OmniBook 5 16 inch Laptop AI PC: Model Numbers: 16-bn1xxx and 16-cm0xxx

HP OmniBook 5 16 inch Laptop PC: Model Numbers: 16-bn0xxx and 16-br0xxx

SUMMARY

This guide provides maintenance information about such topics as spare parts, removal and replacement of parts, security, and backing up.

Legal information

© Copyright 2026 HP Development Company, L.P.

AMD, Ryzen, and Radeon are trademarks of Advanced Micro Devices, Inc. DTS is a registered trademark of DTS, Inc. Bluetooth is a trademark owned by its proprietor and used by HP Inc. under license. Chromebook, ChromeOS, and Google are trademarks of Google LLC. Intel, Core, Iris, and Thunderbolt are trademarks of Intel Corporation or its subsidiaries in the U.S. and/or other countries. Linux is a registered trademark of Linus Torvalds in the U.S. and other countries. Microsoft and Windows are either registered trademarks or trademarks of Microsoft Corporation in the United States and/or other countries. NVIDIA, GeForce RTX, Optimus, and Quadro are trademarks and/or registered trademarks of NVIDIA Corporation in the U.S. and other countries. SD is a trademark or registered trademark of SD-3C LLC. USB4, USB Type-C, and USB-C port logos are registered trademarks of USB Implementers Forum. DisplayPort and the DisplayPort logo are trademarks owned by the Video Electronics Standards Association (VESA) in the United States and other countries. Miracast and Wi-Fi are registered trademarks of Wi-Fi Alliance.

The information contained herein is subject to change without notice. The only warranties for HP products and services are set forth in the express warranty statements accompanying such products and services. Nothing herein should be construed as constituting an additional warranty. HP shall not be liable for technical or editorial errors or omissions contained herein.

First Edition: January 2026

Document Part Number: P74414-001

Product notice

This guide describes features that are common to most models. Some features may not be available on your computer.

Not all features are available in all editions or versions of Windows. Systems may require upgraded and/or separately purchased hardware, drivers, software or BIOS update to take full advantage of Windows functionality. Windows is automatically updated, which is always enabled. High-speed internet and Microsoft account required. ISP fees may apply and additional requirements may apply over time for updates. See <http://www.microsoft.com>.

If your product ships with Windows in S

Mode: Windows in S Mode works exclusively with apps from the Microsoft Store within Windows. Certain default settings, features, and apps cannot be changed. Some accessories and apps that are compatible with Windows may not work (including some antivirus, PDF writers, driver utilities, and accessibility apps), and performance may vary, even if you switch out of S Mode. If you switch to Windows, you cannot switch back to S Mode. Learn more at Windows.com/SmodeFAQ.

To access the latest user guides, go to <http://www.hp.com/support>, and follow the instructions to find your product. Then select **Setup & User Guides**.

Software terms

By installing, copying, downloading, or otherwise using any software product preinstalled on this computer, you agree to be bound by the terms of the HP End User License Agreement (EULA). If you do not accept these license terms, your sole remedy is to return the entire unused product (hardware and software) within 14 days for a full refund subject to the refund policy of your seller.

For any further information or to request a full refund of the price of the computer, please contact your seller.

Safety warning notice

Reduce the possibility of heat-related injuries or of overheating the computer by following the practices described.

-
- ⚠ WARNING!** To reduce the possibility of heat-related injuries or of overheating the mobile computer, do not place the mobile computer directly on your lap or obstruct the computer air vents. Use the mobile computer only on a hard, flat surface. Do not allow another hard surface, such as an adjoining optional printer; or a soft surface, such as pillows, rugs, or clothing, to block airflow. Also, do not allow the AC adapter to contact the skin or a soft surface, such as pillows or rugs or clothing, during operation. The computer and AC adapter provided by HP comply with the user-accessible surface temperature limits defined by applicable safety standards.
-

Important notice about Customer Self-Repair parts

Your computer includes Customer Self-Repair parts and parts that should be accessed only by an authorized service provider.



IMPORTANT: See [Removal and replacement procedures for Customer Self-Repair parts on page 30](#) for details.

Accessing parts described in [Removal and replacement procedures for authorized service provider parts on page 41](#) can damage the computer or void your warranty.

Table of contents

1 Product description	1
2 Components	5
Right side	5
Left side	6
Display	7
Low blue light mode (select products only)	7
Wake-on-voice (select products only)	7
Keyboard area	9
Touchpad settings and components	9
Touchpad settings	9
Touchpad components	9
Lights	10
Special keys	12
Bottom	13
Labels	14
3 Illustrated parts catalog	15
Computer major components	15
Display assembly subcomponents	18
Miscellaneous parts	20
4 Removal and replacement procedures preliminary requirements	22
Tools required	22
Service considerations	22
Plastic parts	22
Cables and connectors	22
Drive handling	22
Electrostatic discharge information	23
Generating static electricity	23
Preventing electrostatic damage to equipment	24
Personal grounding methods and equipment	24
Grounding the work area	25
Recommended materials and equipment	25
Cleaning your computer	26
Enabling HP Easy Clean (select products only)	26
Removing dirt and debris from your computer	26
Cleaning your computer with a disinfectant	27
Caring for wood veneer (select products only)	28
Packaging and transporting guidelines	28
Accessing support information	28

5 Removal and replacement procedures for Customer Self-Repair parts	30
Component replacement procedures	30
Preparation for disassembly.....	30
Bottom cover	30
Battery.....	33
Removing and reinstalling the same battery	33
Installing a new battery	35
6 Removal and replacement procedures for authorized service provider parts.....	41
Component replacement procedures	41
Speakers.....	41
Transition board.....	42
OLED power management board.....	43
Solid-state drive.....	44
WLAN module.....	45
Fan.....	47
USB board	48
Touchpad.....	49
Heat sink	51
System board	52
Display assembly.....	55
Keyboard with top cover	62
7 Troubleshooting guide	64
Resources	64
General troubleshooting steps.....	65
Identify the issue.....	65
1. Understand the issue	66
Startup sequence	66
Failure classification.....	66
2. Examine the environment.....	68
3. Perform a visual inspection of hardware.....	68
4. Update BIOS and drivers	69
Manually updating BIOS and drivers	69
Remotely deploying the BIOS and drivers	69
Analyze the issue.....	69
5. Remove or uninstall recently added hardware, software	69
6. HP Hardware Diagnostics and Tools.....	70
HP PC Hardware Diagnostics UEFI.....	70
HP BIOS Configuration Utility (BCU).....	71
HP Image Diagnostic Tool	72
HP Thermal Monitor.....	72
Non-HP diagnostics tools.....	72
7. Status lights, blinking light codes, troubleshooting lights, and POST error messages	72
Status lights	72
Blinking light codes	73
POST error messages	74
Resolve the issue.....	75

8. Hard reset.....	75
9. Soft reset (Default Settings).....	76
10. Reseat cables and connections.....	76
11. Test with minimum configuration.....	77
Essential hardware configuration.....	77
Safe mode.....	78
12. Test with verified working configuration (hardware or operating system).....	78
13. Replace the system board.....	78
Verify solution.....	79
Helpful Hints.....	80
At startup.....	80
During operation.....	80
Consulting with HP Service.....	81
Common issues and possible solutions.....	81
Power-on issues.....	81
No power.....	82
Intermittent power-on, shutdown, restart.....	84
AC adapter issue.....	85
Battery not recognized, not charging.....	85
Battery discharges too fast.....	88
Burnt smell.....	88
POST.....	89
No video (with power).....	89
Blinking lights.....	90
Diagnostic error messages.....	91
BIOS password.....	91
Performance (OS).....	92
Intermittent shutdown.....	92
Blue screen.....	93
Freeze at Windows Logo (hang or lockup).....	95
Electromagnetic Interference (EMI).....	96
No wake up.....	97
Unresponsive.....	98
Slow performance.....	99
HP Smart Adapter warning message.....	99
Incorrect time and date.....	100
Display.....	101
Display anomalies.....	101
Symptom.....	101
Quick check.....	102
HP PC Hardware Diagnostics (UEFI) for video test.....	102
Display assembly diagram.....	102
Dead pixel.....	103
No video (internal).....	103
No video (external).....	103
DisplayPort/VGA.....	104
HDMI.....	104
No or bad external video via docking.....	105

Incorrect or missing color/distorted image.....	105
Touch screen.....	106
I/O devices.....	107
Keyboard.....	107
Keyboard pointing stick (select products only).....	108
Keyboard backlight.....	109
Touchpad.....	109
Network connectivity (RJ-45 jack).....	110
Network connectivity wireless (WLAN).....	110
WWAN.....	111
USB.....	111
Smart card reader.....	112
Speaker, headphone - audio issues.....	113
Thunderbolt (TB).....	115
Storage.....	115
Hard drive or SSD not recognized.....	116
No boot to operating system (no read-write error).....	117
Read-write error.....	118
Slow performance.....	118
Blue screen (BSOD) error.....	119
Noisy hard drive.....	119
Mechanical.....	120
Noise (sound).....	120
Fan runs constantly.....	121
Thermal shutdown (hot).....	122
Additional information.....	122
Acronyms.....	123
Blinking lights and startup error codes.....	123
Processor not executing code.....	124
BIOS recovery code unable to find valid BIOS recovery image.....	124
Memory module error.....	124
Graphics Controller Error (No Controller).....	125
Failure System Board Error.....	125
Intel Trusted Execution Technology (TXT) Error.....	125
Sure Start unable to find valid BIOS Boot Block image.....	125
Sure Start has identified a problem (Manual Recovery Policy Set).....	126
POST error messages and user actions.....	126
Routine maintenance for performance improvement.....	127
Common blue screen error messages.....	128
Error message list.....	128
Bug check symbolic names.....	128
Microsoft general troubleshooting of Windows bug check codes.....	128
Use Windows Debugging Tool.....	129
Windows Software Development Kit (SDK).....	129
Display issue: pixel anomalies.....	133
Cable management.....	134
Connector types.....	135
Flex cable.....	135

Horizontal cable insertion.....	136
Multiple-pin horizontal connector (LVDS cable to display panel).....	136
Multiple-pin vertical connector (LVDS cable to system board).....	136
8 Using Setup Utility (BIOS).....	138
Starting Setup Utility (BIOS).....	138
Updating Setup Utility (BIOS).....	138
Determining the BIOS version.....	138
Preparing for a BIOS update.....	139
Downloading a BIOS update.....	139
Installing a BIOS update.....	140
9 Computer Setup (BIOS), TPM, and HP Sure Start.....	141
Using Computer Setup.....	141
Navigating and selecting in Computer Setup.....	141
Restoring factory settings in Computer Setup.....	141
Updating the BIOS.....	142
Determining the BIOS version.....	142
Preparing for a BIOS update.....	142
Downloading a BIOS update.....	143
Installing a BIOS update.....	143
Changing the boot order using the f9 prompt.....	144
TPM BIOS settings (select products only).....	144
Using HP Sure Start (select products only).....	144
10 Backing up, resetting, and recovering.....	145
Backing up.....	145
Resetting.....	145
Recovering.....	145
Installing the Chromebook Recovery Utility.....	146
Creating recovery media.....	146
Recovering the Chrome operating system.....	146
Setting up your computer after a reset or recovery.....	147
Erase and reformat the recovery media.....	147
11 Backing up, restoring, and recovering.....	148
Backing up information and creating recovery media.....	148
Using Windows tools for backing up.....	148
Using the HP Cloud Recovery Download Tool to create a recovery USB flash drive (select products only).....	148
Restoring and recovering your system.....	148
Creating a system restore.....	149
Restoring and recovery methods.....	149
Recovering using the HP Recovery USB flash drive.....	149
Changing the computer boot order.....	150
Using HP Sure Recover (select products only).....	150

12 Using HP PC Hardware Diagnostics	151
Using HP PC Hardware Diagnostics Windows (select products only).....	151
Using an HP PC Hardware Diagnostics Windows hardware failure ID code.....	151
Accessing HP PC Hardware Diagnostics Windows.....	151
Accessing HP PC Hardware Diagnostics Windows from HP Support Assistant (select products only)	151
Accessing HP PC Hardware Diagnostics Windows from the Start menu (select products only).....	152
Downloading HP PC Hardware Diagnostics Windows.....	152
Downloading the latest HP PC Hardware Diagnostics Windows version from HP	152
Downloading the HP PC Hardware Diagnostics Windows from the Microsoft Store	152
Downloading HP Hardware Diagnostics Windows by product name or number (select products only)	153
Installing HP PC Hardware Diagnostics Windows.....	153
Using HP PC Hardware Diagnostics UEFI	153
Using an HP PC Hardware Diagnostics UEFI hardware failure ID code	153
Starting HP PC Hardware Diagnostics UEFI.....	153
Starting HP PC Hardware Diagnostics UEFI through HP Hotkey Support software (select products only).....	154
Downloading HP PC Hardware Diagnostics UEFI to a USB flash drive.....	154
Downloading the latest HP PC Hardware Diagnostics UEFI version.....	155
Downloading HP PC Hardware Diagnostics UEFI by product name or number (select products only)	155
Using Remote HP PC Hardware Diagnostics UEFI settings (select products only).....	155
Downloading Remote HP PC Hardware Diagnostics UEFI	155
Downloading the latest Remote HP PC Hardware Diagnostics UEFI version.....	155
Downloading Remote HP PC Hardware Diagnostics UEFI by product name or number	156
Customizing Remote HP PC Hardware Diagnostics UEFI settings.....	156
13 Specifications	157
Computer specifications	157
Display specifications.....	158
Solid-state drive specifications	158
14 Power cord set requirements	160
Requirements for all countries	160
Requirements for specific countries and regions	160
15 Swelling or deformation of notebook battery	163
Swollen notebook batteries	163
Swollen battery is not a safety issue	163
Discontinue using a swollen battery	163
Replace a swollen battery	163
Minimize battery swelling.....	163
Adaptive Battery Optimizer (consumer notebooks).....	164
HP Battery Health Manager (commercial notebooks).....	164
16 Recycling	165

1 Product description

This table provides detailed product information.



NOTE: For the latest specifications related to your computer, go to <http://www.hp.com/support> and follow the instructions to find your product. Select **Specifications & Accessories**, select **Product information**, and then select the specifications link.

Table 1-1 Product components and their descriptions

Category	Description	
Product Name	HP OmniBook 5 16 inch Laptop Next Gen AI PC AMD® model numbers: 16-bp0xxx Intel® model numbers: 16-bm0xxx	
	HP OmniBook 5 16 inch Laptop AI PC AMD model numbers: 16-br0xxx Intel model numbers: 16-bn1xxx	
	HP OmniBook 5 16 inch Laptop PC AMD model numbers: 16-cm0xxx Intel model numbers: 16-bn0xxx	
Processors	AMD Ryzen™ processors AMD Ryzen AI 9 465 AMD Ryzen AI 7 445 AMD Ryzen AI 5 430 AMD Ryzen 7 250 AMD Ryzen 5 230	
	Intel Core™ processors Intel Core Ultra 9 processor Intel Core Ultra 7 processor Intel Core Ultra 5 processor Intel Core i7 processor Intel Core i5 processor	
	Graphics	Intel graphics Intel ARC Graphics Intel Graphics Intel Iris Xe Intel UHD Graphics

Table 1-1 Product components and their descriptions (continued)

Category	Description
	Supports HD decode, DX12, and HDMI
	AMD graphics
	AMD Radeon™ 840M
	AMD Radeon 780M
	AMD Radeon 760M
	AMD Radeon Integrated Graphics
Display	40.6 cm (16 in), narrow bezel, widescreen ultra extended graphics array (WUXGA)
	2.8K (2880 × 1800), antiglare, OLED, flat (3.2 mm), 45% NTSC, embedded DisplayPort™ (eDP) 1.5, 500 nits, 120 Hz (variable rate refresh [VRR])
	Full high definition (FHD) (1920 × 1200), touchscreen, antiglare, OLED, flat (3.2 mm), 45% NTSC, embedded DisplayPort (eDP) 1.2, 300 nits, 60 Hz (variable rate refresh [VRR])
	Full high definition (FHD) (1920 × 1200), non-touchscreen, antiglare, OLED, flat (3.2 mm), 45% NTSC, embedded DisplayPort (eDP) 1.2, 300 nits, 60 Hz (variable rate refresh [VRR])
	Organic light-emitting diode (OLED)
	Low-voltage differential signaling (LVDS)
	HD
	Touch-on panel (TOP)
	Microsoft HDR streaming capable
Memory	One memory module supporting up to 16 or 32 GB of RAM
	DDR5-7500 dual-channel support
	Low-power double data rate (LPDDR)
	Supports the following configurations:
	<ul style="list-style-type: none"> • 32 GB (32 × 1) • 16 GB (16 × 1)
Primary storage	PCIe, (Non-Volatile Memory Express) NVMe, M.2 2280 solid-state drives (SSDs)
	<ul style="list-style-type: none"> • 1 TB, PCIe, triple layer cell (TLC) • 512 GB, PCIe, TLC
Audio and video	Audio brand: HP Audio
	Support for DTS:X® Ultra
	HP FHD Camera: indicator LED, USB 2.0, f2.0, high dynamic range (HDR)
	720p by 30 frames per second
	Dual-array digital microphone with appropriate software: beam forming, echo cancellation, noise suppression
	Camera privacy cover
Wireless	Wireless Local Area Network (WLAN)

Table 1-1 Product components and their descriptions (continued)

Category	Description
	Intel Wi-Fi® 7 R2 Be211 + Bluetooth® 6 multiple input, multiple output (MU-MIMO), supporting gigabit file transfer speeds
	Realtek Wi-Fi 7 + Bluetooth 6 WLAN
	Realtek 8852BE-VT Wi-Fi 6 Bluetooth 5.4 WLAN
	Compatible with Miracast® devices
Ports	Hot plug/unplug and autodetect for correct output to wide-aspect vs. standard aspect video
	HDMI v2.1 supporting: up to 4096 × 2160 @ 60 Hz with HDCP 2.2
	Audio-out (headphone)/audio-in (microphone) combo jack
	USB 3.2 Gen 2 Type C® with Thunderbolt™ Gen 4 technology (left side)
	USB 3.2 Gen 2 Type A (supports HP Sleep & Charge; right side)
	USB 3.2 Gen 1 Type A (supports HP Sleep & Charge; left side)
	USB4 Type-C Thunderbolt 4, supports: <ul style="list-style-type: none">- DisplayPort 1.4 out up to 8 K @ 60 Hz and HDMI 2.1 out with adapter- Power delivery (100 W input [20 V @ 5A and 20 V @ 3.25A])- Data transfer- HDMI 2.1 output up to 8 K @ 60 Hz with HDCP 2.3 with adapter capable of HDMI 2.1- HP Sleep & Charge
Keyboard/pointing devices	Keyboard
	Full size, backlit, 3-coat paint, island style
	Touchpad
	Multitouch gestures enabled
	Precision touchpad support
	Support for Modern Trackpad Gestures
	Taps enabled as default
Power requirements	Battery
	4 cell, 68 Whr, polymer, HP Long Life
	HP Fast Charge Technology
	Smart AC adapters
	65 W, USB Type-C®
	Power cord
	C5, 2 m (6.6 ft)
	Non-Power Factor Correction (nPFC) or Power Factor Correction (PFC)
Security	Supports firmware-based Trusted Platform Module (TPM) 2.0
	Microphone mute

Table 1-1 Product components and their descriptions (continued)

Category	Description
	Camera privacy cover
Operating system	Windows® 11 Home 64 NextGen Premium
	Windows 11 Home 64 NextGen Standard
	Windows 11 Pro 64 NextGen Premium
	Windows 11 Pro 64 NextGen Standard
	Windows 11 Home 64 NextGen Premium Single Language Africa Market PPP
	Windows 11 Home 64 NextGen Standard Single Language Africa Market PPP
	Windows 11 Home 64 NextGen Premium Single Language APAC EM PPP
	Windows 11 Home 64 NextGen Standard Single Language APAC EM PPP
	Windows 11 Home 64 NextGen Premium Chinese Market CPPP
	Windows 11 Home 64 NextGen Standard Chinese Market CPPP
	Windows 11 Home 64 NextGen Premium Single Language India Market PPP
	Windows 11 Home 64 NextGen Standard Single Language India Market PPP
	Windows 11 Home 64 NextGen Premium Single Language Indonesia Market PPP
	Windows 11 Home 64 NextGen Standard Single Language Indonesia Market PPP
Serviceability	End user replaceable parts
	AC adapter
	Bottom cover
	Battery

2 Components



Your computer features top-rated components. This chapter provides details about your components, where they are located, and how they work.

Right side

Use this illustration and table to identify the components on the right side of the computer.



Table 2-1 Right-side components and their descriptions

	Component	Description
(1) 	Audio-out (headphone)/Audio-in (microphone) combo jack	<p>Connects optional powered stereo speakers, headphones, earbuds, a headset, or a television audio cable. Also connects an optional headset microphone. This jack does not support optional standalone microphones.</p> <p>WARNING! To reduce the risk of personal injury, adjust the volume before putting on headphones, earbuds, or a headset. For additional safety information, see the <i>Regulatory, Safety, and Environmental Notices</i>.</p> <p>To access this guide:</p> <ul style="list-style-type: none">■ Select the Search icon in the taskbar, type HP Documentation in the search box, and then select HP Documentation. <p>NOTE: When a device is connected to the jack, the computer speakers are disabled.</p>
(2) 	USB port	<p>Connects a USB device, provides data transfer, and (for select products) charges small devices (such as a smartphone) when the computer is on or in sleep mode.</p> <p>NOTE: Use a standard USB Type-A charging cable or cable adapter (purchased separately) when charging a small external device.</p>

Left side

Use this illustration and table to identify the components on the left side of the computer.



NOTE: Images shown may vary from your actual product image.

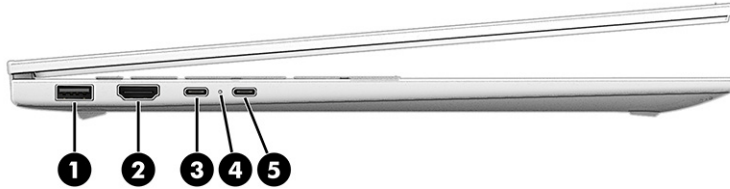

Table 2-2 Left-side components and their descriptions



	Component	Description
(1)	 USB port	Connects a USB device, provides data transfer, and (for select products) charges small devices (such as a smartphone) when the computer is on or in Sleep mode. NOTE: Use a standard USB Type-A charging cable or cable adapter (purchased separately) when charging a small external device.
(2)	 HDMI port	Connects an optional video or audio device, such as a high-definition television, any compatible digital or audio component, or a high-speed High-Definition Multimedia Interface (HDMI) device.
(3)	USB Type-C power connector and Thunderbolt port (select models only) with HP Sleep and Charge and DisplayPort output	Connects an AC adapter that has a USB Type-C connector, supplying power to the computer and, if needed, charging the computer battery. - and - Connects a USB device, provides high-speed data transfer, and charges small devices (such as a smartphone), even when the computer is off. NOTE: Use a standard USB Type-C charging cable or cable adapter (purchased separately) when charging a small external device. - and - Connects a display device that has a USB Type-C connector, providing DisplayPort output. NOTE: Your computer might also support a Thunderbolt docking station.

Table 2-2 Left-side components and their descriptions (continued)

	Component	Description
(4)	AC adapter and battery light	<ul style="list-style-type: none">• White: The AC adapter is connected and the battery is fully charged.• Blinking amber: The AC adapter is disconnected and the battery has reached a low battery level.• Amber: The AC adapter is connected and the battery is charging.• Off: The battery is not charging.
(5)	USB Type-C power connector and Thunderbolt port (select models only) with HP Sleep and Charge and DisplayPort output (select models)	<p>Connects an AC adapter that has a USB Type-C connector, supplying power to the computer and, if needed, charging the computer battery.</p> <p>- and -</p> <p>Connects a USB device, provides high-speed data transfer, and charges small devices (such as a smartphone), even when the computer is off.</p> <p>NOTE: Use a standard USB Type-C charging cable or cable adapter (purchased separately) when charging a small external device.</p> <p>- and -</p> <p>Connects a display device that has a USB Type-C connector, providing DisplayPort output.</p> <p>NOTE: Your computer might also support a Thunderbolt docking station.</p>

Display

The computer display can include essential components such as speakers, antennas, cameras, and microphones.

Low blue light mode (select products only)

Your computer display is shipped from the factory in low blue light mode for improved eye comfort and safety. Also, blue light mode automatically adjusts blue light emissions when you are using the computer at night or for reading.

⚠ WARNING! To reduce the risk of serious injury, read the *Safety & Comfort Guide*. It describes proper workstation setup and proper posture, health, and work habits for computer users. The *Safety & Comfort Guide* also provides important electrical and mechanical safety information. The *Safety & Comfort Guide* is available on the web at <http://www.hp.com/ergo>.

Wake-on-voice (select products only)

Use the wake-on-voice feature to wake or interact with your computer quickly.

To access the wake-on-voice settings, follow these steps:

1. Select the **Search** icon in the taskbar, type *Xiaowei* in the search box, and then select **Xiaowei**.

2. When the tool opens, scan the QR code with your mobile device, which takes you to the settings page, where you can select your wake-on-voice features.
3. Follow the on-screen instructions.

 **NOTE:** Allow the Xiaowei app to continue running on the computer.

Use this illustration and table to identify components on the display.

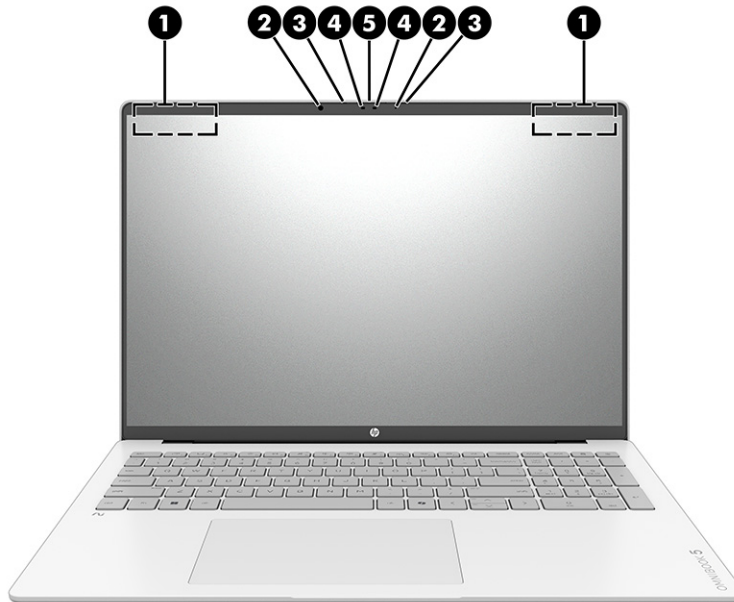

Table 2-3 Display components and their descriptions

	Component	Description
(1)	WLAN antennas*	Send and receive wireless signals to communicate with wireless local area networks (WLANs).
(2)	Camera lights (2)	On: One or more cameras are in use.
(3)	Internal microphones (2)	Record sound.
(4)	Cameras (2)	Allow you to video chat, record video, and record still images. Some cameras also allow a facial recognition logon to Windows, instead of a password logon. NOTE: Camera functions vary depending on the camera hardware and software installed on your product.
(5)	Camera privacy cover	By default, the camera lens is uncovered, but you can slide the camera privacy cover to block the camera's view. To use the camera, slide the camera privacy cover in the opposite direction to reveal the lens.

*The antennas are not visible from the outside of the computer. For optimal transmission, keep the areas immediately around the antennas free from obstructions.

For wireless regulatory notices, see the section of the *Regulatory, Safety, and Environmental Notices* that applies to your country or region.

To access this guide:

- Select the **Search** icon in the taskbar, type `HP Documentation` in the search box, and then select **HP Documentation**.

Keyboard area

Keyboards can vary by language.



NOTE: The keyboard area, including the function keys and (select products only) power key, is disabled in stand, tent, and tablet modes. To enable the keyboard, including the power key, change to the clamshell mode.

Touchpad settings and components

Learn the touchpad settings and components.

Touchpad settings

Learn how to adjust touchpad settings.

Adjusting touchpad settings

Use these steps to adjust touchpad settings and gestures.

1. Select the **Search** icon in the taskbar, type `touchpad settings` in the search box, and then press `enter`.
2. Choose a setting.

Turning on the touchpad

Follow these steps to turn on the touchpad.

1. Select the **Search** icon in the taskbar, type `touchpad settings` in the search box, and then press `enter`.
2. Using an external mouse, click the **touchpad** button.

If you are not using an external mouse, press the `Tab` key repeatedly until the pointer rests on the **touchpad** button. Then press the `spacebar` to select the button.

Touchpad components

Use this illustration and table to identify the touchpad components.

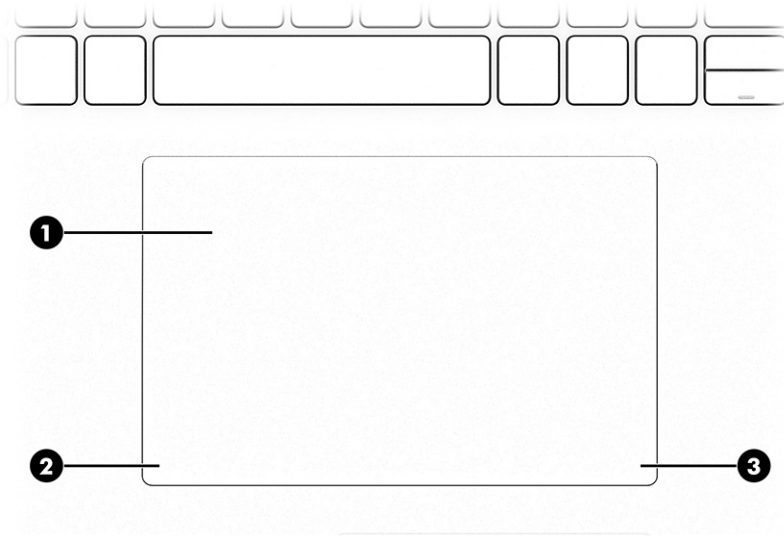

Table 2-4 Touchpad components and their descriptions

	Component	Description
(1)	Touchpad zone	Reads your finger gestures to move the pointer or activate items on the screen.
(2)	Left touchpad button	Functions like the left button on an external mouse.
(3)	Right touchpad button	Functions like the right button on an external mouse.

Lights

Use this illustration and table to identify the lights on the computer.

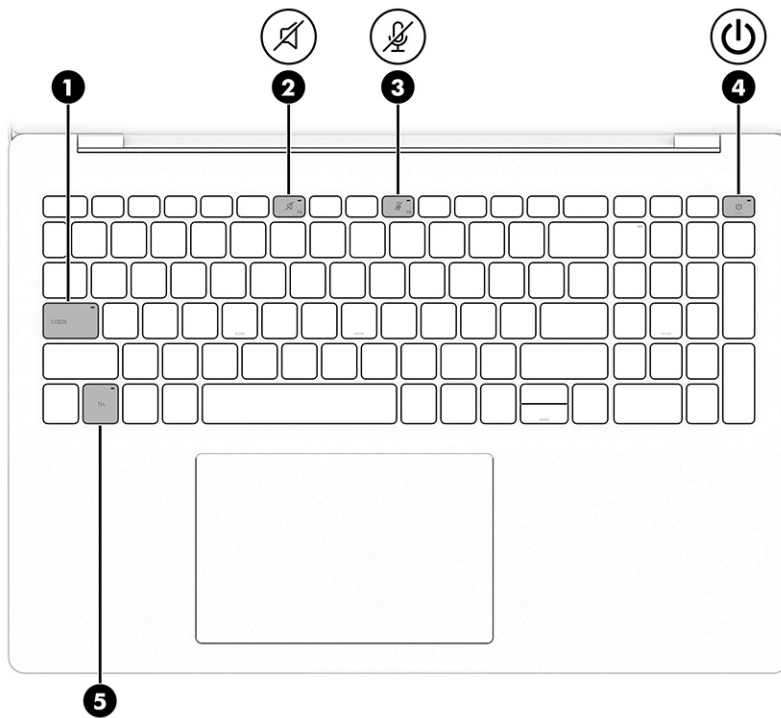





Table 2-5 Lights and their descriptions

	Component	Description
(1)	Caps lock light	On: Caps lock is on, which switches the key input to all capital letters.
(2)	 Mute light	<ul style="list-style-type: none"> On: Computer sound is off. Off: Computer sound is on.
(3)	 Microphone mute light	<ul style="list-style-type: none"> On: Microphone is off. Off: Microphone is on.
(4)	 Power light	<ul style="list-style-type: none"> On: The computer is on. Blinking (select products only): The computer is in the Sleep state, a power-saving state. The computer shuts off power to the display and other unnecessary components. Off: Depending on your computer model, the computer is off, in Hibernation, or in Sleep. Hibernation is the power-saving state that uses the least amount of power.
(5)	Fn lock light	<ul style="list-style-type: none"> On: FN Lock is enabled. Off: FN Lock is disabled. <p>NOTE: On some products, FN Lock is assigned as the secondary function of the left Shift key. To enable FN Lock, press fn + left Shift. Repeat the same key combination again to disable FN Lock.</p>

Special keys

Use this illustration to identify the special keys.

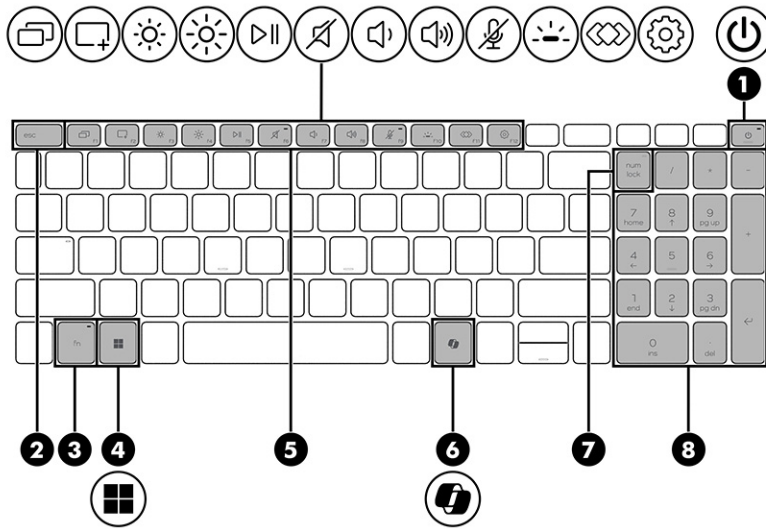

Table 2-6 Special keys and their descriptions



	Component	Description
<p>(1)</p> 	<p>Power button</p>	<ul style="list-style-type: none"> • When the computer is off, press the button briefly to turn on the computer. • When the computer is on, press the button briefly to initiate sleep. • When the computer is in the sleep state, press the button briefly to exit sleep (select products only). • When the computer is in hibernation, press the button briefly to exit hibernation. <p>IMPORTANT: Pressing and holding down the power button results in the loss of unsaved information.</p> <p>If the computer has stopped responding and shutdown procedures are ineffective, press and hold the power button down for at least 10 seconds to turn off the computer.</p> <p>To learn more about your power and sleep settings:</p> <ul style="list-style-type: none"> ■ Right-click the Power icon , and then select Power and sleep settings.
<p>(2)</p>	<p>esc key</p>	<p>Displays system information when pressed in combination with the fn key.</p>
<p>(3)</p>	<p>fn key</p>	<p>Executes specific functions when pressed in combination with another key.</p> <p>NOTE: When using combination shortcut keys, the order in which keys are pressed may affect the result.</p>

Table 2-6 Special keys and their descriptions (continued)

	Component	Description
(4)	Windows key	Opens the Start menu. NOTE: Pressing the Windows key again will close the Start menu.
(5)	Action keys	Execute frequently used system functions as defined by the icon symbols on f1 through f12 function keys.
(6)	Windows Copilot key 	Opens Windows Copilot (select products only). NOTE: Copilot in Windows (select products only) requires Windows 11. Some features require a neural processing unit (NPU). The timing of feature delivery and availability varies by market and device. You must have a Microsoft account to use the Copilot feature. When the Copilot feature is not available, pressing the Copilot key opens the Bing search engine. See http://aka.ms/WindowsAIFeatures .
(7)	num lock key	Alternates between the navigational and numeric functions on the integrated numeric keypad.
(8)	Integrated numeric keypad	A separate keypad to the right of the alphabet keyboard. When num lock is pressed, the keypad can be used like an external numeric keypad. NOTE: If the keypad function is active when the computer is turned off, that function is reinstated when the computer is turned back on.

Bottom

Identify the bottom components.

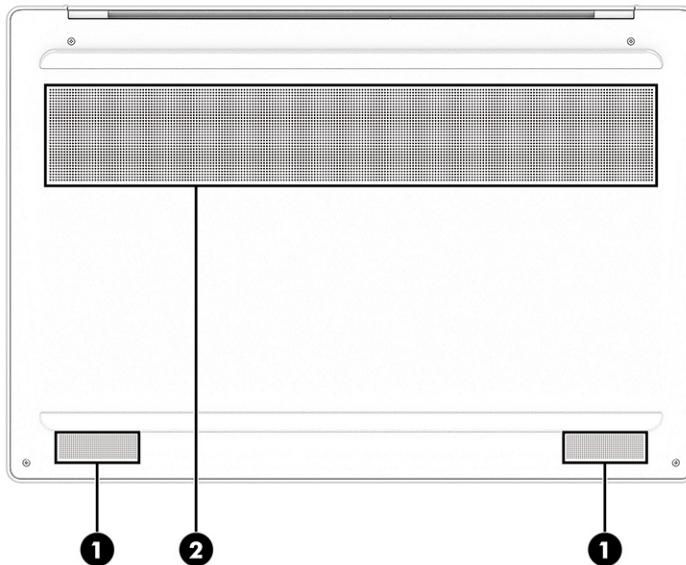

Table 2-7 Bottom components and their descriptions

	Component	Description
(1)	Speakers (2)	Produce sound.

Table 2-7 Bottom components and their descriptions (continued)

	Component	Description
(2)	Vent	Enables airflow to cool internal components. NOTE: The computer fan starts up automatically to cool internal components and prevent overheating. It is normal for the internal fan to cycle on and off during routine operation.

Labels

The labels affixed to the computer provide information that you might need when you troubleshoot system problems or travel internationally with the computer. Labels can be in paper form or imprinted on the product.

 **IMPORTANT:** Check the following locations for the labels described in this section: the bottom of the computer, inside the battery bay, under the service door, on the back of the display, or on the bottom of a tablet kickstand.

- Service label—Provides important information to identify your computer. When contacting support, you might be asked for the serial number, the product number, or the model number. Locate this information before you contact support.

Your service label will resemble the following example:

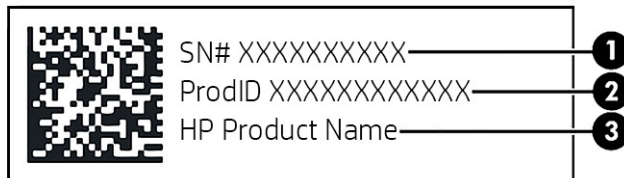

Table 2-8 Service label components

Component
(1) Serial number
(2) Product ID
(3) HP product name and model number

- Regulatory labels—Provide regulatory information about the computer.
- Wireless certification labels—Provide information about optional wireless devices and the approval markings for the countries or regions in which the devices have been approved for use.

3 Illustrated parts catalog

Use this chapter to determine the spare parts that are available for the computer.

Computer major components

Use this illustration and table to identify the computer major components.

 **NOTE:** HP continually improves and changes product parts. For complete and current information about supported parts for your computer, go to <http://partsurfer.hp.com>, select your country or region, and then follow the on-screen instructions.

 **NOTE:** Details about your computer, including model, serial number, product key, and length of warranty, are on the service tag at the bottom of your computer.

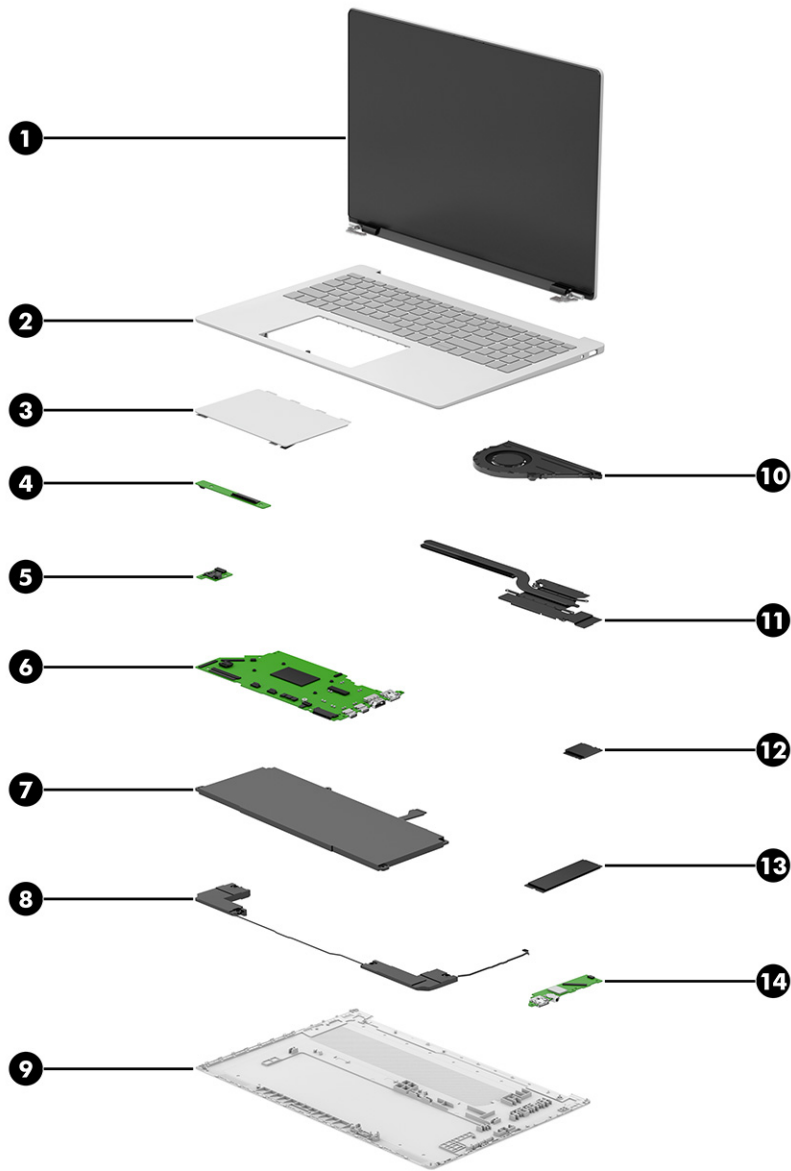

Table 3-1 Computer major component descriptions and part numbers

Item	Component	Spare part number
(1)	Display assembly NOTE: Display spare parts are available only as subcomponents. For spare part information, see Display assembly subcomponents on page 18 .	
(2)	Top cover with keyboard NOTE: For a detailed list of country codes, see Keyboard with top cover on page 62 .	
	Glacier silver	P83599-001
	Meteor silver	P83600-001
	Silk sand	P83601-001
	Starlit blue	P83602-001

Table 3-1 Computer major component descriptions and part numbers (continued)

Item	Component	Spare part number
(3)	Touchpad	
	Glacier silver	P83628-001
	Meteor silver	P83629-001
	Silk sand	P83630-001
	Starlit blue	P83631-001
(4)	Transition board (with cable)	P83617-001
(5)	Power management board	P83616-001
(6)	System board for use in models with an AMD processor (includes integrated processor, the Windows operating system, and either 32 or 16 Gb of integrated memory)	
	AMD Ryzen AI 9 465(32 GB)	P83638-601
	AMD Ryzen AI 9 465 (32 GB, People's Republic of China)	P83643-601
	AMD Ryzen AI 7 445 (32 GB)	P83637-601
	AMD Ryzen AI 7 445 (32 GB, PRC)	P83642-601
	AMD Ryzen AI 7 445 (16 GB)	P83636-601
	AMD Ryzen AI 7 445 (16 GB, PRC)	P83641-601
	AMD Ryzen AI 5 430 (16 GB)	P83639-601
	AMD Ryzen AI 5 430 (16 GB, PRC)	P83640-601
	AMD Ryzen 7 250 (32 GB)	P83646-601
	AMD Ryzen 7 250 (32 GB, PRC)	P83647-601
	AMD Ryzen 7 250 (16 GB)	P83644-601
	AMD Ryzen 7 250 (16 GB, PRC)	P83645-601
	AMD Ryzen 5 230 (16 GB)	P83648-601
	AMD Ryzen 5 230 (16 GB, PRC)	P83649-601
	System board for use in models with an Intel processor	
	Intel Core Ultra 9 386H processor, 32 GB	P83593-601
	Intel Core Ultra 7 355 processor, 32 GB	P83592-601
	Intel Core Ultra 7 355 processor, 16 GB	P83591-601
	Intel Core 7 150U processor, 16 GB	P83594-601
	Intel Core Ultra 5 322 processor, 16GB	P83590-601
	Intel Core Ultra 5 120U processor, 16 GB	P83589-601
(7)	Battery (4-cell, 68 Whr, 4.405 Ah capacity, polymer lithium (PL))	P13980-001
(8)	Speakers	P83621-001
(9)	Bottom cover	
	Glacier silver	P83603-001
	Meteor silver	P83604-001

Table 3-1 Computer major component descriptions and part numbers (continued)

Item	Component	Spare part number
	Silk sand	P83605-001
	Starlit blue	P83606-001
(10)	Fan	P83622-001
(11)	Heat sink assembly	
	AMD:	
	For use in models with the AMD Ryzen AI 9 465 processor	P83625-001
	For use in models with an AMD Ryzen AI 7 445 processor	P83627-001
	For use in models with the AMD Ryzen AI 5 430 or AMD Ryzen 7 250 processor	P83626-001
	Intel:	
	For use in models with Intel Core Ultra 5, 7, and 9 processors	P83624-001
	For use in models with Intel Core 5 and 7 processors	P83623-001
(12)	WLAN module	
	Intel BE211 with Bluetooth 6.0, M.2 2230, non-vPro	P36621-005
	Intel AX8922AE with Bluetooth 5.4, M.2 2230	P44408-005
	MediaTek MT7920 with Bluetooth 5.4, Wi-Fi 6, M.2 2230	P17386-005
	Realtek RTL8852BE with Bluetooth 5.4, M.2 2230	P06350-005
(13)	Solid-state drive (M.2 2280)	
	1 TB, PCIe 5 × 4	P73030-005
	512 GB, PCIe 5 × 4	P73029-005
	1 TB, PCIe 4 × 4	N77394-005
	512 GB, PCIe 4 × 4	N77392-005
(14)	USB board	P83615-001

Display assembly subcomponents

Use this illustration and table to identify the display assembly subcomponents.

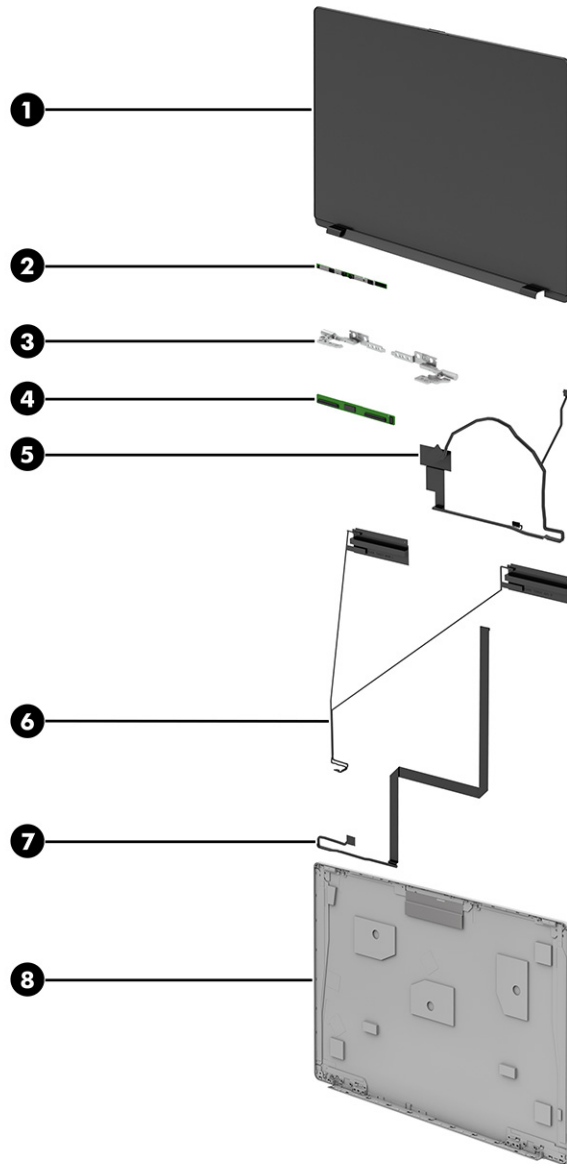

Table 3-2 Display component descriptions and part numbers

Item	Component	Spare part number
(1)	Display panel	
	NOTE: Display panel adhesive is available as spare part number N36079-001.	
	2.8K (2880 × 1800), antiglare, OLED, flat (3.2 mm), 45% NTSC, embedded DisplayPort (eDP) 1.5, 500 nits, 120 Hz (variable rate refresh [VRR])	P83597-001
	Full high definition (FHD) (1920 × 1200), touchscreen, antiglare, OLED, flat (3.2 mm), 45% NTSC, embedded DisplayPort (eDP) 1.2, 300 nits, 60 Hz (variable rate refresh [VRR])	P83598-001
	Full high definition (FHD) (1920 × 1200), non-touchscreen, antiglare, OLED, flat (3.2 mm), 45% NTSC, embedded DisplayPort (eDP) 1.2, 300 nits, 60 Hz (variable rate refresh [VRR])	P83596-001
(2)	Camera module (includes rubber piece)	P83632-001

Table 3-2 Display component descriptions and part numbers (continued)

Item	Component	Spare part number
(3)	Display hinges (includes left and right hinges)	P83633-001
(4)	Touch control board (with cable)	
	For use in models with AMD processors	P84442-001
	For use in models with Intel processors	P83635-001
(5)	Display cable	
	For use in models with AMD processors	P83929-001
	For use in models with Intel processors	P83618-001
(6)	WLAN antenna cable (includes antenna cables and transceivers)	P83619-001
(7)	Touch control cable (included in cable kit)	P83619-001
(8)	Display back cover	
	Touchscreen	
	Glacier silver	P83611-001
	Meteor silver	P83612-001
	Silk sand	P83613-001
	Starlit blue	P83614-001
	Non-touchscreen	
	Glacier silver	P83607-001
	Meteor silver	P83608-001
	Silk sand	P83609-001
	Starlit blue	P83610-001

Miscellaneous parts

Use this table to identify the miscellaneous parts.

Table 3-3 Miscellaneous part descriptions and part numbers

Component	Spare part number
AC adapters	
65 W USB Type-C, straight cable	P38779-001
65W AC adapter with Gallium Nitride technology (GaN), wall-mountable (WM), USB-C connector, 2-piece (2P), 2.0-meter cable, fixed	P58629-001
65W AC adapter GaN, WM, USB-C, (2P), 2.0-meter cable, detachable	P58630-001
65W AC adapter, USB-C connector, WM, 2P	P68491-001
65W AC adapter GaN, WM, USB-C connector, 2P, inline	P73759-001
Cable Kit (with antenna)	P83619-001
Power cords (C5, 1.0 m)	

Table 3-3 Miscellaneous part descriptions and part numbers (continued)

Component	Spare part number
Australia	L19358-001
Denmark	L19360-001
Europe	L19361-001
India	L19363-001
Israel	L19362-001
Italy	L19364-001
Japan	L19365-001
North America	L19367-001
South Africa	L19369-001
South Korea	L19366-001
Switzerland	L19370-001
Taiwan	L19372-001
Thailand	L19371-001
Thailand (with ADP)	M85418-001
United Kingdom	L19373-001
Power cords (duckhead, 1.0 m)	
Australia	P57784-001
Europe	P57782-001
India	P57790-001
South Korea	P57785-001
Thailand	P57786-001
United Kingdom	P57783-001
Screw Kit	P83620-001

4 Removal and replacement procedures preliminary requirements

Use this information to properly prepare to disassemble and reassemble the computer.

Tools required

You need the following tools to complete the removal and replacement procedures.

- Tweezers
- Nonconductive, nonmarking pry tool
- Magnetic Phillips P1 screwdriver

Service considerations

The following sections include some of the considerations that you must keep in mind during disassembly and assembly procedures.

 **NOTE:** As you remove each subassembly from the computer, place the subassembly and all accompanying screws away from the work area to prevent damage.

Plastic parts

Using excessive force during disassembly and reassembly can damage plastic parts.

Cables and connectors

Handle cables with extreme care to avoid damage.

 **IMPORTANT:** When servicing the computer, be sure that cables are placed in their proper locations during the reassembly process. Improper cable placement can damage the computer.

Apply only the tension required to unseat or seat the cables during removal and insertion. Handle cables by the connector whenever possible. In all cases, avoid bending, twisting, or tearing cables. Be sure that cables are routed so that they cannot be caught or snagged as you remove or replace parts. Handle flex cables with extreme care; these cables tear easily.

Drive handling

Note the following guidelines when handling drives.

 **IMPORTANT:** Drives are fragile components. Handle them with care. To prevent damage to the computer, damage to a drive, or loss of information, observe these precautions:

- Before removing or inserting a hard drive, shut down the computer. If you are unsure whether the computer is off or in hibernation or sleep mode, turn the computer on, and then shut it down through the operating system.

- Before handling a drive, be sure that you are discharged of static electricity. While handling a drive, avoid touching the connector.
 - Before removing an optical drive, be sure that a disc is not in the drive, and be sure that the optical drive tray is closed.
 - Handle drives on surfaces covered with at least 2.54 cm (1 inch) of shock-proof foam.
 - Avoid dropping drives from any height onto any surface.
 - After removing a hard drive or an optical drive, place it in a static-proof bag.
 - Avoid exposing an internal hard drive to products that have magnetic fields, such as monitors or speakers.
 - Avoid exposing a drive to temperature extremes or liquids.
 - If a drive must be mailed, place the drive in a bubble pack mailer or other suitable form of protective packaging, and label the package "FRAGILE."
-

Electrostatic discharge information

A sudden discharge of static electricity from your finger or other conductor can destroy static-sensitive devices or microcircuitry. Often the spark is neither felt nor heard, but damage occurs. An electronic device exposed to electrostatic discharge (ESD) might not appear to be affected at all and can work perfectly throughout a normal cycle. The device might function normally for a while, but it has been degraded in the internal layers, reducing its life expectancy.

Networks built into many integrated circuits provide some protection, but in many cases, the discharge contains enough power to alter device parameters or melt silicon junctions.

 **IMPORTANT:** To prevent damage to the device when you remove or install internal components, observe these precautions:

- Keep components in their electrostatic-safe containers until you are ready to install them.
 - Before touching an electronic component, discharge static electricity by using the guidelines described in [Personal grounding methods and equipment on page 24](#).
 - Avoid touching pins, leads, and circuitry. Handle electronic components as little as possible.
 - If you remove a component, place it in an electrostatic-safe container.
-

Generating static electricity

Follow these static electricity guidelines.

- Different activities generate different amounts of static electricity.
- Static electricity increases as humidity decreases.

Table 4-1 Static electricity occurrence based on activity and humidity

Event	55% relative humidity	40% relative humidity	10% relative humidity
Walking across carpet	7500 V	15,000 V	35,000 V
Walking across vinyl floor	3000 V	5000 V	12,000 V
Motions of bench worker	400 V	800 V	6000 V
Removing dual in-line packages (DIPs) from plastic tube	400 V	700 V	2000 V
Removing DIPs from vinyl tray	2000 V	4000 V	11,500 V
Removing DIPs from polystyrene foam	3500 V	5000 V	14,500 V
Removing bubble pack from PCB (printed circuit board)	7000 V	20,000 V	26,500 V
Packing PCBs in foam-lined box	5000 V	11,000 V	21,000 V

 **NOTE:** Multiple electric components can be packaged together in plastic tubes, trays, or polystyrene foam.

 **NOTE:** As little as 700 V of static electricity can degrade a product.

Preventing electrostatic damage to equipment

Many electronic components are sensitive to ESD. Circuitry design and structure determine the degree of sensitivity.

The following packaging and grounding precautions are necessary to prevent static electricity damage to electronic components:

- To avoid hand contact, transport products in static-safe containers such as tubes, bags, or boxes.
- Protect all electrostatic parts and assemblies with conductive or approved containers or packaging.
- Keep electrostatic-sensitive parts in their containers until they arrive at static-free stations.
- Place items on a grounded surface before removing them from their container.
- Always be properly grounded when touching a sensitive component or assembly.
- Avoid contact with pins, leads, or circuitry.
- Place reusable electrostatic-sensitive parts from assemblies in protective packaging or conductive foam.

Personal grounding methods and equipment

Using certain equipment can prevent static electricity damage to electronic components.

- **Wrist straps** are flexible straps with a maximum of $1\text{ M}\Omega \pm 10\%$ resistance in the ground cords. To provide proper ground, wear a strap snug against bare skin. Verify that the ground cord is connected and fits snugly into the banana plug connector on the grounding mat or workstation.
- You can use **heel straps, toe straps, and boot straps** at standing workstations. These straps are compatible with most types of shoes or boots. On conductive floors or dissipative floor mats, use them on both feet with a maximum of $1\text{ M}\Omega \pm 10\%$ resistance between the operator and ground.

Table 4-2 Static shielding protection levels

Method	Voltage
Antistatic plastic	1500
Carbon-loaded plastic	7500
Metalized laminate	15,000

Grounding the work area

To prevent static damage at the work area, follow these precautions.

- Cover the work surface with approved static-dissipative material.
- Use a wrist strap connected to a properly grounded work surface and use properly grounded tools and equipment.
- Use static-dissipative mats, foot straps, or air ionizers to give added protection.
- Handle electrostatic sensitive components, parts, and assemblies by the case or PCB laminate. Handle them only at static-free work areas.
- Turn off power and input signals before inserting and removing connectors or test equipment.
- Use fixtures made of static-safe materials when fixtures must directly contact dissipative surfaces.
- Keep the work area free of nonconductive materials, such as ordinary plastic assembly aids and polystyrene foam.
- Use conductive field service tools, such as cutters, screwdrivers, and vacuums.
- Avoid contact with pins, leads, or circuitry.

Recommended materials and equipment

HP recommends certain materials and equipment to prevent static electricity.

- Antistatic tape
- Antistatic smocks, aprons, or sleeve protectors
- Conductive bins and other assembly or soldering aids
- Conductive foam
- Conductive tabletop workstations with ground cord of $1\text{ M}\Omega \pm 10\%$ resistance
- Static-dissipative table or floor mats with hard tie to ground
- Field service kits
- Static awareness labels
- Wrist straps and footwear straps providing $1\text{ M}\Omega \pm 10\%$ resistance
- Material handling packages
- Conductive plastic bags

- Conductive plastic tubes
- Conductive tote boxes
- Opaque shielding bags
- Transparent metallized shielding bags
- Transparent shielding tubes

Cleaning your computer

Cleaning your computer regularly removes dirt and debris so that your device continues to operate at its best. Use the following information to safely clean the external surfaces of your computer.

Enabling HP Easy Clean (select products only)

HP Easy Clean helps you to avoid accidental input while you clean the computer surfaces. This software disables devices such as the keyboard, touch screen, and touchpad for a preset amount of time so that you can clean all computer surfaces.

1. Start HP Easy Clean in one of the following ways:
 - Select the **Start** menu, and then select **HP Easy Clean**.
 - Select the **HP Easy Clean** icon in the taskbar.
 - Select **Start**, and then select the **HP Easy Clean** tile.
2. Now that your device is disabled for a short period, see [Removing dirt and debris from your computer on page 26](#) for the recommended steps to clean the high-touch, external surfaces on your computer. After you remove the dirt and debris, you can also clean the surfaces with a disinfectant. See [Cleaning your computer with a disinfectant on page 27](#) for guidelines to help prevent the spread of harmful bacteria and viruses.

Removing dirt and debris from your computer

Here are the recommended steps to clean dirt and debris from your computer.

For computers with wood veneer, see [Caring for wood veneer \(select products only\) on page 28](#).

1. Wear disposable gloves made of latex (or nitrile gloves, if you are latex-sensitive) when cleaning the surfaces.
2. Turn off your device and unplug the power cord and other connected external devices. Remove any installed batteries from items such as wireless keyboards.

 **CAUTION:** To prevent electric shock or damage to components, never clean a product while it is turned on or plugged in.

3. Moisten a microfiber cloth with water. The cloth should be moist, but not dripping wet.

 **IMPORTANT:** To avoid damaging the surface, avoid abrasive cloths, towels, and paper towels.

4. Wipe the exterior of the product gently with the moistened cloth.

 **IMPORTANT:** Keep liquids away from the product. Avoid getting moisture in any openings. If liquid makes its way inside your HP product, it can cause damage to the product. Do not spray liquids directly on the product. Do not use aerosol sprays, solvents, abrasives, or cleaners containing hydrogen peroxide or bleach that might damage the finish.

5. Start with the display (if applicable). Wipe carefully in one direction, and move from the top of the display to the bottom. Finish with any flexible cables, like power cord, keyboard cable, and USB cables.
6. Be sure that surfaces have completely air-dried before turning the device on after cleaning.
7. Discard the gloves after each cleaning. Clean your hands immediately after you remove the gloves.

See [Cleaning your computer with a disinfectant on page 27](#) for recommended steps to clean the high-touch, external surfaces on your computer to help prevent the spread of harmful bacteria and viruses.

Cleaning your computer with a disinfectant

The World Health Organization (WHO) recommends cleaning surfaces, followed by disinfection, as a best practice for preventing the spread of viral respiratory illnesses and harmful bacteria.

After cleaning the external surfaces of your computer using the steps in [Removing dirt and debris from your computer on page 26](#), [Caring for wood veneer \(select products only\) on page 28](#), or both, you might also choose to clean the surfaces with a disinfectant. A disinfectant that is within HP's cleaning guidelines is an alcohol solution consisting of 70% isopropyl alcohol and 30% water. This solution is also known as rubbing alcohol and is sold in most stores.

Follow these steps when disinfecting high-touch, external surfaces on your computer:

1. Wear disposable gloves made of latex (or nitrile gloves, if you are latex-sensitive) when cleaning the surfaces.
2. Turn off your device and unplug the power cord and other connected external devices. Remove any installed batteries from items such as wireless keyboards.

 **CAUTION:** To prevent electric shock or damage to components, never clean a product while it is turned on or plugged in.

3. Moisten a microfiber cloth with a mixture of 70% isopropyl alcohol and 30% water. The cloth should be moist, but not dripping wet.

 **CAUTION:** Do not use any of the following chemicals or any solutions that contain them, including spray-based surface cleaners: bleach, peroxides (including hydrogen peroxide), acetone, ammonia, ethyl alcohol, methylene chloride, or any petroleum-based materials, such as gasoline, paint thinner, benzene, or toluene.

 **IMPORTANT:** To avoid damaging the surface, avoid abrasive cloths, towels, and paper towels.

4. Wipe the exterior of the product gently with the moistened cloth.

 **IMPORTANT:** Keep liquids away from the product. Avoid getting moisture in any openings. If liquid makes its way inside your HP product, it can cause damage to the product. Do not spray liquids directly on the product. Do not use aerosol sprays, solvents, abrasives, or cleaners containing hydrogen peroxide or bleach that might damage the finish.

5. Start with the display (if applicable). Wipe carefully in one direction, and move from the top of the display to the bottom. Finish with any flexible cables, like power cord, keyboard cable, and USB cables.
6. Be sure that surfaces have completely air-dried before turning the device on after cleaning.
7. Discard the gloves after each cleaning. Clean your hands immediately after you remove the gloves.

Caring for wood veneer (select products only)

Your product might feature high-quality wood veneer. As with all natural wood products, proper care is important for best results over the life of the product. Because of the nature of natural wood, you might see unique variations in the grain pattern or subtle variations in color, which are normal.

- Clean the wood with a dry, static-free microfiber cloth or chamois.
- Avoid cleaning products containing substances such as ammonia, methylene chloride, acetone, turpentine, or other petroleum-based solvents.
- Do not expose the wood to sun or moisture for long periods of time.
- If the wood becomes wet, dry it by dabbing with an absorbent, lint-free cloth.
- Avoid contact with any substance that might dye or discolor the wood.
- Avoid contact with sharp objects or rough surfaces that might scratch the wood.

See [Removing dirt and debris from your computer on page 26](#) for the recommended steps to clean the high-touch, external surfaces on your computer. After you remove the dirt and debris, you can also clean the surfaces with a disinfectant. See [Cleaning your computer with a disinfectant on page 27](#) for sanitizing guidelines to help prevent the spread of harmful bacteria and viruses.

Packaging and transporting guidelines

Follow these grounding guidelines when packaging and transporting equipment.

- To avoid hand contact, transport products in static-safe tubes, bags, or boxes.
- Protect ESD-sensitive parts and assemblies with conductive or approved containers or packaging.
- Keep ESD-sensitive parts in their containers until the parts arrive at static-free workstations.
- Place items on a grounded surface before removing items from their containers.
- Always be properly grounded when touching a component or assembly.
- Store reusable ESD-sensitive parts from assemblies in protective packaging or nonconductive foam.
- Use transporters and conveyors made of antistatic belts and roller bushings. Be sure that mechanized equipment used for moving materials is wired to ground and that proper materials are selected to avoid static charging. When grounding is not possible, use an ionizer to dissipate electric charges.

Accessing support information

Use this information to find the HP support that you need.

Table 4-3 Support information locations

Service consideration	Path to access information
Records of reported failure incidents stored on the computer	<p>Windows:</p> <p>Pre-operating system failures are logged in the BIOS Event Log. To view the BIOS Event Log:</p> <ol style="list-style-type: none"> 1. Press the power button. 2. Immediately and repeatedly press esc when the power button light turns white. <p>NOTE: If you do not press esc at the appropriate time, you must restart the computer and again repeatedly press esc when the power button light turns white to access the utility.</p> <ol style="list-style-type: none"> 3. Press f10 to enter the BIOS setup. 4. Complete one of these tasks: <ul style="list-style-type: none"> • (On commercial products) Under the Main tab, select BIOS event log, and then select View BIOS Event Log. • (On consumer products) Under the Main tab, select System Log. <p>Post-operating system failures are logged in the Event Viewer.</p> <ol style="list-style-type: none"> 1. Turn on the computer and allow the operating system to open. 2. Select the search icon  in the taskbar. 3. Type <code>Event Viewer</code>, and then press enter. 4. Select the log from the left panel. Details display in the right panel. <p>ChromeOS™:</p> <ol style="list-style-type: none"> 1. Go to support.google.com/chrome. 2. Search <code>collect Chrome device logs</code>.
Technical bulletins and alerts	<p>To find technical bulletins, alerts, guides, and whitepapers:</p> <ol style="list-style-type: none"> 1. Go to www.hp.com/support. 2. Follow the instructions to find your product. 3. Select Bulletins and Alerts to view technical bulletins.
Repair professionals	<p>To locate repair professionals:</p> <ol style="list-style-type: none"> 1. Go to www.hp.com. 2. Select Authorized service providers. 3. Select your location.
Component and diagnosis information, failure detection, and required action	<p>To locate diagnosis information and actions:</p> <ol style="list-style-type: none"> 1. Go to http://www.hp.com/go/techcenter/pcdiags. 2. Select the issue you want to diagnose.

5 Removal and replacement procedures for Customer Self-Repair parts

This chapter provides removal and replacement procedures for Customer Self-Repair parts.

 **NOTE:** The Customer Self-Repair program is not available in all locations. Installing a part that is not supported by the Customer Self-Repair program can void your warranty. Check your warranty to determine whether Customer Self-Repair is supported in your location.

 **NOTE:** The [HP Support YouTube Channel](#) (in English) has videos that provide step-by-step removal and replacement instructions for many common parts and models.

Component replacement procedures

Use these procedures to remove and replace computer components.

 **NOTE:** Details about your computer, including model, serial number, product key, and length of warranty, are on the service tag at the bottom of your computer.

 **NOTE:** HP continually improves and changes product parts. For complete and current information about supported parts for your computer, go to <https://partsurfer.hp.com/>, select your country or region, and then follow the on-screen instructions.

Make special note of each screw size and location during removal and replacement.

Preparation for disassembly

Use these procedures to remove and replace computer components.

For initial safety procedures, see [Removal and replacement procedures preliminary requirements on page 22](#).

1. Turn off the computer. If you are unsure whether the computer is off or in hibernation or sleep mode, turn the computer on, and then shut it down through the operating system.
2. Disconnect the power from the computer by unplugging the power cord from the computer.
3. Disconnect all external devices from the computer.

Bottom cover

Use these procedures and illustrations to remove the bottom cover.

Table 5-1 Bottom cover description and part number

Description	Spare part number
Bottom cover (glacier silver)	P83603-001
Bottom cover (meteor silver)	P83604-001
Bottom cover (silk sand)	P83605-001

Table 5-1 Bottom cover description and part number (continued)

Description	Spare part number
Bottom cover (starlit blue)	P83606-001

Before removing the bottom cover, prepare the computer for disassembly (see [Preparation for disassembly on page 30](#)).

Remove the bottom cover:

1. Remove the four Phillips M2.0 × 4.0 screws that secure the bottom cover to the computer.

 **NOTE:** The bottom cover includes three non-captive screws (**1**) and one captive (not removable) screw (**2**) that causes the cover to pop up when you loosen the screw. **After the cover pops up, do not continue to loosen the captive screw.**

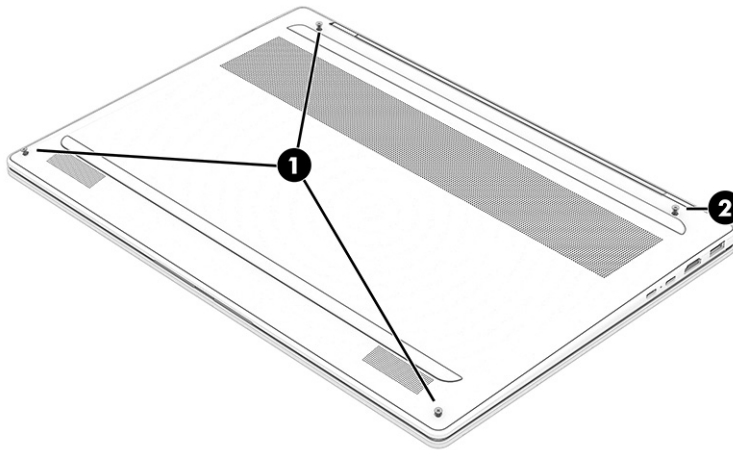

2. Use a nonmarking, nonconductive tool (**1**) to release the edges of the bottom cover from the computer.

Hand write the product information onto the label of the new bottom cover. Use a ballpoint pen or marker to avoid smudging.

Example of label information

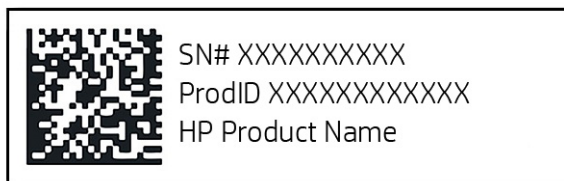

New bottom cover label location

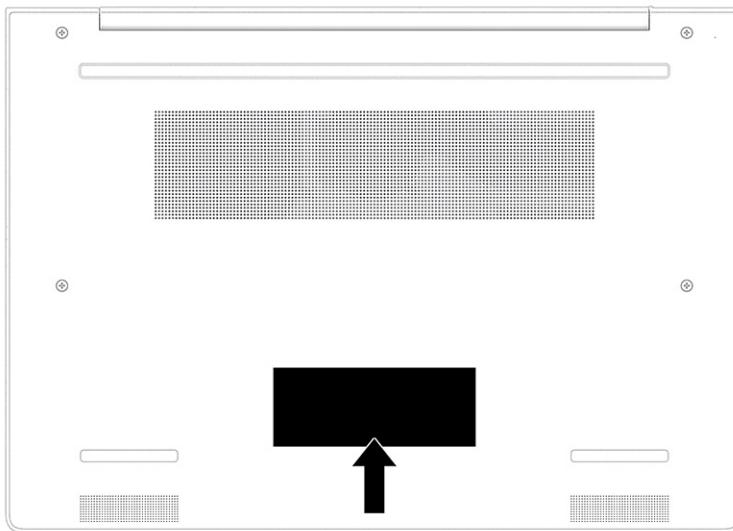

Battery

The battery removal procedure differs depending on whether you are removing and replacing the existing battery or installing a new battery. To install a new battery, you must use a revive kit.

- To remove and replace the existing battery, see [Removing and reinstalling the same battery on page 33](#).
- To install a new battery, see [Installing a new battery on page 35](#).

Removing and reinstalling the same battery

Use this procedure and illustration to remove the battery.

⚠ WARNING! To avoid personal injury and damage to the product:

- Do *not* puncture, twist, or crack the battery.
- Do *not* cause an external puncture or rupture to the battery, which can cause a short inside the battery that can result in battery thermal runaway.

- Do *not* handle or touch the battery enclosure with sharp objects such as tweezers or pliers, which might puncture the battery.
- Do *not* compress or squeeze the battery case with tools or heavy objects stacked on top of the case. These actions can apply undue force on the battery.
- Do *not* touch the connectors with any metallic surface or object, such as metal tools, screws, or coins, which can cause shorting across the connectors.

For additional battery information, see the *Regulatory, Safety, and Environmental Notices*. To access this guide, select the **Search** icon in the taskbar, type `HP Documentation` in the search box, and then select **HP Documentation**.

Before removing the battery, follow these steps:

1. Prepare the computer for disassembly (see [Preparation for disassembly on page 30](#)).
2. Remove the bottom cover (see [Bottom cover on page 30](#)).

⚠ WARNING! To reduce potential safety issues, use only the user-replaceable battery provided with the computer, a replacement battery provided by HP, or a compatible battery purchased from HP.

📌 IMPORTANT: Removing a battery that is the sole power source for the computer can cause loss of information. To prevent loss of information, save your work or shut down the computer through Windows before you remove the battery.

Remove the battery:

1. Disconnect the battery cable (1) from the system board.
2. Remove the five Phillips M2.0 × 4.0 screws (2) that secure the battery to the computer.
3. Tilt the battery away from the computer (3).
4. Remove the battery from the computer (4).

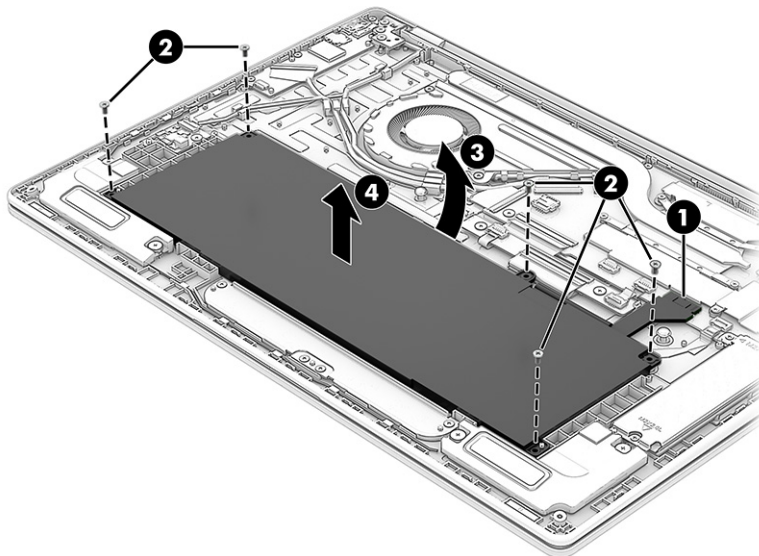

Reverse this procedure to install the battery.

 **NOTE:** When reinstalling the battery, be sure to completely reassemble the computer and plug in the AC adapter before turning the computer on. In addition, the battery cable has two different connectors: the black connector is attached to the battery and the white connector is attached to the system board.

Installing a new battery

Use these procedures and illustrations to install the battery. You must use a revive kit to remove the old battery and install a new one. The revive kit includes an empty containment tray and a containment tray with a battery preinstalled.

Table 5-2 Battery description and part number

Description	Spare part number
4 cell, 68 Whr, polymer, HP Long Life	P13980-001

Before starting this replacement procedure:

- Ensure other individuals are sufficiently clear of your workspace.
- Ensure your workspace is clear of any flammable material such as paper or oils.
- Locate the nearest ABC dry chemical fire extinguisher for use in an emergency.

 **WARNING!** This procedure requires removing the battery or disconnecting the battery cable. Use care to avoid bending, twisting, or puncturing the battery regardless of its condition. Failure to follow this replacement guide or to use HP recommended tools might damage the system and/or cause a safety hazard.

- Do *not* remove the battery from the containment tray.
- Do *not* handle or touch the battery enclosure with sharp objects such as tweezers or pliers, which might puncture the battery.
- Do *not* touch the connectors with any metallic surface or object, such as metal tools, screws, or coins, which can cause shorting across the connectors.

Should a part become stuck or difficult to remove when opening a unit where a swollen battery is suspected, or if the battery becomes stuck in the unit, stop and contact HP Support for assistance. Do not try to remove a battery by force.

 **NOTE:** Screw locations, latch locations, and internal components might vary.

Before removing the battery, follow these steps:

1. Prepare the computer for disassembly (see [Preparation for disassembly on page 30](#)).

2. Remove the bottom cover (see [Bottom cover on page 30](#)).

⚠ WARNING! To reduce potential safety issues, use only the user-replaceable battery provided with the computer, a replacement battery provided by HP, or a compatible battery purchased from HP.

📌 IMPORTANT: Removing a battery that is the sole power source for the computer can cause loss of information. To prevent loss of information, save your work or shut down the computer through Windows before you remove the battery.

1. Remove the battery using the revive kit:

a. Disconnect the battery cable from the system board. The connector location might vary.

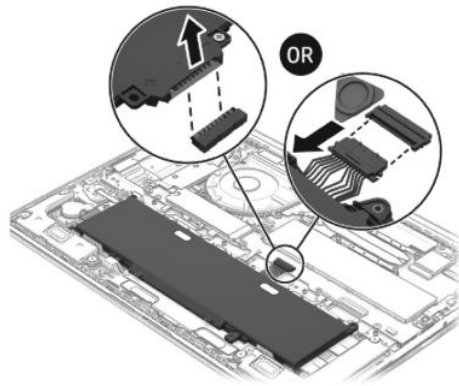

b. Open the empty battery containment tray.



- c. Remove the paper backing layer from the adhesive on the tray.

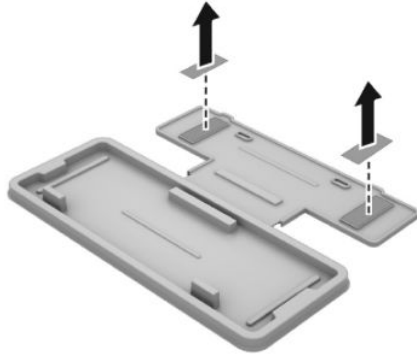

- d. Turn the tray **(1)** over so that the adhesive is facing down.
- e. Place the tray **(2)** centered on the battery.
- f. Press down on the indentations on the tray **(3)** to adhere it to the battery.

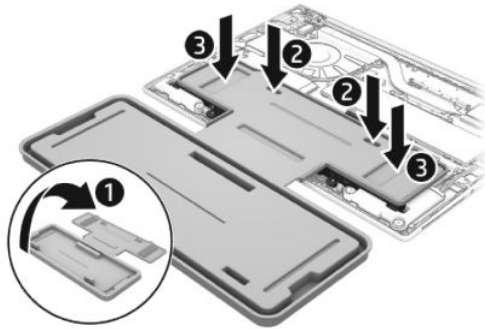

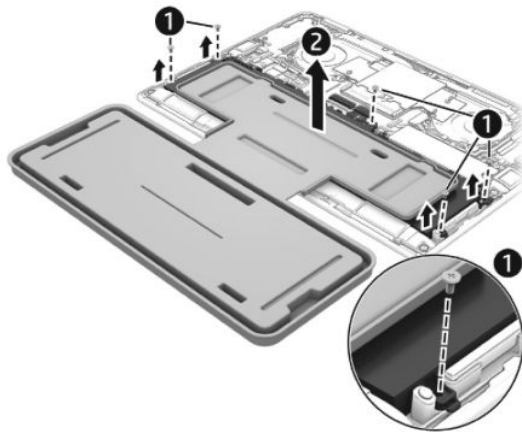

- g. Remove the Phillips screws **(1)** that secure the battery to the computer. Number of screws and screw locations might vary.

- h. Lift the top of the tray (2) to remove the battery from the computer.

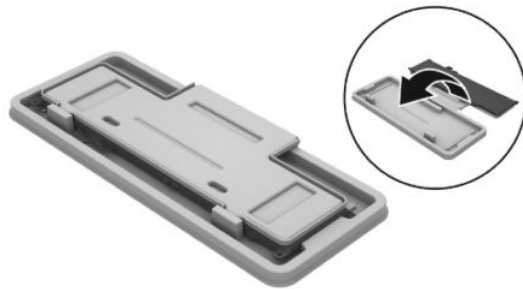

- i. Rotate the battery up and over into the cavity of the containment tray.



 **NOTE:** Please recycle responsibly. For more information about recycling programs, see the HP website at <http://www.hp.com/recycle>.

- 2. Install the battery using the revive kit:
 - a. Open the containment tray that includes the new battery.

- b. Turn the tray (1) over so the battery is facing downward, and then insert the battery (2) into the computer. Adhesive secures the battery to the tray.

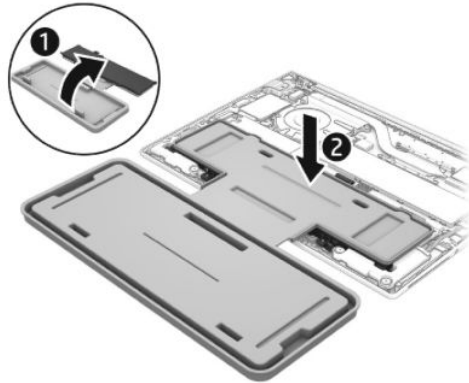

- c. Install the Phillips screws (1) to secure the battery. Number of screws and screw locations might vary.
- d. Lift the containment tray (2) off the battery.

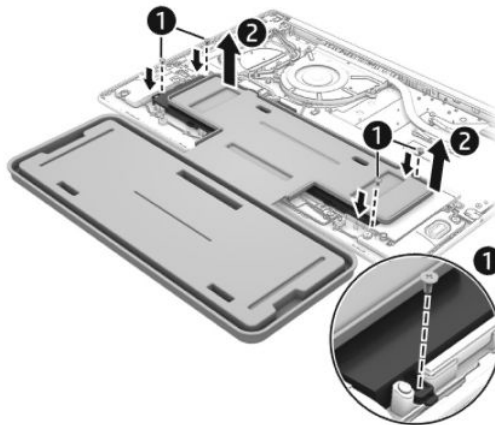

- e. Connect the battery cable to the system board. The connector location might vary.

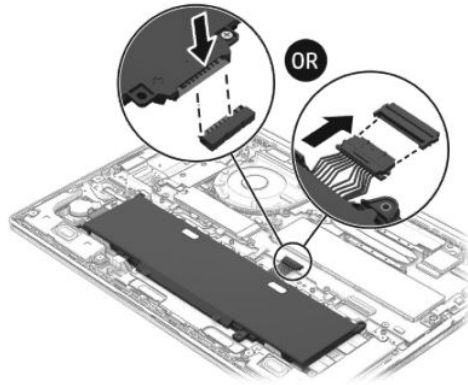



 **NOTE:** When replacing the battery, be sure to completely reassemble the computer and plug in the AC adapter before turning the computer on.

6 Removal and replacement procedures for authorized service provider parts

This chapter provides removal and replacement procedures for authorized service provider parts.

 **IMPORTANT:** Only an authorized service provider should access the components described in this chapter. Accessing these parts can damage the computer or void the warranty.

 **NOTE:** Details about your computer, including model, serial number, product key, and length of warranty, are on the service tag at the bottom of your computer.

 **NOTE:** The [HP Support YouTube Channel](#) (in English) has videos that provide step-by-step removal and replacement instructions for many common parts and models.

Component replacement procedures

Use the procedures described in this section to remove and replace computer components.

 **NOTE:** HP continually improves and changes product parts. For complete and current information about supported parts for your computer, go to <https://partsurfer.hp.com/>, select your country or region, and then follow the on-screen instructions.

Make special note of each screw size and location during removal and replacement.

Speakers

Use this procedure and illustration to remove the speakers.

Table 6-1 Speaker description and part number

Description	Spare part number
Speaker Kit	P83621-001

Before removing the speakers, follow these steps:

1. Prepare the computer for disassembly (see [Preparation for disassembly on page 30](#)).
2. Remove the bottom cover (see [Bottom cover on page 30](#)).

Remove the speakers:

1. Disconnect speaker cable from system board **(1)**.
2. Remove cable from clips beside the battery **(2)**.
3. Remove cable from clips below the battery **(3)**.
4. Remove the two Phillips M2.0 × 4.0 screws **(4)** that secure each speaker to the computer.

5. Remove the speakers **(5)** from the computer.

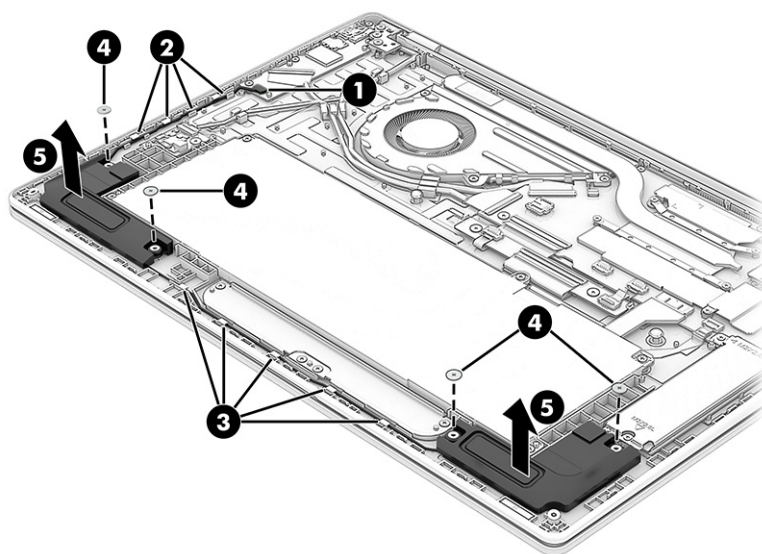

Reverse this procedure to install the speakers.

Transition board

Use this procedure and illustration to remove the transition board.

Table 6-2 Transition board description and part number

Description	Spare part number
Transition board with cable	P83617-001

Before removing the transition board, follow these steps:

1. Prepare the computer for disassembly (see [Preparation for disassembly on page 30](#)).
2. Remove the bottom cover (see [Bottom cover on page 30](#)).

Remove the transition board:

1. Disconnect the power cable from the transition board ZIF connector **(1)**.
2. Disconnect the cable from the system board ZIF connector **(1)**.
3. Remove the two Phillips M2.0 × 3.0 screws **(3)** that secure the board to the computer.
4. Disconnect the keyboard cable from the transition board ZIF connector **(4)**.
5. Disconnect the keyboard backlight cable from the transition board ZIF connector **(5)**.

6. Remove the board (6) from the computer.

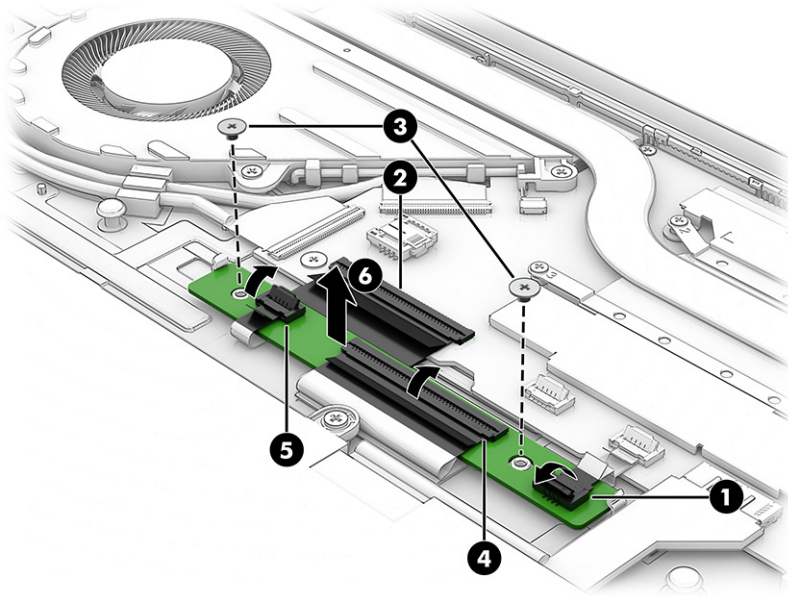

Reverse this procedure to install the transition board.

OLED power management board

Use this procedure and illustration to remove the OLED power management board.

Table 6-3 OLED power management board description and part number

Description	Spare part number
Power management board with cable	P83616-001

Before removing the power management board, follow these steps:

1. Prepare the computer for disassembly (see [Preparation for disassembly on page 30](#)).
2. Remove the bottom cover (see [Bottom cover on page 30](#)).
3. Disconnect the battery cable from the system board.

Remove the power management board:

1. Disconnect the cable from the ZIF connector (1).
2. Remove the Phillips M2.0 x 3.0 screw (2) that secures the board to the computer.

3. Remove the board **(3)** from the computer.

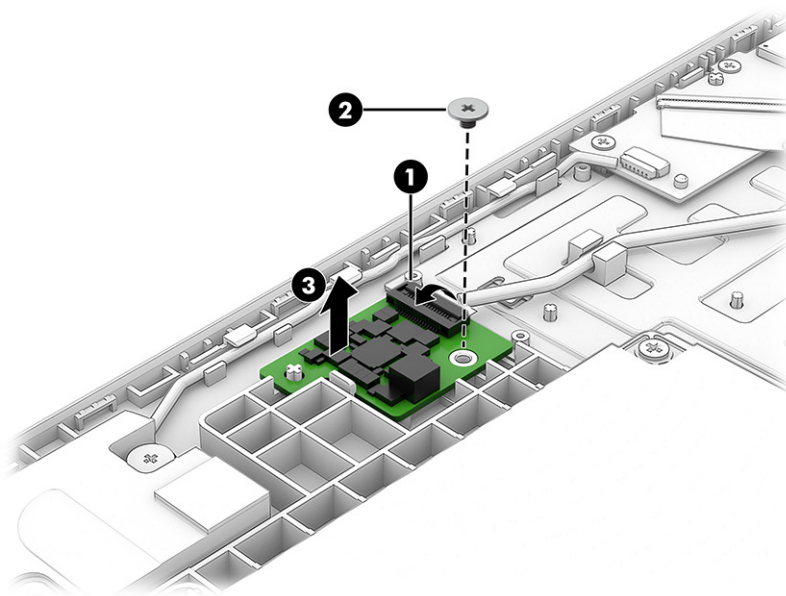

Reverse this procedure to install the power management board.

Solid-state drive

Use this procedure and illustration to remove the SSD.

Table 6-4 SSD descriptions and part numbers

Description	Spare part number
1 Tb PCIe 5×4 Non-Volatile Memory Express (NVMe)	P73030-005
1 Tb PCIe NVMe	N77394-005
512 GB PCIe 5×4 NVMe	P73029-005
512 GB PCIe NVMe	N77392-005

Before removing the SSD, follow these steps:

1. Prepare the computer for disassembly (see [Preparation for disassembly on page 30](#)).
2. Remove the bottom cover (see [Bottom cover on page 30](#)).
3. Disconnect the battery cable from the system board.

Remove the SSD:

1. Remove the two Phillips M2.0 × 2.5 screws **(1)** that secure the drive cover to the computer.
2. Remove the drive cover **(2)**.

3. Pull the drive **(3)** away from the socket to remove it.

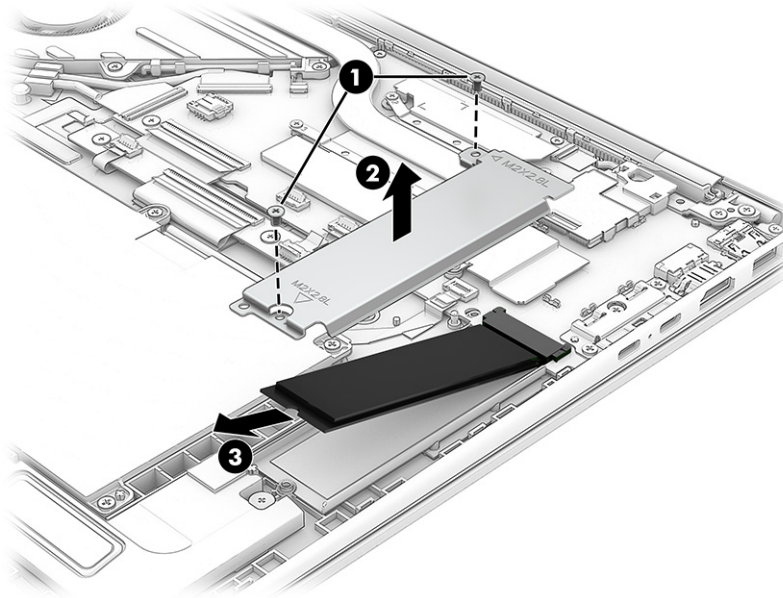

Reverse this procedure to install the SSD.

 **NOTE:** SSDs are designed with a notch to prevent incorrect insertion.

WLAN module

Use this procedure and illustration to install the WLAN module.

Table 6-5 WLAN module descriptions and part numbers

Description	Spare part number
Intel Wi-Fi 7 R2 Be211 + Bluetooth 6 multiple input, multiple output (MU-MIMO), supporting gigabit file transfer speeds	P44408-005
MediaTek MT7920 with Bluetooth 5.4, Wi-Fi 6, M.2 2230	P17386-005
Realtek Wi-Fi 7 + Bluetooth 6 WLAN	P36621-005
Realtek 8852BE-VT Wi-Fi 6 Bluetooth 5.4 WLAN	P06350-005

 **IMPORTANT:** To prevent an unresponsive system, replace the wireless module only with a wireless module authorized for use in the computer by the governmental agency that regulates wireless devices in your country or region. If you replace the module and then receive a warning message, remove the module to restore device functionality, and then contact technical support.

Before removing the WLAN module, follow these steps:

1. Prepare the computer for disassembly (see [Preparation for disassembly on page 30](#)).
2. Remove the bottom cover (see [Bottom cover on page 30](#)).
3. Disconnect the battery cable from the system board.

Remove the WLAN module:

1. Remove the plastic cover over the WLAN module.
2. Remove the Phillips M2.0 × 2.5 screw (1).
3. Carefully disconnect the two antenna cables (2) from the module.
4. Remove the WLAN module (3).

 **NOTE:** Models have either one or two WLAN antennas. On models with two antennas, the #1 white WLAN antenna cable connects to the WLAN module #1 Main terminal. The #2 black WLAN antenna cable connects to the WLAN module #1 Aux terminal.

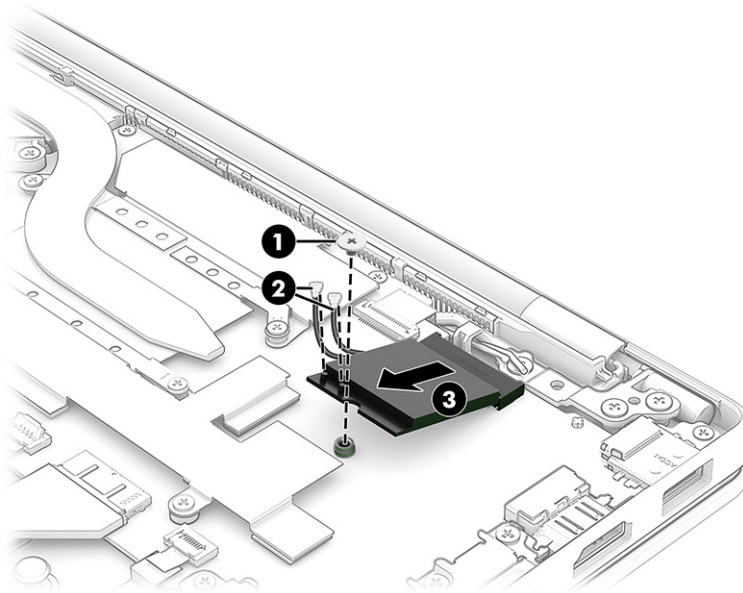

5. Thoroughly clean the thermal material from the surfaces of the WLAN module and the system board components each time the WLAN module is removed. Replacement thermal material is included with the WLAN module and system board spare part kits. The following illustration shows the replacement thermal material locations.

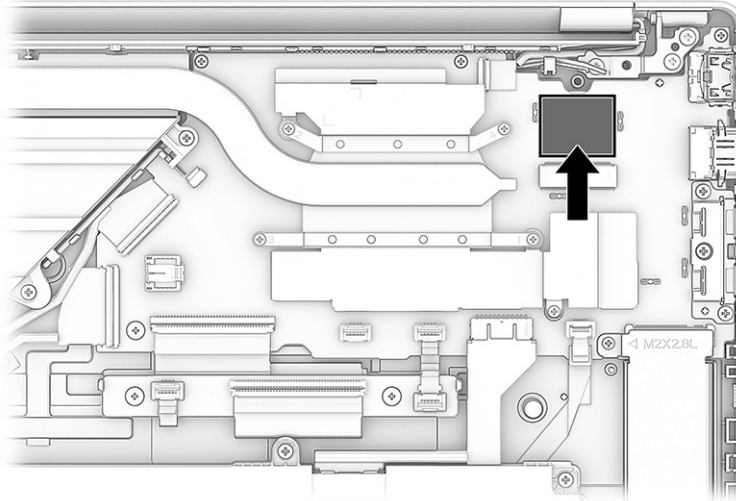

6. If the WLAN antenna is not connected to the terminal on the WLAN module, install a protective sleeve on the antenna connector, as shown in the following illustration.

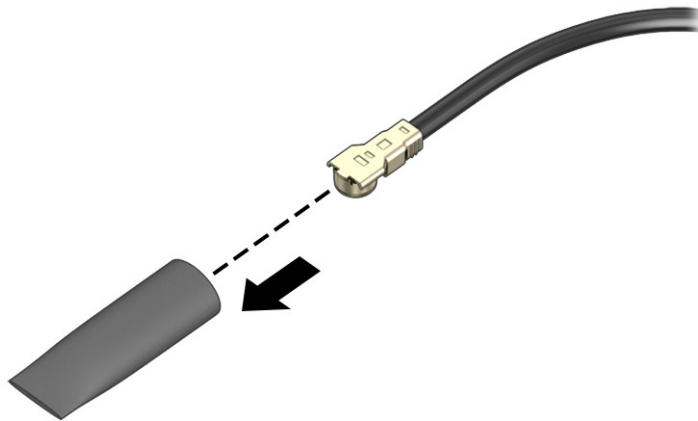

Reverse this procedure to install the WLAN module.

Fan

Use this procedure and illustration to remove the fan.

Table 6-6 Fan description and part number

Description	Spare part number
Fan assembly	P83622-001

Before removing the fan, follow these steps:

1. Prepare the computer for disassembly (see [Preparation for disassembly on page 30](#)).
2. Remove the bottom cover (see [Bottom cover on page 30](#)).

3. Disconnect the battery cable from the system board.

Remove the fan assembly:

1. Disconnect the fan cable (1) from the system board.
2. Remove the three Phillips M2.0 × 5.0 screws (2) that secure the fan to the computer, and then remove the fan (3) from the computer.

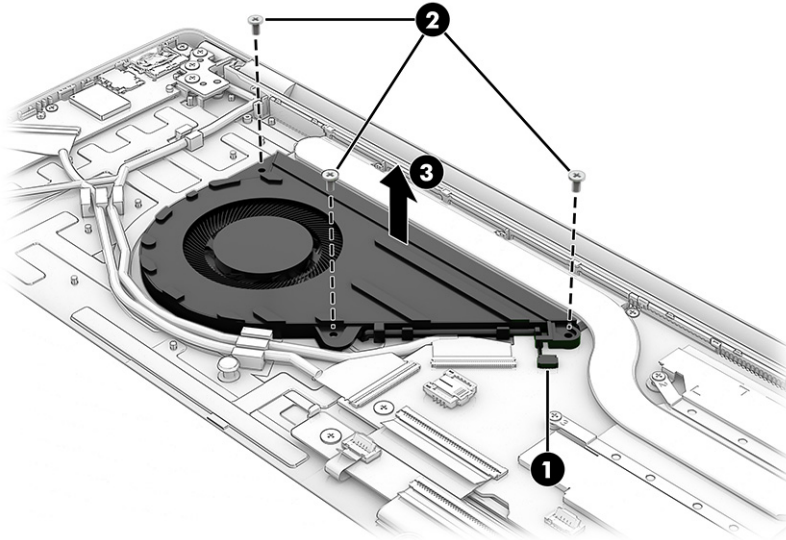

Reverse this procedure to install the fan.

USB board

Use this procedure and illustration to remove the USB board.

Table 6-7 USB board description and part number

Description	Spare part number
USB board with cable	P83615-001

Before removing the USB board, follow these steps:

1. Prepare the computer for disassembly (see [Preparation for disassembly on page 30](#)).
2. Remove the bottom cover (see [Bottom cover on page 30](#)).
3. Disconnect the battery cable from the system board.

Remove the USB board:

1. Disconnect the cable from USB board ZIF connector (1) and the system board ZIF connector (2).

2. Remove the USB board cable (3).

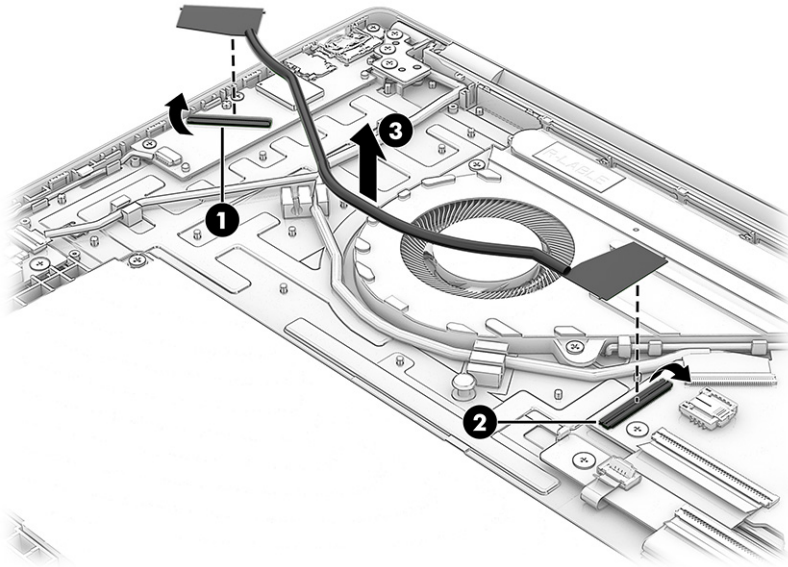

3. Remove the two Phillips M2.0 × 3.0 screws (1) that secure the board to the computer.
4. Remove the board (2) from the computer.

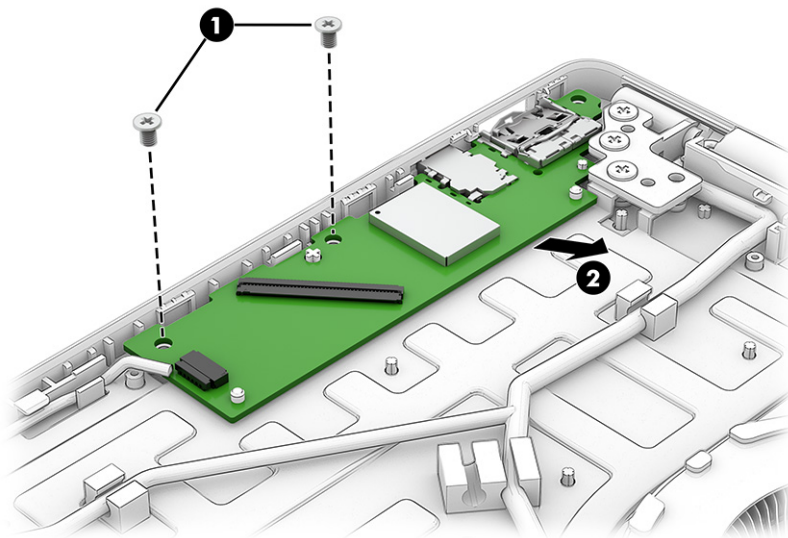

Reverse this procedure to install the USB board.

Touchpad

Use this procedure and illustration to remove the touchpad.

Table 6-8 Touchpad description and part number

Description	Spare part number
Touchpad (glacier silver)	P83628-001
Touchpad (meteor silver)	P83629-001
Touchpad (silk sand)	P83630-001
Touchpad (starlit blue)	P83631-001

Before removing the touchpad, follow these steps:

1. Prepare the computer for disassembly (see [Preparation for disassembly on page 30](#)).
2. Remove the bottom cover (see [Bottom cover on page 30](#)).
3. Remove the battery (see [Battery on page 33](#)).

Remove the touchpad:

1. Remove the four Phillips M2.0 × 3.0 screws **(1)** that secure the touchpad bracket to the computer.
2. Remove the touchpad bracket from the computer **(2)**.

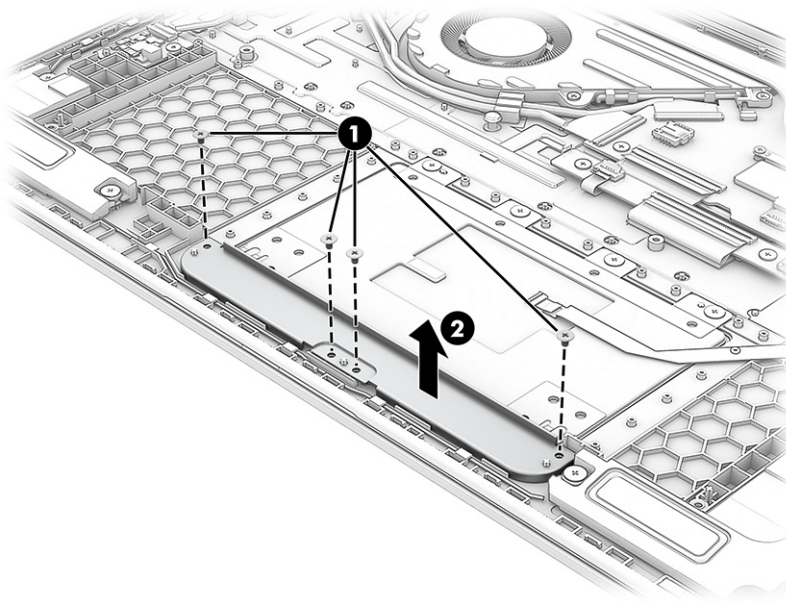

3. Disconnect the cable from the ZIF connector **(1)** on the system board.
4. Remove the four Phillips M2.0 × 3.0 screws **(2)** that secure the touchpad to the computer.

- Remove the touchpad (3) from the computer.

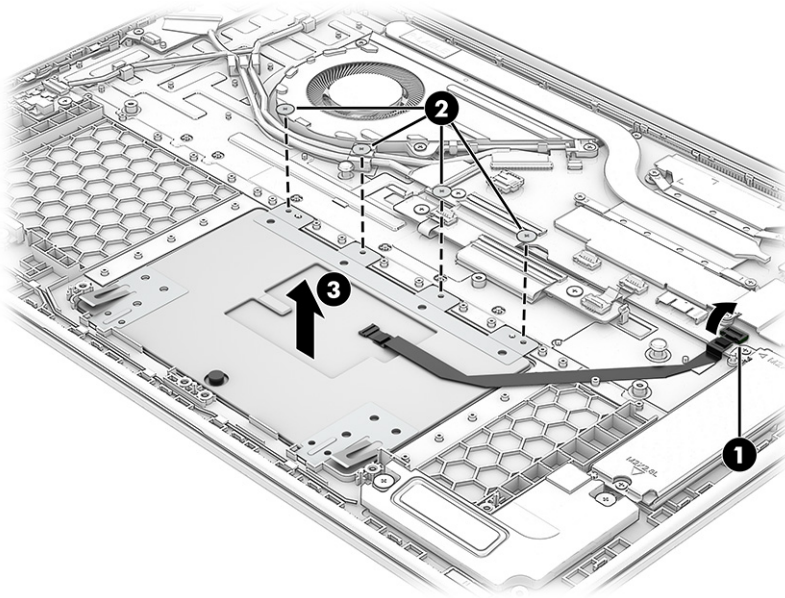

Reverse this procedure to install the touchpad.

Heat sink

Use these procedures and illustrations to remove the heat sink.

Table 6-9 Heat sink descriptions and part numbers

Description	Spare part number
For use in models with AMD Processors:	
For use in models with an AMD Ryzen AI 9 465 processor	P83625-001
For use in models with an AMD Ryzen AI 7 445 processor	P83627-001
For use in models with an AMD Ryzen AI 5 430 or AMD Ryzen 7 250 processor	P83626-001
For use in models with Intel Processors:	
Heat sink for use in models with Intel Core Ultra 5, 7, and 9 processors	P83624-001
Heat sink for use in models with Intel Core 5 and 7 processors	P83623-001

Before removing the heat sink, follow these steps:

- Prepare the computer for disassembly (see [Preparation for disassembly on page 30](#)).
- Remove the bottom cover (see [Bottom cover on page 30](#)).
- Disconnect the battery cable from the system board.
- Remove the Mylar cover over the heat sink and system board.

Remove the heat sink:

1. In the order indicated on the heat sink, remove the five Phillips M2.0 × 4.0 screws (1) that secure the heat sink to the computer.
2. Remove the heat sink (2) from the computer.

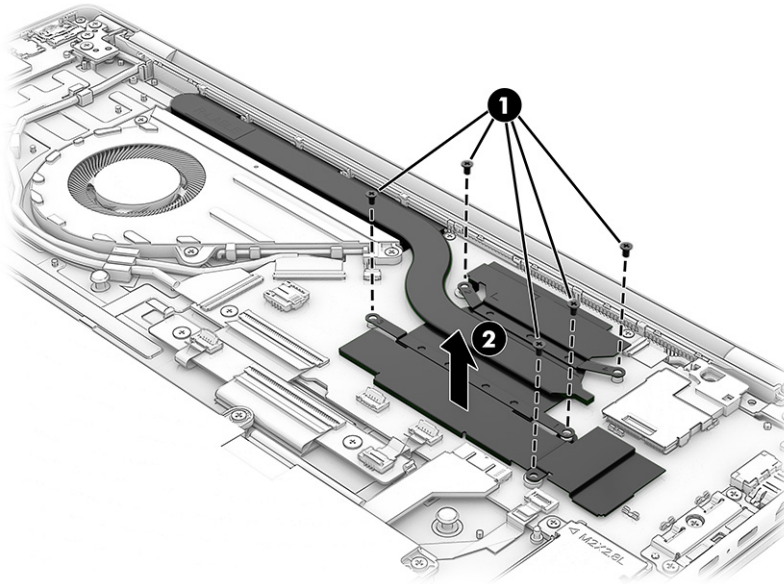

3. Thoroughly clean the thermal material from the surfaces of the heat sink and the system board components each time the heat sink is removed. Replacement thermal material is included with the heat sink and system board spare part kits. The following illustration shows the replacement thermal material locations.

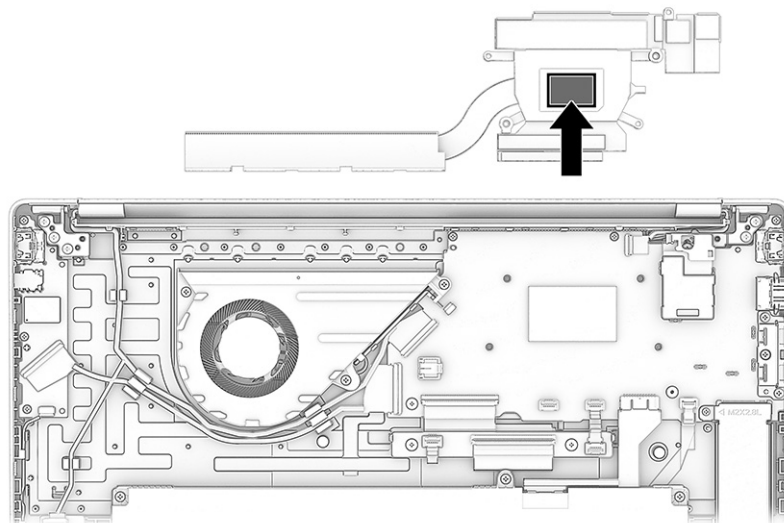

Reverse this procedure to install the heat sink.

System board

Use these procedures and illustrations to remove the system board.

Table 6-10 System board descriptions and part numbers

Description	Spare part number
System board (includes AMD processor):	
AMD Ryzen AI 9 465(32 GB)	P83638-601
AMD Ryzen AI 9 465 (32 GB, People's Republic of China)	P83643-601
AMD Ryzen AI 7 445 (32 GB)	P83637-601
AMD Ryzen AI 7 445 (32 GB, PRC)	P83642-601
AMD Ryzen AI 7 445 (16 GB)	P83636-601
AMD Ryzen AI 7 445 (16 GB, PRC)	P83641-601
AMD Ryzen AI 5 430 (16 GB)	P83639-601
AMD Ryzen AI 5 430 (16 GB, PRC)	P83640-601
AMD Ryzen 7 250 (32 GB)	P83646-601
AMD Ryzen 7 250 (32 GB, PRC)	P83647-601
AMD Ryzen 7 250 (16 GB)	P83644-601
AMD Ryzen 7 250 (16 GB, PRC)	P83645-601
AMD Ryzen 5 230 (16 GB)	P83648-601
AMD Ryzen 5 230 (16 GB, PRC)	P83649-601
System board (includes Intel processor):	
Intel Core Ultra9 processor with 32 Gb of memory	P83593-601
Intel Core Ultra7 processor with 32 GB of memory	P83592-601
Intel Core Ultra7 processor with 16 GB of memory	P83591-601
Intel Core Ultra5 processor with 16 GB of memory	P83590-601
Intel Core i7 processor with 16 GB of memory	P83594-601
Intel Core i5 processor with 16 GB of memory	P83589-601

Before removing the system board, follow these steps:

1. Prepare the computer for disassembly (see [Preparation for disassembly on page 30](#)).
2. Remove the bottom cover (see [Bottom cover on page 30](#)).
3. Disconnect the battery cable from the system board.
4. Remove the fan (see [Fan on page 47](#)).
5. Remove the SSD (see [Solid-state drive on page 44](#)).
6. WLAN module (see [WLAN module on page 45](#)).
7. Heat sink (see [Heat sink on page 51](#)).

Remove the system board:

1. Disconnect the following cables from the system board:

- Camera cable (ZIF) (1)
- Touchpad cable (ZIF) (2)
- Transition board cable (ZIF) (3)
- Keyboard cable (ZIF) (4)
- Keyboard backlight cable (ZIF) (5)
- USB board cable (ZIF) (6)
- Embedded DisplayPort (eDP) cable (ZIF) (7)

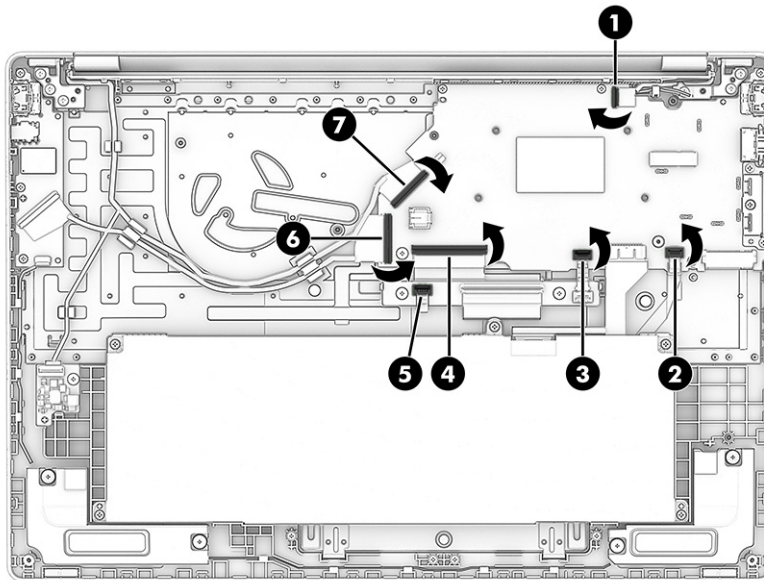

2. Remove the seven Phillips M2.0 × 5.0 screws (1) that secure the system board to the computer, and then pull the system board into the computer slightly to release it from the top cover (2).

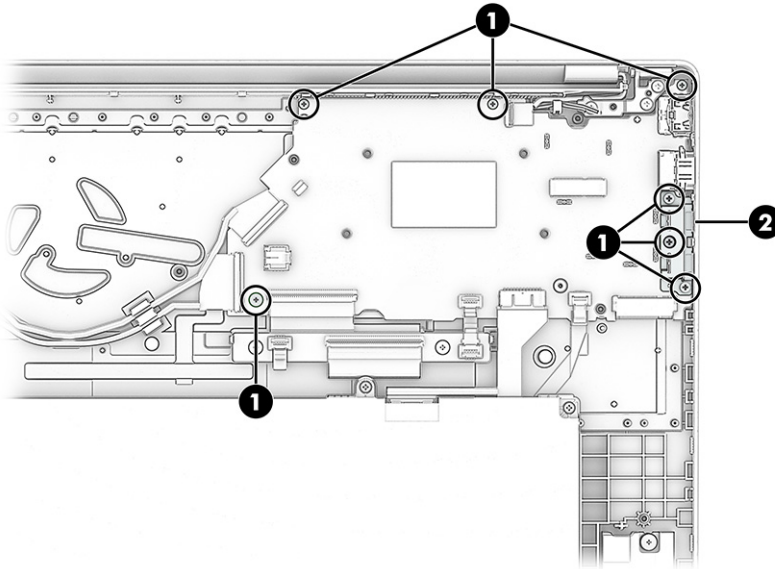

3. Remove the system board from the computer.

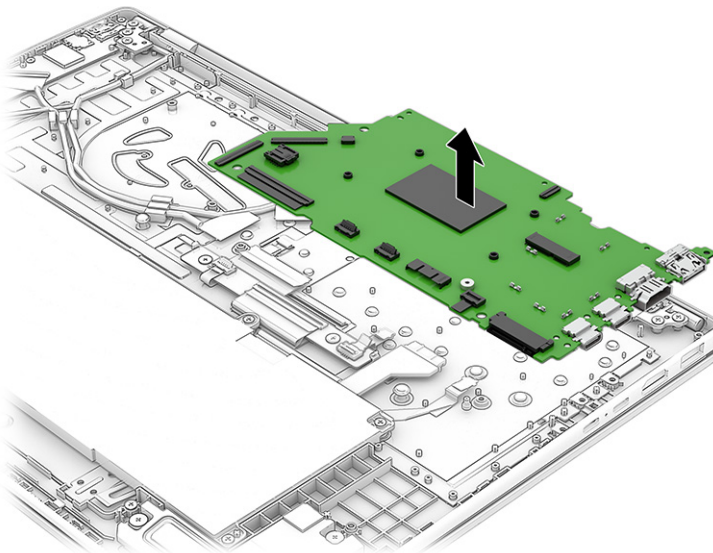

Reverse this procedure to install the system board.

Display assembly

Use these procedures and illustrations to remove and disassemble the display assembly.

Full hinge-up displays are not available as spare parts. Spare parts for displays are available only at the subcomponent level.

Before removing the display panel, follow these steps:

1. Prepare the computer for disassembly (see [Preparation for disassembly on page 30](#)).
2. Remove the bottom cover (see [Bottom cover on page 30](#)).

Remove the display assembly:

1. Remove the Mylar cover (1).
2. Remove the WLAN module cover (2).
3. Disconnect the battery cable from the system board.
4. Disconnect the following cables from the system board:
 - WLAN module cables (3)
 - Camera cable (4)
 - Embedded DisplayPort (eDP) cable (5)
 - Power management cable (6)

Display panel cables are available with the following spare part numbers for computers with AMD processors:

- P83929-001: Display cable only
- P83619-001: Cable kit with antenna

Display panel cables are available with the following spare part numbers for computers with Intel processors:

- P83618-001: Display cable only
- P83619-001: Cable kit with antenna

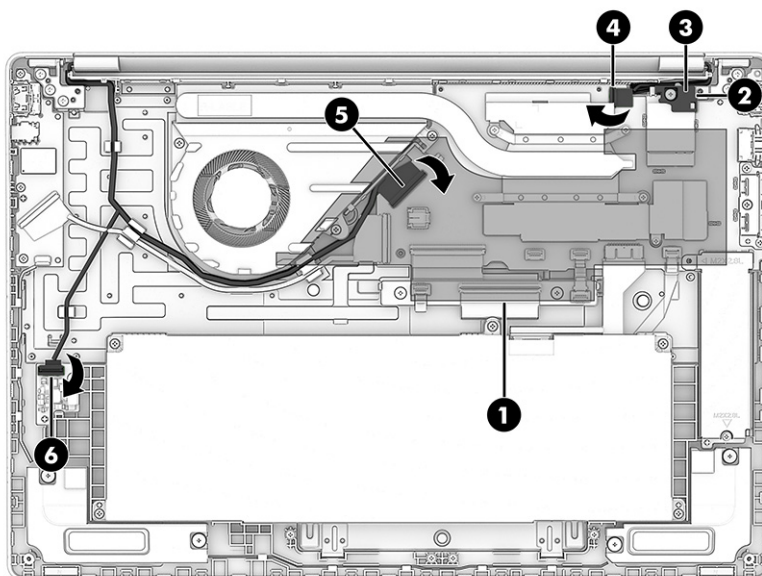

5. Rotate the display (1) upward to open the hinges, and then place the display on the edge of a table or other surface to avoid damaging the hinges or other parts during removal.

6. Remove the six Phillips M2.5 × 5.0 screws (2) that secure the display assembly to the computer.

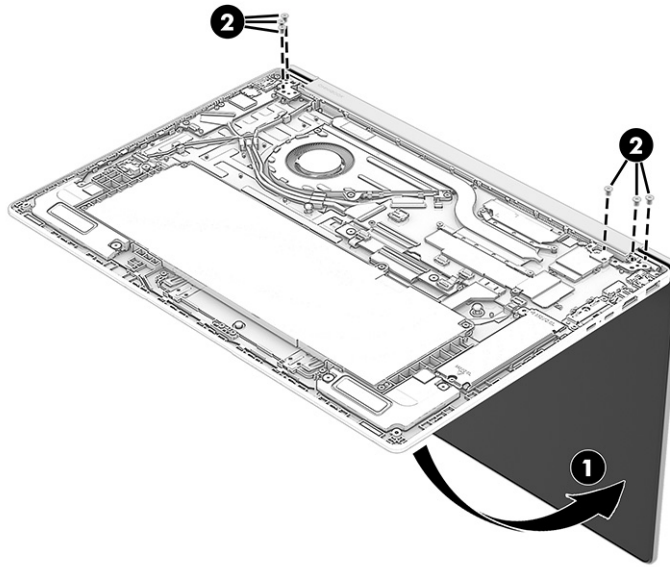

7. Separate the display assembly from the computer.

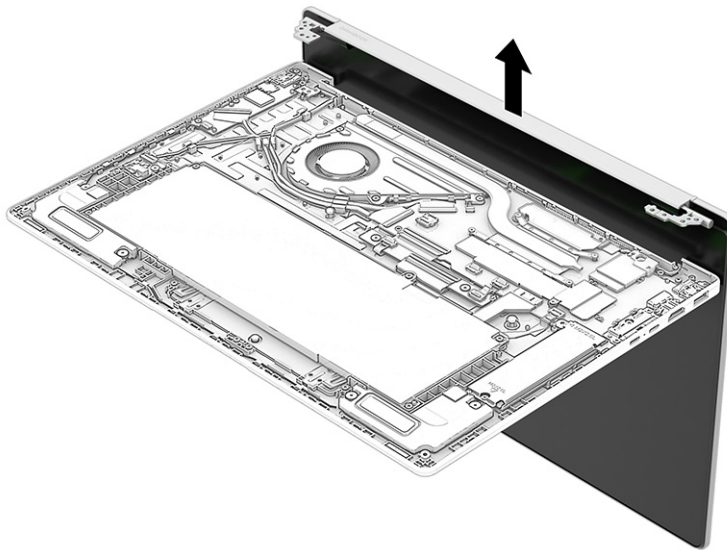

8. To replace display assembly subcomponents:

- a. With a heat gun (1), use the following steps to heat the panel.

 **IMPORTANT:** Maintain a distance of 4 inches (10 cm) between the heat gun and the surface to prevent bezel or panel damage.

- i. Set the heat gun temperature to 150°F.
- ii. Apply heat evenly around the bezel for 20-30 seconds.

- iii. For computers with a touchscreen, peel off the bezel and use care to pull the adhesive bar to remove it for disassembly.
- iv. For computers without a touchscreen, turn the bezel over and remove it for disassembly.
- b. Slide a flat tool **(2)** across the inside of the bottom of the bezel to release it.
- c. The display panel is secured to the display enclosure with tape that is installed under the left and right sides of the panel. To remove the panel, use tweezers to grasp the end of the tape **(3)**. While turning the tweezers, wrap the tape around the tweezers as you continue to pull the tape out from behind the display panel. You must pull the tape multiple times before it is completely removed.
- d. Remove the panel **(4)** from the display.

Display panels are available as the following spare part numbers:

P83597-001: 2.8K OLED

P83598-001: FHD touchscreen

P83596-001: FHD non-touchscreen

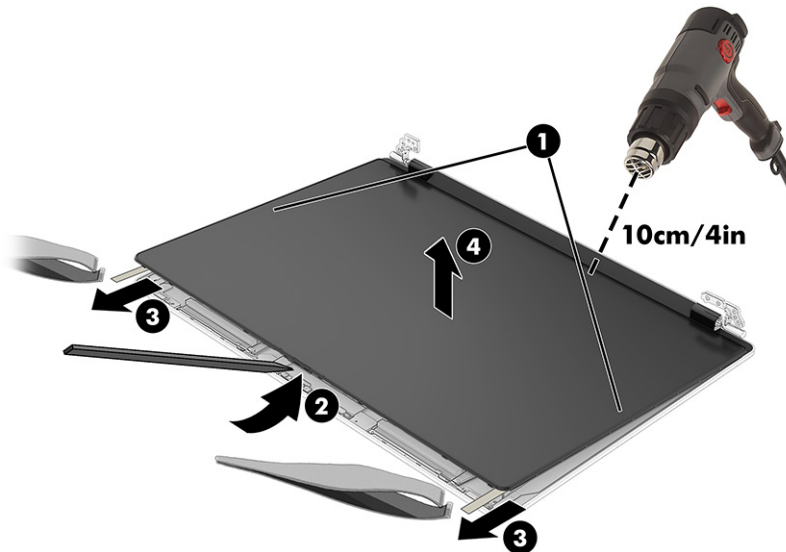

- 9. To remove the hinges from the display enclosure:
 - a. Remove the five Phillips broadhead M2.0 × 2.0 screws **(1)** from each hinge.
 - b. Remove the hinges **(2)** from the display.

A hinge kit is available as spare part number P83633-001.

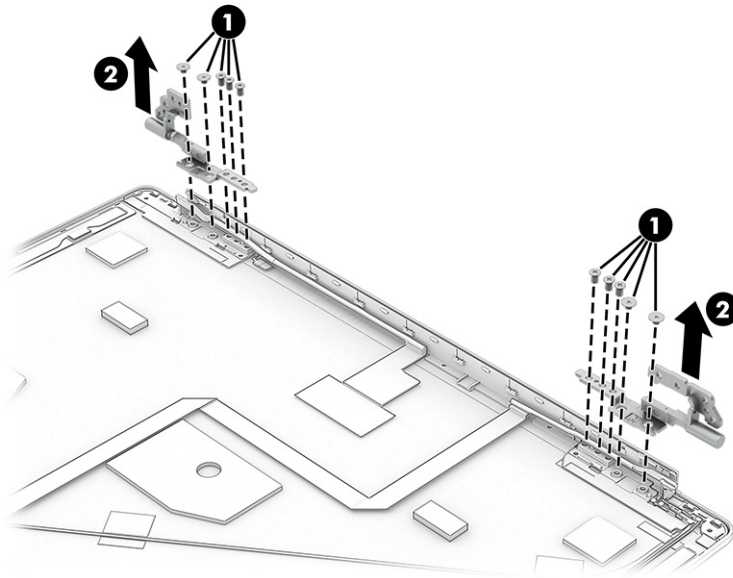

10. To remove the camera module:

- Remove the camera cable from the back cover.

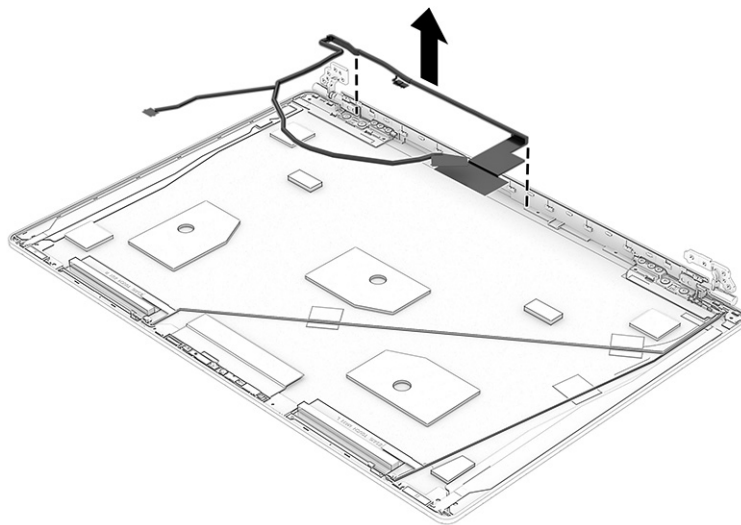

- a. Using a flat tool (1), pry up the adhesive foil.
- b. Lift up evenly across the module (2) and peel the module up from the display back cover, and then disconnect the cable from the reverse ZIF connector (3) on the module. The

camera module is available with the cable and rubber spacer in a kit as spare part number P83632-001.

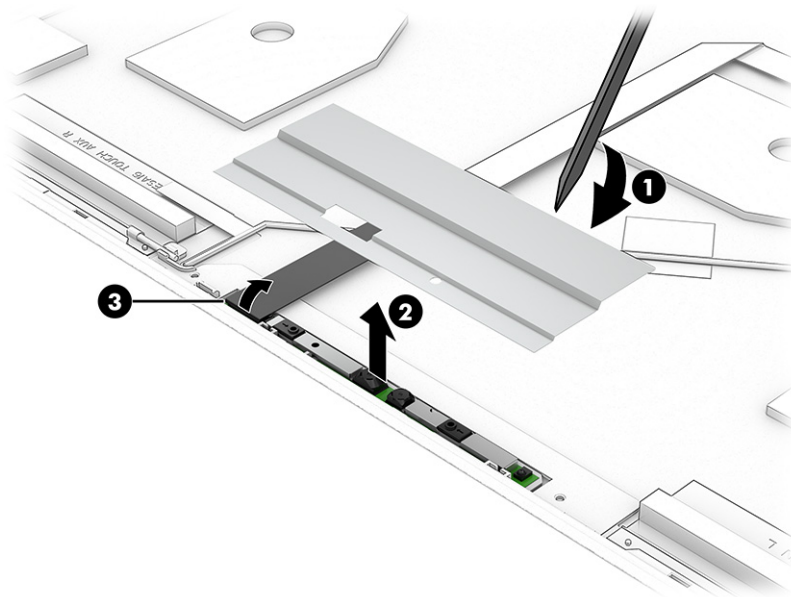

11. To remove the display/camera cable, disconnect the cable (1) from the camera module, peel the cable (2) off the inside of the display back cover, and then remove the cable.

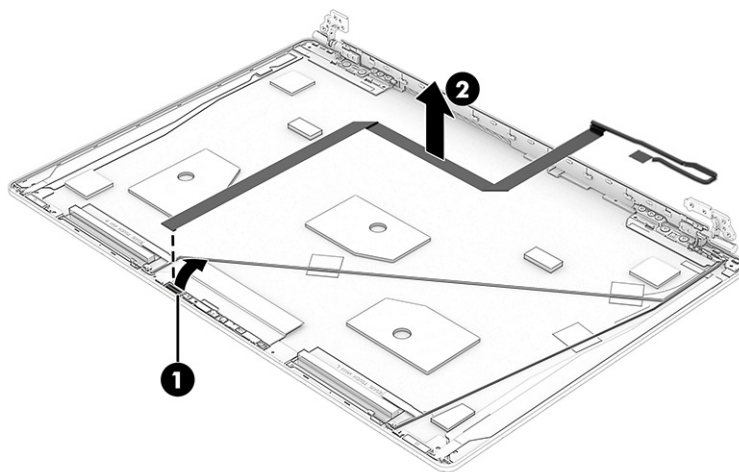

12. To remove the antenna cables, first remove the cables from the tape (1) on the cover, then use a flat tool to pry up and remove the antenna modules (2) off the inside of the display back cover.

Antenna cables are available as part of the cable kit (with antenna) as spare part number P83619-001.

See the [Illustrated parts catalog on page 15](#) for part numbers for the display back covers.

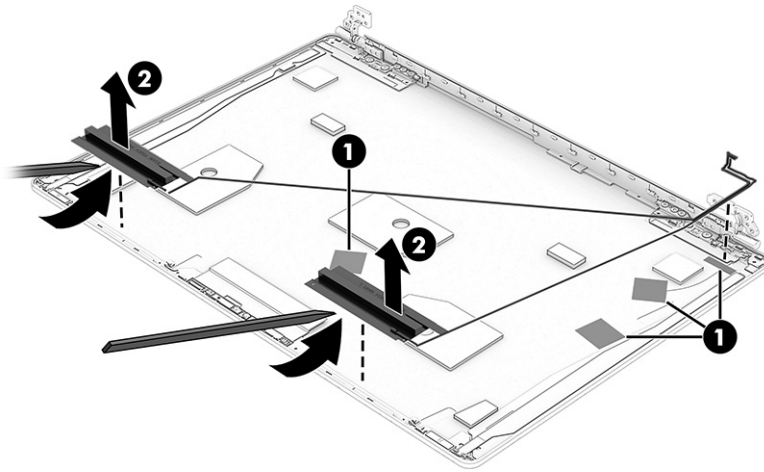

13. To remove the touch control board, peel the black tape (1) off the board and remove it, then disconnect the touch control cable from the touch control board (2).
 - a. Disconnect the cables from the touch control board ZIF connectors (3).
 - b. Use a flat tool to pry up the touch control board (4) and then lift the board away from the back cover (5).

The touch control board is available as spare part number P84442-001 (for AMD processors) and P83635-001 (for Intel processors).

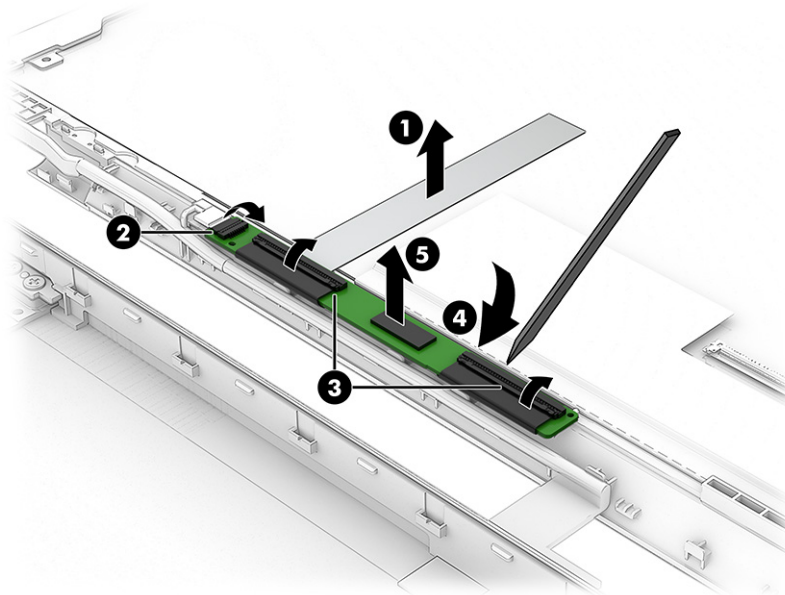

- c. To install a new touch control board, first affix the replacement tape to the control board in the marked section (1) and then affix the tape to the back cover (2).

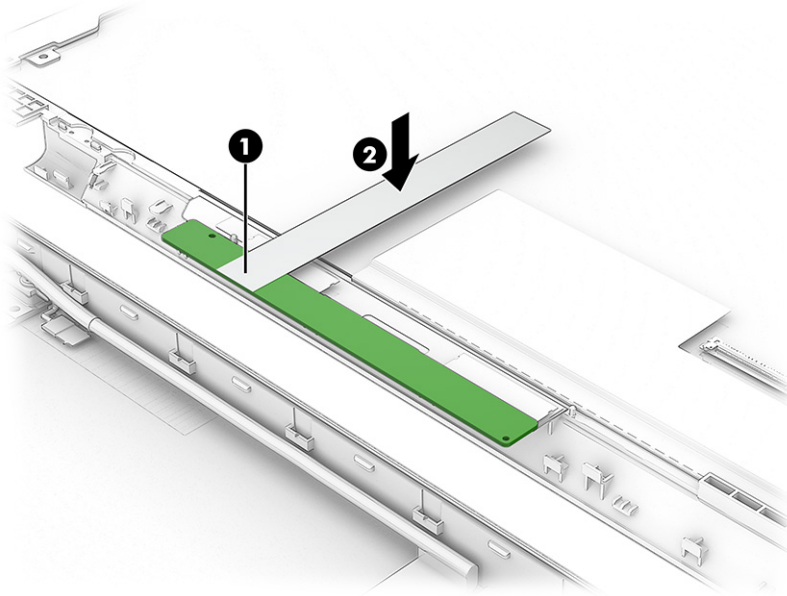

Reverse this procedure to reassemble and replace the display assembly.

Keyboard with top cover

The top cover with keyboard remains after removing all other spare parts from the computer. In this section, the first table provides the main spare part numbers for the top cover with keyboards. The second table provides the country codes.

Table 6-11 Keyboard with top cover descriptions and part numbers

Description	Spare part number
Keyboard with top cover (glacier silver)	P83599-001
Keyboard with top cover (meteor silver)	P83600-001
Keyboard with top cover (silk sand)	P83601-001
Keyboard with top cover (starlit blue)	P83602-001



NOTE: Not all colors are available in all countries.

Table 6-12 Spare part country codes

For use in country or region	Spare part number	For use in country or region	Spare part number	For use in country or region	Spare part number
Belgium	-A41	Hungary	-211	South Korea	-AD1
Bulgaria	-261	Israel	-BB1	Spain	-071
Chile	-161	Italy	-061	Switzerland	-BG1
Czech Republic/Slovakia	-FL1	Japan	-291	Taiwan	-AB1

Table 6-12 Spare part country codes (continued)

For use in country or region	Spare part number	For use in country or region	Spare part number	For use in country or region	Spare part number
Denmark, Finland, and Norway	-DH1	The Netherlands	-B31	Thailand	-281
French Canada	-DB1	Portugal	-131	Turkey	-141
France	-051	Russia	-251	Ukraine	-BD1
Germany	-041	Saudi Arabia	-171	United Kingdom	-031
Greece	-151	Slovenia	-BA1	United States	-001

7 Troubleshooting guide

This chapter primarily focuses on troubleshooting HP Mobile Workstations. The information is provided so that you can solve problems yourself or at least narrow down the number of possible causes.

Based on some of the most common symptoms, this chapter identifies logical steps and available resources or tools for resolving an issue. HP recommends that you follow the instructions carefully, observe safety precautions, and note any observations or results. Capturing this information can help identify and resolve the problem more quickly.

 **WARNING!** To reduce the risk of electric shock or damage to the equipment:

- Do not disable the power cord grounding plug. The grounding plug is an important safety feature.
- Plug the power cord into a grounded (earthed) outlet that is easily accessible at all times.
- Disconnect power from the equipment by unplugging the power cord from the AC outlet.
- Before disassembling notebooks, always disconnect power and remove the battery.

 **IMPORTANT:** Static electricity can damage the electronic components of the computer. To prevent damage to the computer, carefully observe the electrostatic discharge precautions.

- Discharge static electricity by briefly touching a grounded metal object before you begin.
- Work on a static-free mat.
- Wear a static strap to ensure that any accumulated electrostatic charge is discharged from your body to the ground.
- Create a common ground for the equipment that you are working on by connecting the static-free mat, static strap, and peripheral units to that piece of equipment.
- For more information, see [Electrostatic discharge information on page 23](#).

 **IMPORTANT:** The computer includes customer self-repair parts and parts that should be accessed only by an authorized service provider. Accessing parts described in [Removal and replacement procedures for authorized service provider parts on page 41](#) can damage the computer or void the computer warranty.

Resources

Use this table to locate troubleshooting resources.

Table 7-1 Troubleshooting resources and their descriptions

HP Resource Tool	Description	Link
HP Customer Support	Provides important support, such as warranty, support cases, drivers, Customer Advisories, Customer and Security Bulletins, and Product Change Notices.	https://support.hp.com/us-en/contact-hp
Support Alerts	Allows you to sign up for HP product updates.	https://support.hpe.com/hpesc/public/docDisplay?docId=c01139159
HP Support Forums	Provide discussions about HP products and issues.	http://h30434.www3.hp.com/psg/
Vendors' websites	Provide additional information for associated components such as Intel® (processor, WLAN), Microsoft (Windows), AMD®/NVIDIA® (GPU), and so on.	http://www.intel.com/content/www/us/en/homepage.html http://www.amd.com http://www.nvidia.com

General troubleshooting steps

This section helps you become familiar with troubleshooting methodology and efficiently resolve problems.

Proceed through the steps in the following table until the issue is resolved, and then move on to the next step that is relevant to the issue. For example, if you resolve a memory issue using the HP PC Diagnostics, or Unified Extensible Firmware Interface (UEFI), tool in step 6, you can then move on to step 10 to reset the memory into its memory slot.



NOTE: You can ignore troubleshooting steps that do not apply to your issue.

Table 7-2 Troubleshooting methodology and general troubleshooting steps

Identify issue	Analyze issue	Resolve issue	Verify solution
1. Understand the issue on page 66	5. Remove or uninstall recently added hardware, software on page 69	8. Hard reset on page 75	Verify solution on page 79
2. Examine the environment on page 68	6. HP Hardware Diagnostics and Tools on page 70	9. Soft reset (Default Settings) on page 76	
3. Perform a visual inspection of hardware on page 68	7. Status lights, blinking light codes, troubleshooting lights, and POST error messages on page 72	10. Reset cables and connections on page 76	
4. Update BIOS and drivers on page 69		11. Test with minimum configuration on page 77	
		12. Test with verified working configuration (hardware or operating system) on page 78	
		13. Replace the system board on page 78	

Identify the issue

Use these guidelines to correctly determine the problem.

1. Understand the issue

It is important to understand the issue that occurred, including related symptoms. It helps to understand the basic computer startup sequence as well as the failure itself.

Startup sequence

The computer performs several steps after you press the power button or restart the computer.

It is important to understand where in the startup sequence the symptoms occur. The following table lists the phases of the startup sequence and explains the symptoms that might occur in each phase. For example, a blue screen error (BSOD) often occurs during the performance phase.

Table 7-3 Startup sequence and associated failures

Item	Procedure
Startup	<p>After you press the power button, the computer starts after all internal power rails (such as 5 V, 3.3 V) are stable.</p> <p>Confirm that power lights are on and fan is spinning.</p> <p>Common issues: all lights are off; troubleshooting lights are on; computer does not start; video is absent.</p>
POST (UEFI/BIOS)	<p>Power-On Self-Test (POST) verifies that hardware components (such as processor, hard drive, memory) are functional. When POST is complete, the HP logo appears briefly and then disappears.</p> <p>If there are errors, the computer might exhibit blinking lights, POST error messages, or similar notifications.</p> <p>Common issues: lights blink; error message appears; system hangs (lock up or freezes)</p>
Performance (operating system)	<p>System boots to operating system, and Windows logo screen appears.</p> <p>Common issues: hangs, blue screen, distorted video, driver conflict, slow performance, display issue (dead pixel), I/O issue (no speaker sound), wireless/audio unavailable, noise.</p> <p>See Analyze the issue on page 69 table for detailed troubleshooting information.</p>

Failure classification

Failure classification is a breakdown of different types of failures and symptoms that could occur during the boot-up sequence.

[Table 7-4 Failure classification by startup sequence on page 67](#) and [Table 7-5 Failure classification by hardware devices on page 68](#) represent the failure classification for common notebook failures.

[Table 7-4 Failure classification by startup sequence on page 67](#) categorizes failures by the startup sequence.

1. Power-on: Common issues are no power, recycle, or restart.
2. POST: Common issues are no boot (despite power), light flash, or diagnostics error.
3. Performance: Common issues are Intermittent Loss of Power, Blue Screen, Hang. In many cases, issues can be identified and associated with particular hardware (for example, display or storage).

[Table 7-5 Failure classification by hardware devices on page 68](#) categorizes failures by hardware:

- Display
- I/O (input/output) devices

- Storage
- Mechanical

A single symptom can be listed under different groups. For example, No Video can belong to (1) power-on or (4) display; but flickering when turned on should be listed in (4) display. Or, in another example, a blue screen can be caused by a driver conflict in performance (4), but it can also be caused by a defective hard drive under (6) storage. Therefore, failures that share similar symptoms are noted.

If possible, make a record of the failure symptom, the phase of the startup sequence where the failure occurs, and the most likely location in the failure tree ([Table 7-4 Failure classification by startup sequence on page 67](#) and [Table 7-5 Failure classification by hardware devices on page 68](#)). This record helps isolate the issue and indicate the next steps. For example, when the computer is running the operating system, it can experience an issue with (4) display, (5) I/O devices (keyboard, wireless, and so on), (6) storage, or (7) mechanical components (stuck buttons, thermal shutdown, and so on).



NOTE: *Uncategorized* is used if an issue found is not listed. For example, Bluetooth is offered on certain hardware configurations; therefore, you can classify a Bluetooth issue under I/O Device if needed.

Failure classification by startup sequence

Use this table to locate failure classification information.

Table 7-4 Failure classification by startup sequence

1. Power-on	2. POST	3. Performance
1. No power on page 82	1. No video (with power) on page 89	1. Intermittent shutdown on page 92^a
2. Intermittent power-on, shutdown, reboot on page 84^a	2. Blinking lights on page 90	2. Blue screen on page 93^b
3. AC adapter issue on page 85	3. Diagnostics error messages on page 91	3. Freeze at Windows Logo (hang/lockup) on page 95
4. Battery not recognized, not charging on page 85	4. BIOS password on page 91	4. Electromagnetic Interference (EMI) on page 96
5. Battery discharges too fast on page 88		5. No wake up on page 97
6. Burnt smell on page 88		6. Unresponsive on page 98
		7. Slow performance on page 99^c
		8. HP Smart Adapter warning message on page 99
		9. Incorrect time and date on page 100

^{a,b,c} similar symptoms

Failure classification by hardware devices

To determine failure by device, use this table.

Table 7-5 Failure classification by hardware devices

4. Display	5. I/O devices	6. Storage	7. Mechanical
1. Display anomalies on page 101	1. Keyboard on page 107	1. Hard drive or solid-state drive not recognized on page 116	1. Noise (sound) on page 120
2. Dead pixel on page 103	2. Keyboard point stick on page 108	2. No boot to operating system (no read/write error) on page 117	2. Fan runs constantly on page 121
3. No video (internal) on page 103^c	3. Keyboard backlight on page 109	3. Read-write error on page 118	3. Thermal Shutdown on page 122
4. No video (external) on page 103^c	4. Touchpad on page 109	4. Slow performance on page 118^b	
5. DisplayPort/VGA on page 104	5. Network Connectivity Ethernet (RJ-45 jack) on page 110	5. Blue screen (BSOD) error on page 119^a	
6. HDMI on page 104	6. Network connectivity wireless (WLAN) on page 110	6. Noisy hard drive on page 119	
7. No or bad external video via docking on page 105	7. WWAN on page 111		
8. Incorrect or missing color/distorted image on page 105	8. USB on page 111		
9. Touch screen on page 106	9. Smart card reader on page 112		
	10. Speaker, headphone - audio issues on page 113		
	11. Thunderbolt (TB) on page 115		

^{a,b,c} similar symptoms

2. Examine the environment

It is important to examine the computer's environment. If you can quickly identify the cause of the issue, fewer resolution steps might be needed.

Perform the following environment inspections:

- Check all cables and connections to be sure that no connections are loose.
- Confirm that power sources are good, such as AC outlet or adapter (110 V/220 V AC), power strip. Test with a verified working AC outlet.
- Check for compatibility issues between the computer and third-party devices, peripherals, uncertified devices, incompatible hardware (for instance, Mac OS device). Incompatibility can result in blue screen errors, improper operation, and so on.
- Isolate the computer from sources of electromagnetic interference (EMI), such as cell phones, two-way radios, floor mats, fans (and other electronic motors). EMI might contribute to a display freeze issue or lockup.

3. Perform a visual inspection of hardware

Perform a physical inspection of the computer.

- Look for abnormalities such as a cracked display, dented battery, broken latches for battery bay, keyboard key caps popped out, dust over connectors, liquid spill over keyboard.
- Look for signs of drop, movement, or vibration that might cause internal and external loose connections.

4. Update BIOS and drivers

Whenever possible, update to the latest BIOS, firmware, and drivers before troubleshooting.

 **IMPORTANT:** Note that some customer company policies prohibit updates. Check your company policy before taking action.

The updates might include fixes for your computer issues, and they might also enhance system performance. HP continually improves the update process to make it easier. You can update the BIOS locally through a manual process, through an automatic installation, or through a remote installation on multiple units.

Manually updating BIOS and drivers

Use this information to update the BIOS.

- To manually update the BIOS and drivers, see the Setup Utility (BIOS) chapter.
- See the specific BIOS update installation instructions that accompany the download.

Remotely deploying the BIOS and drivers

Instead of manually searching for and downloading each SoftPaq, users and IT personnel can use two tools to identify and download all appropriate SoftPaqs for the selected HP models.

- HP SoftPaq Download Manager (SDM) is a software tool that streamlines the download, extraction, and installation process of SoftPaqs, including BIOS and drivers.
- HP System Software Manager (SSM) is a software tool that simplifies the deployment of SoftPaqs to HP computers.

Analyze the issue

Use these steps to evaluate and interpret the problem.

5. Remove or uninstall recently added hardware, software

HP has designed this computer and validated it using a full-range hardware and software qualification matrix. If an issue appears to have started recently, it might be related to the recent addition of hardware or software.

A good method to determine the root cause is to remove recently added components or uninstall applications one at a time and restart the computer when necessary.

 **IMPORTANT:** After you have completed the process of uninstalling hardware or software and are ready to reinstall, be sure that the new device is seated properly and all cables are correctly connected. After installing the device, restart the computer, and be sure that the new device is turned on. In addition, if the new device is a root cause of a problem, it could cause a conflict in drivers or incompatibility issues with other installed programs. For any new hardware you have added, be sure to install the latest drivers available from the device vendor website.

6. HP Hardware Diagnostics and Tools

HP offers diagnostics and tools to diagnose hardware failure. This section describes how to use some of these tools. Check for the latest versions before use.

HP PC Hardware Diagnostics UEFI

HP PC Hardware Diagnostics is a Unified Extensible Firmware Interface (UEFI) that allows you to run diagnostic tests to determine whether the computer hardware is functioning properly.

The HP PC Hardware Diagnostics UEFI tool is built within BIOS (basic memory and hard drive diagnostics only), or within new hard drives themselves. These drives contain more advanced versions of the diagnostic tool than the BIOS-based version.

In addition, for HP authorized service partners and IT professionals who need to support a mixed environment of older and newer HP/Compaq PCs, the HP PC Hardware Diagnostics Tool (<https://support.hp.com/us-en/help/hp-pc-hardware-diagnostics>) supports a wide range of HP computers.

The tool runs outside the operating system so that it can isolate hardware failures from software issues, whether caused by the operating system or applications. In reality, you can determine many problems using this tool if the issue is a defective part or a loose connection.

The tool has three major functions:

- System Tests check the computer's hardware to verify that everything is functioning properly. If your system won't boot into Windows, try the Quick System Test. For more comprehensive testing, use the Extensive System Test option. If the System Test did not detect a hardware problem, continue with the Component Tests.
 - Component Tests focus on selected hardware components in your computer.
 - Firmware Management updates your computer's BIOS to the latest version (available separately) or rolls back to a previous version.
1. Turn on or restart the computer, quickly press the **esc** key on the computer, and then press **f2**.

The BIOS searches three places for the diagnostic tools, in the following order:

- a. Connected USB drive
 - b. Hard drive
 - c. BIOS
2. When the diagnostic tool opens, use the keyboard arrow keys to select the type of diagnostic test you want to run, and then follow the on-screen instructions.

Screen capture appearance might vary.

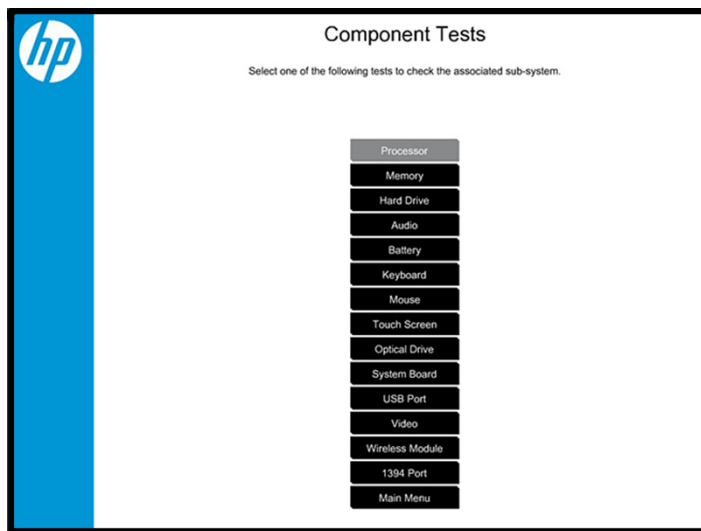
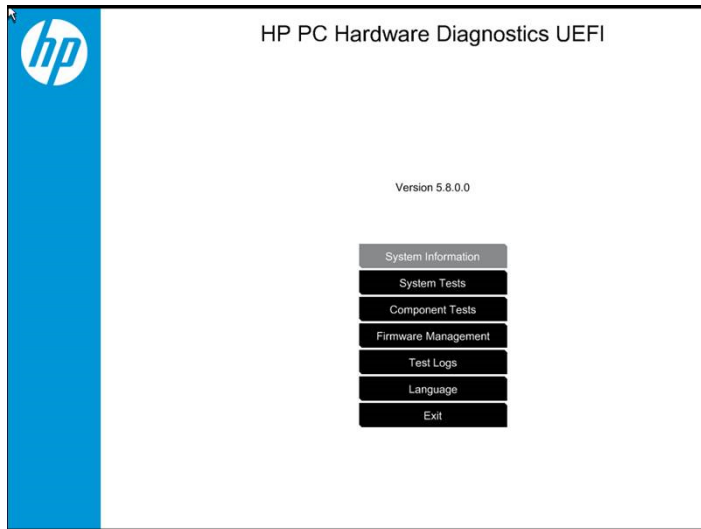

 **NOTE:** Using this tool can be especially helpful when the computer cannot boot to Windows.

 **NOTE:** If a component fails a test, write down the information so that it is available when you contact support. The information is also available in **Test Logs** on the Main Menu.

For more information, see [Using HP PC Hardware Diagnostics on page 151](#).

HP BIOS Configuration Utility (BCU)

HP BCU is a free utility that captures the BIOS settings and their values. This tool provides a text file of the computer's BIOS configuration. This file can help identify any settings that are contributing to an issue.

In some cases, it might help to compare this BIOS text file to the default settings of the computer.

For more information, see

http://ftp.hp.com/pub/caps-softpaq/cmit/whitepapers/BIOS_Configuration_UTILITY_User_Guide.pdf.

 **NOTE:** HP recommends that you reset BIOS before trying BCU. Resetting the BIOS is always available and relatively quick to try, whereas BCU takes extra time and effort.

HP Image Diagnostic Tool

Available to HP Authorized Support Partners (ASPs) and users, this tool collects information about the current state of the computer, including product serial number, platform and BIOS information, and information about user-installed software and hardware components.

Access this tool at <ftp://ftp.hp.com/pub/idr/ImageDiags/>. HP encourages you to review the report before sending it to support. The report can assist you with diagnostics and solutions to problems you encounter.

HP Thermal Monitor

You can use HP Thermal Monitor to stress the processor and GPU and monitor the temperature values of various components in the system.



NOTE: Available only to authorized service providers and technicians.

The components that are currently monitored include the processor, GPU, ACPI thermal zones, hard drive, and battery. The tool reads the temperatures of the components, logs the data, and helps to determine whether the computer would overheat in the event of thermal shutdown, fan spinning loud, and so on.

Non-HP diagnostics tools

Refer to the following diagnostic tools for troubleshooting help.

Windows-To-Go USB

Windows-To-Go USB is a Microsoft-based tool for Enterprise editions of Windows that can help in troubleshooting. You can find a process online about how to create a live Windows USB drive.

Intel Processor Diagnostic Tool

Determine what processor is in your computer and verify the processor operating frequency. The tool also tests specific processor features and performs a stress test on the processor. For more information, see

http://www.intel.com/support/processors/sb/CS-031726.htm?iid=subhdr+tools_procdiagtool.

7. Status lights, blinking light codes, troubleshooting lights, and POST error messages

Carefully observe any behavior that the computer is exhibiting: status lights, blinking lights, and POST error messages during boot. It is important to understand what these indicators mean.

Status lights

The following table describes basic lights on the computer.

Table 7-6 Power button functions and lights and their descriptions

Component	Description
Power button	<p>When the computer is off, press the button to turn on the computer.</p> <p>When the computer is on, press the button briefly to initiate Sleep (Windows) or Suspend (Linux®).</p> <p>When the computer is in the Sleep state, press the button briefly to exit Sleep (Windows) or Suspend (Linux).</p> <p>When the computer is in Hibernation, press the button briefly to exit Hibernation.</p> <p>IMPORTANT: Pressing and holding down the power button results in the loss of unsaved information.</p> <p>If the computer stops responding and operating system shutdown procedures are ineffective, press and hold the power button.</p>
Front power light	<p>On: The computer is on.</p> <p>Blinking: The computer is in the Sleep state.</p> <p>Off: The computer is off.</p>
Front AC adapter and battery light	<p>White: The computer is connected to external power, and the battery is charged from 90% to 99%.</p> <p>Amber: The computer is connected to external power, and the battery is charged from 0% to 90%.</p> <p>Blinking amber: A battery that is the only available power source has reached a low battery level. When the battery reaches a critical battery level, the battery light blinks rapidly. By default, the critical battery level is defined in Power Options as 5%.</p> <p>Off: The battery is fully charged.</p>
Front hard drive light	<p>Blinking white: The hard drive is being accessed.</p> <p>Amber: HP 3D DriveGuard has temporarily parked the hard drive.</p>
Rear AC adapter light	<p>White: The computer is connected to external power.</p> <p>Off: The computer is not connected to external power.</p>

Blinking light codes

During startup, the computer might not start properly. If this occurs, blinking light codes can help identify the cause.

The computer uses the following blinking lights to identify a hardware component that reports an error during startup. For more information, see [Blinking lights and boot error codes on page 123](#).

Table 7-7 Blinking light codes and what they mean

Blink codes	Error
Amber battery light: blinks 1 Hz continuously	Embedded controller unable to load firmware
Caps and num lock lights = 1 blink	Processor not executing code
Caps and num lock lights = 2 blinks	BIOS recovery code unable to find valid BIOS recovery image
Caps and num lock lights = 3 blinks	Memory module error
Caps and num lock lights = 4 blinks	Graphics controller error

Table 7-7 Blinking light codes and what they mean (continued)

Blink codes	Error
Caps and num lock lights = 5 blinks	System board error
Caps and num lock lights = 6 blinks	Intel Trusted Execution Technology (TXT) Error
Caps and num lock lights = 7 blinks	Sure Start unable to find valid BIOS Boot Block image
Caps and num lock lights = 8 blinks	Sure Start has identified a problem (Manual Recovery Policy Set)

POST error messages

The Power-On Self-Test (POST) is a series of diagnostic tests that runs automatically when the computer is turned on. If the POST encounters a problem, visual error messages are displayed before the operating system starts.

POST checks the following items to ensure that the computer system is functioning properly:

- Memory
- Processors
- BIOS
- Mass storage devices
- Fans

The following table describes errors encountered during HP PC Hardware Diagnostics UEFI.

Table 7-8 System diagnostics failure codes and actions to address the failure

Test description	Failure description	Error code	Suggested user actions
Startup Test	Memory module	200	Attempt to reseat the memory module, and then repeat the test. For details on troubleshooting issues related to the memory module, search for support documentation at http://www.hp.com/support .
Startup Test	Hard Disk 1 SMART	301	Attempt to reseat the hard drive, and repeat the test. The hard drive might have failed.
Boot Device Manager	Boot device not found	3F0	Reset BIOS. Then reseat the hard drive, and repeat the test.
BIOS Recovery	BIOS Recovery Occurred	500	This message indicates that BIOS recovery was completed successfully. No further action is required.
BIOS Application	BIOS Application Error	501	The BIOS installation might have become corrupted. Download the latest version of the BIOS and install it. If reinstalling the BIOS fails, contact support for further assistance.
CMOS Recovery	CMOS Recovery Occurred	502	This message indicates that CMOS recovery was completed successfully. No further action is required.

Table 7-8 System diagnostics failure codes and actions to address the failure (continued)

Test description	Failure description	Error code	Suggested user actions
Battery Check	Primary Battery Replace	601	This message indicates that the primary battery has very low capacity. Search for support documentation at http://www.hp.com/support for details on using the HP Support Assistant to verify the battery capacity and, if necessary, order a replacement.
Wireless Modules	Not installed or responding	701	Reseat the wireless LAN adapter module and antennas. Because seating or reseating a wireless LAN adapter is unique to each computer model, see the WLAN module removal section in the removal and replacement chapter for further details. Contact support if third-party wireless adapters are installed in the computer.
Fan	Fan not operating correctly	90B	The system fan might be malfunctioning. Replace the fan.

Resolve the issue

The following sections help you fix the issue.

8. Hard reset

A hard reset (or forced reset) erases all information in the computer's memory and might restore functionality. Resetting the computer forces the system to clear and reestablish the connections between the BIOS and the hardware.

Performing a hard reset might fix the following common conditions:

- Windows stops responding.
- Computer stops before Windows loads, indicated by incomplete startup, blinking cursor on a black background, and errors relating to operating system not found or a missing drive.
- Display suddenly goes blank and stays blank.
- Software freezes.
- Keyboard stops responding.
- The computer does not exit Sleep or Suspend state.
- An external device stops responding. Turn off the power to that device in addition to performing the steps in this document.

Before performing a hard reset, you must disconnect or remove all peripheral devices. Start and test the computer by itself, and if the problem is not resolved, reconnect one peripheral device at a time. To resolve the startup or operational problem, run HP Support Assistant, or manually install all updated drivers from Microsoft and HP.

Before beginning, turn the computer over and look for a battery compartment door or service door. On some platforms, the battery is considered removable but not accessible.

1. Turn off the computer.

2. Remove the computer from any port replicator or docking station.
3. Disconnect all external connected peripheral devices such as USB storage devices, external displays, and printers.
4. Unplug the AC adapter from the computer.
5. Disconnect the battery.
6. Press the power button + **Windows logo**  + **V**.
7. Reconnect the battery and plug the AC adapter back into the computer, but do not connect any of the peripheral devices.
8. Press the power button to turn on the computer.
9. If a startup menu appears, use the arrow keys to select **Start Windows Normally**, and then press the **enter** key.
10. After reconnecting each of the peripheral devices, run Windows Update and HP Support Assistant to update all device drivers.

CMOS refers to the battery-powered semiconductor chip located on computer's system board. Notebooks store low-level settings like the system time and hardware settings in CMOS. Sometimes you must clear CMOS, which requires removing and reinserting the 3 V RTC battery for a short time (a few minutes before reinserting), in addition to removing the AC adapter and battery.

 **NOTE:** Clearing the CMOS should only be performed for troubleshooting purposes. There is no reason to clear CMOS if the computer is working properly.

You must remove the notebook service door to access the CMOS battery. If the computer has a replaceable RTC battery, see the RTC battery replacement section for the battery removal or replacement.

9. Soft reset (Default Settings)

If your computer has issues starting up, has errors during startup, has issues after you add hardware, or has other abnormal system behaviors that you cannot resolve through any other methods (for example, hard reset), it might be necessary to reset the system BIOS to default settings.

 **NOTE:** Some company policies prohibit updates or changes. Check whether the computer has custom BIOS settings before taking action.

To load BIOS to default settings: Restart the computer, and then press **f10 > Main > Restore defaults**. For more information, see <http://support.hp.com>, and then search for **BIOS Setup Utility Information and Menu Options**.

10. Reseat cables and connections

Many problems are caused by improper connections or loose connections because of abnormal movement and vibration.

 **NOTE:** Before disassembling the computer to reseat cables and connections, always disconnect power and remove the battery, or disconnect a nonremovable battery.

See [Cable management on page 134](#) and [Connector types on page 135](#) for suggested cable management practices when you remove and install components.

You can access and reseat connections for Customer Self-Repair (CSR) parts. Examples of reseating hardware include:

- Reseating the battery into the battery bay can resolve no-battery found and no-charging issues.
- Reseating memory modules can resolve memory error, startup, and blue screen issues.
- Reseating the hard drive can resolve a POST error 3F0 (no boot device) issue (see [POST error messages and user actions on page 126](#)).
- Reseating the keyboard cable can resolve an unrecognized keys error.
- Reseating the wireless module and antenna cable can resolve a wireless connection issue.

For field replaceable units (FRUs), authorized service providers can try the following steps. For more information, see [Removal and replacement procedures for authorized service provider parts on page 41](#).

- Reseating the fan cable can fix POST error 90B (no fan detected) issue (see [POST error messages and user actions on page 126](#)).
- Reseating the power cable can fix a startup issue.
- Reseating the daughterboards can resolve their functional issues. Some models might have other items such as a power button board or VGA board.
- Reseating graphics cables and panel connectors can fix distorted or flickering video.
- Replacing thermal pads might resolve thermal power-down issue.

11. Test with minimum configuration

The factory-shipped computer (hardware configuration and preinstalled operating system image) is well tested and ready for use. Therefore, using the original factory hardware configuration or booting to operating system safe mode often resolves issues quickly.

- Disconnect any external USB storage, remove any discs in optical drives, remove the computer from a docking station, remove external video, and others.
- In addition to removing recently added components, you can narrow the issue down further with a minimum configuration. For example, if HP PC Diagnostics reports a memory error, test one memory module at a time to isolate the defective module.
- If the computer does not successfully boot the operating system, booting to safe mode might help identify the following possible causes of the issue.

Essential hardware configuration

If none of the previous steps resolve the issue, start the computer with essential hardware only. The purpose is to remove as much hardware as possible while still maintaining the computer's ability to turn on.



NOTE: This step is to be used by authorized service providers only. HP will not honor the warranty for a system tested with the system board removed without the heat sink or fan.

This essential configuration is often used to troubleshoot power-on related issues, such as no-boot, reboot, and freezing issues.

The essential hardware consists of the following components:

- System board
- AC adapter (unplug nonremovable battery or remove battery)
- Processor and heat sink or fan

The processor might be integrated into the system board.

- Memory (one verified working memory DIMM)
- Graphics card, if no VGA port is available on the system board

Platform might have both Intel integrated graphics and discrete graphics. Therefore, you might not need a discrete graphics card.

- External VGA monitor
- External USB keyboard
- External mouse



NOTE: After you remove the service door, disconnect all connections (internal keyboard, display, discrete GPU, hard drive or SSD, daughterboards, and so on) to achieve the essential hardware configuration. **Do not** disassemble the system board from its enclosure at this time.

Reverse the previous procedure by reinstalling each piece of hardware removed, one piece at a time, and testing your computer after each installation. Because your computer works with only the essential hardware installed, those parts must be working properly. This means that one of the hardware components removed is causing the computer to fail. By installing each device back into the computer and testing each time, you eventually identify the failing hardware.

Safe mode

A driver conflict often results in a blue screen error message. Starting in safe mode can resolve many issues in Windows because safe mode forces the computer to load a limited version of Windows which contains only essential files.

Safe mode is useful for troubleshooting problems with programs and drivers that might not start correctly or that might prevent Windows from starting correctly. If a problem does not reappear when you start in safe mode, eliminate the default settings and basic device drivers as possible causes.

12. Test with verified working configuration (hardware or operating system)

One troubleshooting technique that can quickly isolate an issue is using a verified working part while testing. A good example is to use an external keyboard, mouse, or VGA monitor when you have issues with an internal keyboard, touchpad, or display.

Testing with a verified working AC adapter can identify an error caused by a faulty one. Similarly, testing with a verified working operating system can determine bad behaviors of the current operating system.





NOTE: In some situations, more than one item might contribute to a problem.

13. Replace the system board

Only authorized service providers may replace the system board. This should not be considered an initial step taken to resolve an issue.

Review and perform all steps discussed previously before replacing the system board. [4. Update BIOS and drivers on page 69](#), [7. Status lights, blinking light codes, troubleshooting lights, and POST error messages on page 72](#), [8. Hard reset on page 75](#), and [9. Soft reset \(Default Settings\) on page 76](#), or [10. Reseat cables and connections on page 76](#) can resolve many system board issues without requiring the effort of replacing unnecessary hardware.

 **IMPORTANT:** System board failure is not common. Do not replace the system board until you have tried all other troubleshooting options.

 **NOTE:** Determine whether a previous service case might be related to the current problem. For example, a fan detection issue could be caused by a loose connection resulting from previous service.

 **TIP:** Without an RTC battery (3 V coin-cell battery), the computer automatically reboots. This feature is useful when the power connector cable (between external AC adapter and system board) is defective.

 **NOTE:** Most of the time, effective troubleshooting can prevent a system board replacement.

Situations that can prevent resolution of the issue:

- The information provided about the issue omits key details, including any actions taken before the issue occurred.
- BIOS, software, and drivers have not been updated.
- Cables or connections are loose.
- Technician is unaware of information available from the HP Support website (CA - Customer Advisory).
- The issue is related to existing or known issues that might be identified in existing support articles.
- Technician might have omitted steps in the provided repair instructions (for example, Spare Part Replacement Instructions).
- Skipping one of the steps from the Troubleshooting Methodology table results in No Defect Found (NDF)/No Fault Found (NFF)/No Issue Detected (NID) messages.

Verify solution

Confirm that the implemented solution works.

- Reboot the system or device, and try to complete the task that produced the issue.
- If a part has been replaced, verify other basic functions. For example, GPU replacement requires keyboard removal. Therefore, it is good practice to verify all basic components to be sure that the solution is complete.
- Explain to the customer why the issue occurred and what was done to resolve it. If the solution you used was in an HP public document, provide the document information to the customer, letting them know they can locate it on <http://www.hp.com>. Also, tell them that there are other solutions available on the website. Advise the customer to check the website first when they have an issue. It might save them time calling in.
- Document the correct issue. Update the case with as many details as possible for other agents and engineers to analyze and study for lessons learned.

Helpful Hints

After you become familiar with the troubleshooting steps, use the helpful hints before running diagnostics and troubleshooting.

At startup

These steps provide simple, useful checks that you can perform when troubleshooting.

 **TIP:** If you have installed an operating system other than the factory-installed operating system, go to <http://www.hp.com/go/quickspecs> and verify that it is supported on your system.

1. Be sure that the computer is plugged into a working AC outlet.
2. Be sure that power is connected to the docking station if you use a dock.
3. Be sure that the AC adapter light is on.
4. Be sure that the AC adapter is connected when you update BIOS to avoid BIOS corruption.
5. Be sure that the computer is turned on, the rear power light is solid white (connected to an external power source), and the front power light is solid white (normal operation).
6. Remove all optical and flash drives from your system before turning it on.
7. Be sure that the boot option is set to a working operating system drive.
8. Be sure that externally connected monitors are turned on and their power lights are on. Not all monitors are equipped with lights to indicate their functionality.
9. Turn up the brightness and contrast controls of a display or external display device if the screen is dim.

During operation

The following steps provide simple, useful checks that you can perform when troubleshooting.

1. To wake the computer:
 - a. Press the power button or any key on the keyboard.
 - b. If the system remains in the Sleep (Windows), Suspend (Linux), or Hibernate state, shut down the system by pressing and holding the power button for at least four seconds.
 - c. If the system does not shut down, unplug the power cord, wait a few seconds, and then plug it in again. Press the power button again to restart the system.
2. Look for blinking lights on the computer. The blinking lights could be error codes that help diagnose the problem.
3. Check all cables for loose or incorrect connections, such as external devices, power cords, or docking stations.
4. After installing a non-Plug and Play expansion board or other option, reconfigure the computer. For example, if you upgrade to an SSD, you might have to reconfigure the boot order.
5. Be sure that all required device drivers have been installed. For example, if you have connected a printer, you must install a printer driver.

6. If there is a network connection issue, plug another computer with a different cable into the network connection. There might be a problem with the network plug or cable.
7. If hardware has recently been installed, remove it and determine whether the computer functions properly.
8. If software has recently been installed, uninstall it and determine whether the computer functions properly.
9. If the screen is blank, confirm the display choice by pressing **Windows logo**  + **p** and set to screen only. You can also plug an external monitor into a different video port on the computer, if one is available, and close the computer lid.
10. Verify that the latest version of BIOS, drivers, and software are installed. A new release might support new features or fix the problem.
11. Press the **caps lock** or **num lock** key. If the **caps lock** or **num lock** light toggles on or off, the keyboard is likely operating correctly.
12. Press the touchpad On/Off button light. If the light toggles on or off, the touchpad is likely operating correctly.

Consulting with HP Service

If further HP support is required, the following information might be requested when you call. It might be helpful to take notes.

- Technical support registration number (if applicable)
- Product serial number
- Product model name and number
- Product identification number
- Applicable error messages
- Add-on boards or hardware
- Third-party hardware or software
- Operating system type and revision level
- Description of symptom or failure

Common issues and possible solutions

This section contains common issues, symptoms, and a series of tables that describe possible solutions to issues from Failure Classification tables. The following sections identify the issue with symptoms and solutions to resolve an issue.

Power-on issues

Use the following sections to troubleshoot power issues.

No power

When a unit experiences no power, there are several contributing factors to consider. Be sure to consider all symptoms related to this behavior when troubleshooting.

Table 7-9 Issues, possible causes, and fixes

Items	Procedures
<i>Symptoms</i>	<i>Possible causes</i>
<ul style="list-style-type: none">• Computer does not start• Display is black or blank• No fan noise• No hard drive spinning• Lights do not glow	<p>Failed power input to the computer (external power source, AC adapter, faulty battery).</p> <p>Bad connection to the computer (bad power button, power connector).</p> <p>Defective parts (memory, hard drive, graphics) or failed system board.</p>
	<i>Troubleshooting steps</i>
	Perform quick check
	Remove all external devices, including docking station.
	Verify external power source (2. Examine the environment on page 68).
	Perform a hard reset (8. Hard reset on page 75).
	Verify AC adapter
	Verify the battery before verifying the AC adapter. However, you can verify the AC adapter first, before opening the service door for a battery check.
	<ul style="list-style-type: none">• Verify AC adapter is compatible with product. Verify that the part number is for this computer if possible.• Verify AC adapter and power cord are good (no physical damage, bent middle ID pin).• Verify AC adapter works on a verified working computer.• Plug in AC adapter and power on computer without battery.• Inspect power port on computer side for any damage, dust, or debris.• Check power light (7. Status lights, blinking light codes, troubleshooting lights, and POST error messages on page 72). Rear power light indicates external power to the computer is good.

Table 7-9 Issues, possible causes, and fixes (continued)

Items	Procedures
	<p>Verify battery condition and status</p> <ol style="list-style-type: none"> 1. Check battery condition (overall result, cycle life, voltage) using HP PC Hardware Diagnostics UEFI tool. 2. Verify that battery is installed properly in battery bay without a gap and that latch locks are tight (for models with removable batteries). 3. Check battery status light (7. Status lights, blinking light codes, troubleshooting lights, and POST error messages on page 72). Be sure that battery is not fully discharged, preventing system from booting. 4. Determine whether the computer can turn on with battery only. 5. Remove service door and test with a verified working battery. If the computer boots, inspect original battery before replacement. 6. Test battery with a verified working computer to verify that it works. 7. If the computer still does not boot, remove battery and boot on AC power only.
	<p>The following steps are for authorized providers or technicians.</p>
	<p>Verify AC adapter voltage</p> <ol style="list-style-type: none"> 1. Measure DC voltage output, which should be approximately 19.5 V DC. Acceptable voltage range is from 18.5 to 20.5 V DC. 2. If the DC voltage is out of range, replace the AC adapter. <p>NOTE: This action requires a digital voltmeter.</p>
<p>NOTE: Select models include a power cable between the system board and chassis power connector.</p> 	<p>Verify power button, power connector</p> <ol style="list-style-type: none"> 1. Be sure that power button is not stuck. 2. Reseat power connector cable (if applicable). 3. Replace new power connector cable (if the cable exists and is defective) 4. To isolate faulty power connector cable and power button, technicians can short power-on pads or pins to turn on the computer. Contact HP Engineering for this information.
	<p>Verify blinking lights (7. Status lights, blinking light codes, troubleshooting lights, and POST error messages on page 72)</p> <p>At this point, there should be sufficient power from the AC adapter to the system board. Expect to hear the fan spinning and see blinking lights or error messages (for example, faulty memory, HDD).</p>
	<p>Verify system board</p> <ol style="list-style-type: none"> 1. Test essential hardware configuration (11. Test with minimum configuration on page 77, 12. Test with verified working configuration (hardware or operating system) on page 78, 13. Replace the system board on page 78) by removing nonessential parts. 2. If the computer still does not boot, replace system board.

Table 7-9 Issues, possible causes, and fixes (continued)

Items	Procedures
Tips	<p>Computer automatically boots without pressing power button when the RTC 3 V battery is removed. Therefore, after the service door and RTC 3 V battery are removed, you do not have to press power button from top side.</p> <p>In essential hardware configuration, mWS G1 and G2 might require discrete graphics processing unit (GPU) to boot. However, mWS G3 can boot with integrated graphics.</p>

Intermittent power-on, shutdown, restart

Use this information to troubleshoot power-on, shutdown, and restart issues.

Table 7-10 Issues, possible causes, and fixes

Items	Procedures
<i>Symptoms</i>	<i>Possible causes</i>
<ul style="list-style-type: none">• Does not always turn on• Intermittently hangs• Intermittently shuts down• Spontaneously restarts	<p>Electrical short, fluctuating power source, unstable power rails, loose connections, bent pins, stray wires, dust, obvious damage, nearly faulty parts (bulging or leaking capacitor).</p> <p>Potentially turn into a no-power issue (No power on page 82).</p>
	<i>Troubleshooting steps</i>
	<ol style="list-style-type: none">1. Visually check power ports on both AC adapter and computer sides.2. Inspect power sources:<ol style="list-style-type: none">a. Verify that the AC adapter is working correctly. Use a confirmed working adapter to test.b. Verify that battery is not depleted while system is in the Sleep state. Test with a confirmed working battery.
	The following steps are for authorized providers or technicians.
	<ol style="list-style-type: none">1. Follow actions in No power on page 82.<ol style="list-style-type: none">a. Be sure that AC adapter has correct DC voltage.b. Verify battery: test with a confirmed working battery.c. Verify that power button is not stuck.d. Verify that power connector is not loose.e. Remedy loose connections and reseat major components (processor, memory, GPU, hard drive, SSD, and others).2. Perform visual check for loose connections, bent pins, stray wires, dust, nearly faulty parts (bulging or leaking capacitor).3. Test essential hardware configuration (11. Test with minimum configuration on page 77)<ol style="list-style-type: none">a. If system starts, reinstall nonessential hardware one component at a time to isolate issue.b. If system does not start, replace essential hardware with verified working parts, one component at a time. If system still does not start, replace system board.

AC adapter issue

Use this information to troubleshoot AC adapter issues.

Table 7-11 Issues, possible causes, and fixes

Solution	
<i>Symptoms</i>	<i>Possible causes</i>
<ul style="list-style-type: none">• No sign of power	AC adapter and others (for example, external power source).
<ul style="list-style-type: none">• No boot	<i>Troubleshooting steps</i>
<ul style="list-style-type: none">• No rear power light	Quick check
<ul style="list-style-type: none">• No front power light	<ol style="list-style-type: none">1. Verify external power source (2. Examine the environment on page 68).
<ul style="list-style-type: none">• Battery does not charge when AC adapter is connected	<ol style="list-style-type: none">2. Remove all external devices, including docking station.3. Perform a hard reset for the computer (8. Hard reset on page 75).4. Disconnect and reassemble the power cord and adapter in case the adapter experienced short circuit, over current, over temperature events.5. Use a verified working adapter. If the computer operates normally, there is a problem with the original adapter.6. Verify that the AC adapter works on a verified working computer. If the computer operates normally, there is no problem with the adapter. See HP Smart Adapter warning message on page 99 for further information.
	Verify AC adapter
	<ol style="list-style-type: none">1. Remove working battery.2. Verify that AC adapter is compatible with product. Verify that part number is for this computer if possible.3. Inspect AC adapter and power cord for physical damage, bent middle ID pin.4. Plug in AC adapter and power the computer without battery.5. Inspect the power port on computer side for any damage, dust, debris.6. Check power light (7. Status lights, blinking light codes, troubleshooting lights, and POST error messages on page 72). Rear power light indicates that external power to the computer is good.7. If there is still no rear power light or no startup, replace the AC adapter.
Tips	<p>The HP Smart AC adapter has a special pin in the middle, called the ID pin, for power rating and throttling. If this pin is broken, the rear power light turns on, but the power button and front power lights blink continuously, and the computer does not turn on. Third-party AC adapters do not work with the computer.</p> <p>Use the AC adapter that came with the computer for better performance.</p>

Battery not recognized, not charging

Use this information to troubleshoot battery issues.

Table 7-12 Issues, possible causes, and fixes

Items	Procedures
<i>Symptoms</i>	<i>Possible causes</i>
<ul style="list-style-type: none">• No battery status light• Blinking amber (critically low battery level)• No startup without AC adapter	Defective AC adapter, battery, or both. NOTE: Before proceeding, verify that the computer can start to BIOS or Windows with a good AC adapter.

Table 7-12 Issues, possible causes, and fixes (continued)

Items	Procedures
	<p data-bbox="644 254 855 287"><i>Troubleshooting steps</i></p> <p data-bbox="644 304 818 338">Visual inspections</p> <ol data-bbox="644 354 1449 533" style="list-style-type: none"><li data-bbox="644 354 1182 388">1. Inspect battery connectors for any signs of damage.<li data-bbox="644 405 1449 459">2. Verify that battery is installed properly in battery bay without gap or obstructions and latch locks are tight. Reseat battery (for models with removable batteries).<li data-bbox="644 476 1449 533">3. Determine whether battery gets hot (batteries heat up when charging, but not too hot to touch). <p data-bbox="644 550 1422 606">Check battery warranty to see whether the battery is new or its warranty is expired. Battery capacity degrades over time.</p> <p data-bbox="644 623 932 657">Verify front battery status light</p> <ol data-bbox="644 674 1283 758" style="list-style-type: none"><li data-bbox="644 674 1150 707">1. Battery status light is off: battery not recognized.<li data-bbox="644 724 1283 758">2. Battery status light is blinking amber: critically low battery level. <p data-bbox="644 774 703 808">Reset</p> <ol data-bbox="644 825 1187 909" style="list-style-type: none"><li data-bbox="644 825 1034 858">1. Hard reset (8. Hard reset on page 75)<li data-bbox="644 875 1187 909">2. Soft reset (9. Soft reset (Default Settings) on page 76) <p data-bbox="644 926 815 959">Verify AC adapter</p> <ol data-bbox="644 976 1430 1230" style="list-style-type: none"><li data-bbox="644 976 1430 1083">1. Determine whether the computer needs the AC adapter to boot and operate. Sometimes, an intermittently bad AC adapter and loose connection between adapter and computer results in inability to charge battery, which causes short run time.<li data-bbox="644 1100 1150 1134">2. Inspect AC adapter to verify that it is functioning.<li data-bbox="644 1150 1366 1184">3. Test with a working AC adapter and confirm whether battery is charging.<li data-bbox="644 1201 1418 1234">4. Be sure that battery is fully charged (AC adapter plugged in at least 2.5 hours). <p data-bbox="644 1247 1461 1304">Diagnostics: HP tools report results such as passed, calibrate, weak, replace, no battery, and unknown, and they suggest corresponding actions.</p> <p data-bbox="644 1320 1445 1377">HP PC Hardware Diagnostics UEFI is a good tool to use to isolate and determine faulty battery, especially for quickly discharging (short life) battery.</p> <ol data-bbox="644 1394 1461 1677" style="list-style-type: none"><li data-bbox="644 1394 1123 1428">1. Verify that battery is recognized and charging.<li data-bbox="644 1444 1445 1501">2. Verify battery condition if battery cycle life is past its life expectancy (that is, past 1000-cycle life and 3-year warranty). Battery might need to be replaced.<li data-bbox="644 1518 1461 1575">3. If issue remains, test with a verified working battery and verify battery status lights and battery conditions.<li data-bbox="644 1591 1054 1625">4. If issue remains, replace system board.<li data-bbox="644 1642 954 1675">5. Verify the new replacement.
Tips	See the computer user guide for instructions regarding battery maintenance and increasing battery life.

Battery discharges too fast

Use this information to troubleshoot battery issues.

Table 7-13 Issues, possible causes, and fixes

Items	Procedures
<i>Symptoms</i>	<i>Possible causes</i>
Battery has good status light but discharges too fast	AC adapter, battery, or both.
	<i>Troubleshooting steps</i>
	Verify AC adapter Determine whether the computer needs the AC adapter to boot and operate. Sometimes an intermittently bad AC adapter and loose connection between adapter and computer results in the inability to charge the battery and causes short runtime. <ol style="list-style-type: none">1. Inspect AC adapter to verify that it is working.2. Test with AC adapter alone and with a verified working AC adapter.
	Verify battery: Because battery capacity can degrade over time, check the warranty coverage. Run a battery test to confirm whether issue is hardware related. <ol style="list-style-type: none">1. Review battery power plans in Control Panel > Power Options that might consume more energy and discharge battery faster. Resetting default to Power Saver option can conserve battery power.2. Determine whether any graphics are processing.3. Verify battery maintenance and operations. Leaving the battery at a high level of charge in a high-temperature environment for extended periods accelerates the loss of capacity.4. Test and calibrate battery using HP PC Hardware Diagnostics UEFI.5. Verify battery life cycle using HP Support Assistant tool. If battery cycle life is past its life expectancy (past the 1000-cycle life and 3-year warranty), the battery might need to be replaced.6. Compare discharge time with a verified working battery (remove AC adapter) using Hardware Diagnostics UEFI>Hard Drive Tests>Extensive Test>Loop until error.
Tips	To conserve battery power, turn off Wireless On-Off button and other peripherals and USB devices, applications, processes (in Task Manager) when not in use; also, reduce screen brightness. Follow HP instructions about how to maintain battery and increase battery life.

Burnt smell

Use this information to troubleshoot burnt-odor issues.

Table 7-14 Issues, possible causes, and fixes

Items	Procedures
<i>Symptoms</i>	<i>Possible causes</i>
Emits smoke, burnt smell	Defective on-board components.
	<i>Troubleshooting steps</i>
	General visual inspection
	<ol style="list-style-type: none">1. Disconnect the computer from power source (AC adapter and battery).2. Inspect for visual damage on AC adapter and battery. Test on a known working computer to isolate issue. If issue follows AC adapter or battery, replace it.3. Inspect any sign of liquid spill on the computer (back of keyboard).
The following steps are for authorized providers or technicians.	
	Further inspection on components
	<ol style="list-style-type: none">1. Inspect further sources internally after disassembling chassis, such as burnt or damaged components.2. If the issue persists, replace boards, AC adapter, and battery for safety concern, and report issues to HP.

POST

Use the following sections to troubleshoot Power-on Self Test issues.

No video (with power)

Use this information to troubleshoot video issues.

Table 7-15 Issues, possible causes, and fixes

Items	Procedures
<i>Symptoms</i>	<i>Possible causes</i>
<ul style="list-style-type: none">• No video (black or blank image) but have power	Failed display Failed critical components (memory, hard drive, system board)
<ul style="list-style-type: none">• Light activity	Loose connection
<ul style="list-style-type: none">• No error messages	Recently added hardware
<ul style="list-style-type: none">• Fan noise	
<ul style="list-style-type: none">• Hard drive light blinking and hard drive noise	NOTE: These suggestions assume that the computer has not previously been set up for multiple displays.

Table 7-15 Issues, possible causes, and fixes (continued)

Items	Procedures
	<p data-bbox="619 260 831 285"><i>Troubleshooting steps</i></p> <p data-bbox="619 310 735 336">Quick check</p> <ol data-bbox="619 361 1437 730" style="list-style-type: none"><li data-bbox="619 361 1011 386">1. Verify that system light activity is OK.<li data-bbox="619 411 1437 462">2. Remove all external devices, including docking station. Recently added hardware or applications might cause graphics driver conflict and result in loss of video.<li data-bbox="619 487 1374 537">3. Perform hardware reset (8. Hard reset on page 75) and verify that HP Logo is presented correctly on display screen when pressing f10.<li data-bbox="619 562 1422 638">4. Test with external monitor via VGA port (or DisplayPort, HDMI, or other). Press power button and close the computer lid to force video output to external video. If unsuccessful, contact HP service.<li data-bbox="619 663 1437 730">5. If external video is OK, update BIOS, software, and drivers (4. Update BIOS and drivers on page 69), and perform soft reset (9. Soft reset (Default Settings) on page 76) if needed. Go to next step to verify display.
	<p data-bbox="619 758 746 783">Verify display</p> <ul data-bbox="619 808 1414 959" style="list-style-type: none"><li data-bbox="619 808 1414 879">• When booting to Windows, determine whether image appears on display screen (via Windows Screen Solutions or Windows logo  + p for display switcher).<li data-bbox="619 909 1366 959">• If there is video on the display, disconnect external display device, open the computer lid, and restart.
	<p data-bbox="619 984 1206 1010">The following steps are for authorized providers or technicians.</p> <ol data-bbox="619 1035 1422 1551" style="list-style-type: none"><li data-bbox="619 1035 1134 1060">1. Reseat display cable connection on system board.<li data-bbox="619 1085 1174 1110">2. Reseat display cable connection on display panel side.<li data-bbox="619 1136 1342 1161">3. Examine and reseat major components, such as hard drive and memory.<li data-bbox="619 1186 1422 1257">4. Test with minimum configuration (11. Test with minimum configuration on page 77) by removing hard drive to isolate operating system issues and testing video in F10 Setup.<li data-bbox="619 1283 1139 1308">5. If video is present, restart and retest the computer.<li data-bbox="619 1333 1230 1358">6. If video is present but bad, go to Display on page 101 section.<li data-bbox="619 1383 1139 1409">7. If issue persists (no video), test with external video.<li data-bbox="619 1434 1273 1459">8. If issue persists, test or replace with a confirmed working display.<li data-bbox="619 1484 1114 1509">9. If issue persists, replace discrete graphics card.<li data-bbox="619 1535 1369 1560">10. If issue persists, replace system board because of defective video function.
<p data-bbox="252 1572 293 1598">Tips</p>	<p data-bbox="619 1572 1437 1623">Swipe a metal piece (screwdriver) over wireless or mute buttons to act as if closing lid to force video output to external display device.</p>

Blinking lights

Use this information to interpret blinking lights on the computer.

Table 7-16 Issues, possible causes, and fixes

Items	Procedures
<i>Symptoms</i>	<i>Possible causes</i>
Lights blink on keyboard caps lock/num lock keys	Blinking lights on startup usually indicate a problem with basic functionality of a critical component (processor, BIOS, graphics cards, memory, and so on) because of a loose connection, defective parts, or recently added parts.
	<i>Troubleshooting steps</i>
	<ol style="list-style-type: none"> 1. Check for any blink patterns. Count the number of blinks in a sequence, followed by a pause for a few seconds. 2. See status, blinking lights, and error message (7. Status lights, blinking light codes, troubleshooting lights, and POST error messages on page 72) for corrective actions. 3. If internal hardware components (such as memory, hard drive) have been recently added, a component might not be connected properly. Remove and reseal new components (10. Reseat cables and connections on page 76) one at a time.
Note	Because the display might not be functional, lights are used to indicate an error.

Diagnostic error messages

Use the information in the table to help you understand diagnostic error messages.

Table 7-17 Issues, possible causes, and fixes

Items	Procedures
<i>Symptoms</i>	<i>Possible causes</i>
<ul style="list-style-type: none"> • Computer has power • POST error message displays (Windows logo has not yet appeared) 	Diagnostic error messages indicate a problem. There might be a problem with the instruction being sent from the BIOS to a hardware component (for example, keyboard failures), or incompatible hardware. Can usually be resolved by installing updated firmware for the component.
	<i>Troubleshooting steps</i>
	<ol style="list-style-type: none"> 1. See 7. Status lights, blinking light codes, troubleshooting lights, and POST error messages on page 72 for corrective actions. An example of a POST error message might be "Boot Device Not Found." 2. If there is power, you might be able to access BIOS. Reset BIOS to its default condition. (9. Soft reset (Default Settings) on page 76) 3. Restore hardware to its original condition (for example, bootable SSD instead of hard drive). 4. Reseat suspected components and verify connection. 5. Test suspected components using HP PC Hardware Diagnostics (UEFI) tool.
Note	An Error Message means that the system has finished BIOS hardware validation and is ready to launch the Startup Menu . To access the Startup Menu for further options, press the esc key while restarting the computer.

BIOS password

Use the information in the table to troubleshoot BIOS password issues.

Table 7-18 Issues, possible causes, and fixes

Items	Procedures
<i>Symptoms</i>	<i>Possible causes</i>
Some sections are unavailable (grayed out)	You must use an administrator password.
	<i>Troubleshooting steps</i>
	<ol style="list-style-type: none">1. Review F10 BIOS Setup Overview to determine which features must be enabled.2. Your BIOS settings might be managed by a BIOS administrator password setup.3. If you lost or forgot the user password, contact your IT personnel.
Reference	HP F10 Setup Overview
	See the HP PC BIOS F10 Setup Guide at http://support.hp.com .

Performance (OS)

Most software problems occur as a result of certain situations.

- The application was not installed or configured correctly.
- There is insufficient memory available to run the application.
- There is a conflict between applications.

Be sure that all the necessary device drivers are installed.

If an operating system other than the factory operating system is installed, check whether the operating system is supported and the application is certified for the version of the operating system.

Intermittent shutdown

Use this information to troubleshoot shutdown issues.

Table 7-19 Issues, possible causes, and fixes

Items	Procedures
<i>Symptoms</i>	<i>Possible causes</i>
<ul style="list-style-type: none">• Shutdown during startup• Shutdown during operation	It is often difficult to troubleshoot an intermittent issue. Possible causes include: Power-related issue: defective or insufficient power sources, poor connection. OS Custom Setting: Energy Saver (Power Management). Thermal-related issue: thermal sensors reach limits. Hardware related issue, voltage, out-of-range current, electrical short.
	<i>Troubleshooting steps</i>
	<ol style="list-style-type: none">1. Update BIOS and drivers. (4. Update BIOS and drivers on page 69)2. Perform hard reset (8. Hard reset on page 75)3. Perform soft reset (9. Soft reset (Default Settings) on page 76)

Table 7-19 Issues, possible causes, and fixes (continued)

Items	Procedures
	<p>Power-related issue</p> <ol style="list-style-type: none">1. Verify functionality of AC adapter alone. If it does not work, test with a verified working adapter.2. Verify battery alone. Verify that battery is not depleted. Test battery using HP PC Hardware Diagnostics (UEFI) tool.3. Verify connection of power button and cable.
	<p>OS custom settings</p> <ol style="list-style-type: none">1. Advise users to reset power options and close all applications that are not in use, including applications in the background.2. Test with a confirmed working operating system to isolate custom settings by users or any conflicting applications that cause shutdown.
	<p>The following steps are for authorized providers or technicians.</p>
	<p>Thermal-related issue</p> <ol style="list-style-type: none">1. Verify thermal condition:<ol style="list-style-type: none">a. Test fan using HP PC Hardware Diagnostics (UEFI) tool.b. Check fan and connection. Reseat fan cable.c. Be sure that no obstructions or dust are in heat sink fan, fin, or vent.d. Test with a verified working fan.e. Remove old thermal compound and pads and replace with new compound and pads.2. Verify thermal solution:<p>Use Thermal Monitor tool (available only to authorized service providers/ technicians) to perform stress test (processor and GPU), and verify that thermal sensors are within limits after thermal condition is serviced.</p>
	<p>Hardware-related issue</p> <ol style="list-style-type: none">1. Check for any signs of loose connections, bent pins, stray wires, dust, nearly faulty parts (bulging/leaking capacitor).2. Verify that lights are solid.3. If shutdown is reproducible, test essential hardware configuration:<ol style="list-style-type: none">a. If no issue with hardware configuration, reinstall one nonessential component at a time to determine faulty hardware.b. If issue persists, replace essential hardware with a confirmed working part, one at a time. If the computer does not boot, replace system board.
<p>Tips</p>	<p>Intermittent issues are difficult to reproduce and troubleshoot. It is important to record details about shutdown frequencies, system configuration (3D video application), and operating conditions.</p>

Blue screen

Use this information to troubleshoot blue screen issues.

Table 7-20 Issues, possible causes, and fixes

Items	Procedures
<p><i>Symptoms</i></p> <ul style="list-style-type: none">• Has power, light activity, fan spinning• HP Logo displays briefly• Fails to boot into Windows operating system, displays blue screen, and then crashes, restarts, or stops responding	<p><i>Possible causes</i></p> <p>Recent changes: conflict of instructions from multiple programs or just added hardware.</p> <p>Incompatible hardware and driver.</p> <p>Poor connection (hard drive, memory).</p> <p>Hardware malfunctioning due to overheating (GPU, processor).</p> <p>Defective hardware (memory, hard drive).</p>
<p>Important Notes & Resources</p>	<p><i>Troubleshooting steps</i></p> <p>There are many different ways to troubleshoot a blue screen error. Therefore, you need to identify working configuration and specific symptoms of the failure to narrow down the issue. See Blue screen (BSOD) error on page 119.</p>
	<p>Recommended resources</p> <p>Microsoft knowledge base:</p> <p>http://windows.microsoft.com/en-us/windows-8/resolve-windows-blue-screen-errors</p> <p>For more information, search for HP Troubleshooting Error Messages on a blue screen at http://www.hp.com.</p>

Overview of general troubleshooting steps for a blue screen error

1. Note the blue screen error message and what activity was performed at the time.
2. Perform a hard reset ([8. Hard reset on page 75](#)) after disconnecting all external peripherals.
3. Reset BIOS to default ([9. Soft reset \(Default Settings\) on page 76](#)) to prevent booting to another device.
4. Run HP Hardware Diagnostics to isolate major faulty hardware issues.
 - HP PC Hardware Diagnostics (UEFI) tool to test hard drive, memory, and system.
 - Thermal Monitor (available only to authorized service providers and technicians) tool to monitor temperature limits of processor and GPU.
5. Remove or undo recently added hardware ([5. Remove or uninstall recently added hardware, software on page 69](#)). For example, incompatible memory or new SSD storage.
6. Reseat cables and connections ([10. Reseat cables and connections on page 76](#)). Pay attention to proper installation of memory and hard drive.
7. Verify that a minimum of at least 100 MB of free space is available on your Windows partition.
8. If you can start Windows:

- a. Update BIOS and drivers ([4. Update BIOS and drivers on page 69](#)) to support updates for incompatibilities.
 - b. Get all the latest updates, using Windows Update.
 - c. Undo recent changes:
 - Startup using Last Known Good Configuration.
 - Use System Restore.
 - Roll back device driver in Device Manager.
 - d. Check for specific Error Message. See [Common blue screen error messages on page 128](#).
 - e. Start in safe mode ([11. Test with minimum configuration on page 77](#)) to troubleshoot issues.
9. If you cannot start Windows:
- a. Start in safe mode. ([11. Test with minimum configuration on page 77](#))
 - b. Use Startup Repair to fix Windows startup files.
 - c. Undo recent changes using System Restore to revert to a previous working state.
 - d. Check for specific STOP error by analyzing Crash Dump (retrieved via a bootable USB). See [Use Windows Debugging Tool on page 129](#).
 - e. Restore computer using System Recovery or image backup to factory settings.
10. Test with essential hardware configuration ([11. Test with minimum configuration on page 77](#)) with a verified working operating system (for instance, USB Windows-To-Go), if available, to isolate the software issue.

Freeze at Windows Logo (hang or lockup)

Use the following information to troubleshoot hang or lockup issues.

Table 7-21 Issues, possible causes, and fixes

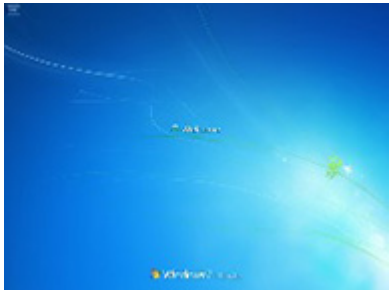
Items	Procedures
<p data-bbox="240 254 667 285"><i>Symptoms</i></p> <ul data-bbox="240 306 667 535" style="list-style-type: none"><li data-bbox="240 306 667 338">• Has power, light activity, fan spinning<li data-bbox="240 359 667 390">• HP Logo displays briefly<li data-bbox="240 411 667 464">• Attempt to start to operating system and freeze/hang at Windows logo<li data-bbox="240 485 667 535">• No response to pressing num lock or caps lock key 	<p data-bbox="671 254 1444 285"><i>Possible causes</i></p> <p data-bbox="671 306 1444 390">Conflict of instructions from multiple programs or drivers; installing a new hardware or program that is not compatible (might also cause a blue screen error—see blue screen issue).</p> <p data-bbox="671 877 1444 909"><i>Troubleshooting steps</i></p> <p data-bbox="671 930 1444 961">Perform the following steps to verify normal boot process:</p> <ol data-bbox="671 982 1444 1654" style="list-style-type: none"><li data-bbox="671 982 1444 1035">1. Disconnect all external peripherals, and perform a hard reset (8. Hard reset on page 75).<li data-bbox="671 1056 1444 1087">2. Perform soft reset (9. Soft reset (Default Settings) on page 76).<li data-bbox="671 1108 1444 1234">3. Update BIOS and drivers (4. Update BIOS and drivers on page 69).<ol data-bbox="746 1150 1444 1234" style="list-style-type: none"><li data-bbox="746 1150 1444 1182">a. Rollback to previous version might be necessary.<li data-bbox="746 1203 1444 1234">b. Go to safe mode to install drivers.<li data-bbox="671 1255 1444 1287">4. Run Hardware Diagnostics to isolate hardware issue.<li data-bbox="671 1308 1444 1360">5. Undo recent changes in Windows (5. Remove or uninstall recently added hardware, software on page 69).<li data-bbox="671 1381 1444 1434">6. Reseat cables and connections (10. Reseat cables and connections on page 76).<li data-bbox="671 1455 1444 1507">7. Start Windows in safe mode (11. Test with minimum configuration on page 77).<li data-bbox="671 1528 1444 1560">8. Use Startup Repair Windows to fix Windows damaged files.<li data-bbox="671 1581 1444 1654">9. Test with essential hardware configuration (11. Test with minimum configuration on page 77) with a verified working operating system (for instance, USB Windows-To-Go), if available, to isolate the software issue.

Electromagnetic Interference (EMI)

Use this information to troubleshoot EMI issues.

Table 7-22 Issues, possible causes, and fixes

Items	Procedures
<i>Symptoms</i>	<i>Possible causes</i>
System locks up, freezes in certain physical area or location	Electromagnetic interference (EMI).
	<i>Troubleshooting steps</i>
	<ol style="list-style-type: none">1. See (2. Examine the environment on page 68). Pay attention to external power source, high-frequency signals such as cell phones, microwave ovens.2. Move the computer to different locations nearby to determine where it fails and where it does not fail.3. Test with a verified working computer in original factory configuration.4. Consult with support.

No wake up

Use this information to troubleshoot wake-up issues.

Table 7-23 Issues, possible causes, and fixes

Items	Procedures
<i>Symptoms</i>	<i>Possible causes</i>
When resuming from a power management state the computer might display:	Power-saving mode; multiple-display setting.
<ul style="list-style-type: none">• Blank screen• Some light activity	

Table 7-23 Issues, possible causes, and fixes (continued)

Items	Procedures
	<i>Troubleshooting steps</i>
	<ol style="list-style-type: none">1. Verify that front power light (7. Status lights, blinking light codes, troubleshooting lights, and POST error messages on page 72) is blinking (indicating Sleep state). Press power button to exit Sleep.2. Reset BIOS to default (associated with OS Power Management in Power Menu) (4. Update BIOS and drivers on page 69)3. Check power management settings in Windows Power Options. Disable Sleep options if the issue is resolved.

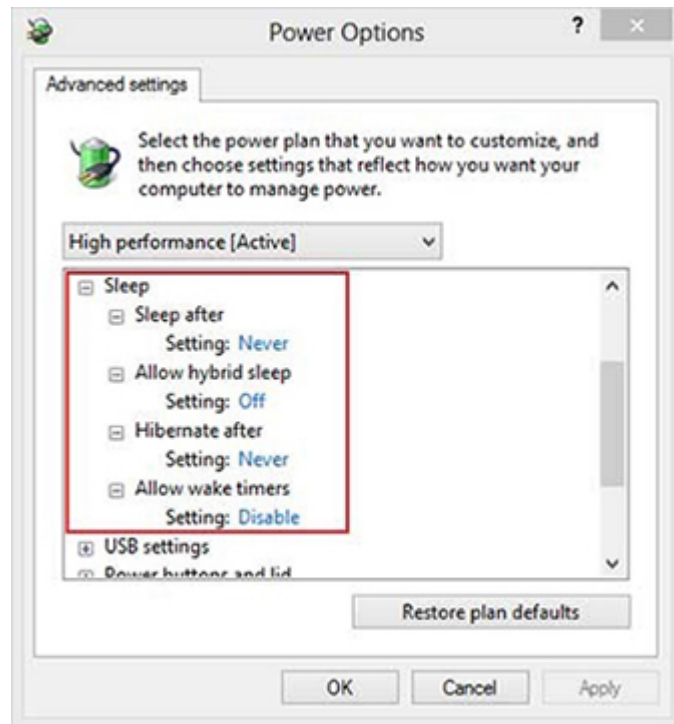

4. Screen saver is set. Press any key or touch touchpad to resume.
5. Verify that Display Choice is set to external video only. Toggle screen control key combination **fn + f4** or **Windows logo +P**.

Tips

If you are using a docking station, set your notebook display as a primary display. When the computer is undocked, you might think it is in a power-saving state, but the screen image could actually appear on an external display device in the docking configuration.

Unresponsive

Use this information to troubleshoot issues with responsiveness.

Table 7-24 Issues, possible causes, and fixes

Items	Procedures
<i>Symptom</i>	<i>Possible causes</i>
Unresponsive	Program in use has stopped responding to commands.
	<i>Troubleshooting steps</i>
	<ol style="list-style-type: none">1. If possible, use the Windows Task Manager to isolate and terminate the offending process.2. Attempt the normal Windows shutdown procedure.3. Restart the computer using the power button.

Slow performance

Use this information to troubleshoot performance issues.

Table 7-25 Issues, possible causes, and fixes

Items	Procedures
<i>Symptom</i>	<i>Possible causes</i>
Slow performance when performing small tasks, or even in idle mode	Processor is hot or hard drive is full.
	<i>Troubleshooting steps</i>
	Processor is hot
	<ol style="list-style-type: none">1. Verify that airflow to the computer is not blocked.2. Verify that chassis fans are connected and working properly. Some fans operate only when needed.3. Verify that the processor heat sink is installed properly.
	Hard drive is full
	<ol style="list-style-type: none">1. Transfer data from the hard drive to create more space on the hard drive. Microsoft recommends at least 200 MB to sync system files.2. Perform disk defragmentation to consolidate fragmented data on the hard drive so it works more efficiently.
Tips	See Routine maintenance for performance improvement on page 127 . See http://windows.microsoft.com/en-us/windows-8/free-up-disk-space . See http://windows.microsoft.com/en-us/windows/optimize-windows-better-performance#optimize-windows-better-performance=windows-vista .

HP Smart Adapter warning message

Use this information to troubleshoot power adapter warning messages.

Table 7-26 Issues, possible causes, and fixes

Items	Procedures
<p><i>Symptom</i></p> <p>Warning message appears in window</p> 	<p><i>Possible causes</i></p> <p>Less powerful AC adapter, BIOS out of date.</p>
	<p><i>Troubleshooting steps</i></p> <ol style="list-style-type: none"> 1. Update BIOS, which might contain information that assigns an appropriate adapter for the configuration. 2. Update the latest HP Hotkey Support software from Drivers website. 3. Be sure that the power source is sufficient (where adapter is connected). 4. Use appropriate AC adapter (often supplied with system) for optimum system performance. 5. Test with a verified working AC adapter. 6. Test the adapter on a verified working computer. 7. Contact HP for configuration details.
<p>Note</p>	<p>HP Smart AC adapter warning message: informs you that as power demands increase, the notebook might not perform at full capacity, which might result in longer battery-charging time. In cases of extreme power demands, the system might also throttle back the processor, or with systems that have a discrete video subsystem, a video balance mode might occur to further balance the power needs of the system.</p> <p>Because system processor functions always have priority over battery charging, charging delays occur first.</p>

Incorrect time and date

Use the following information to troubleshoot time and date issues.

Table 7-27 Issues, possible causes, and fixes

Item	Procedure
<p><i>Symptom</i></p> <p>Incorrect date and time</p>	<p><i>Possible cause</i></p> <p>Real-time clock (RTC) battery might need replacement.</p>
	<p><i>Troubleshooting steps</i></p> <ol style="list-style-type: none"> 1. Reset the date and time in the operating system Control Panel. 2. Replace the RTC battery. 3. Verify that date and time are correct.

Display

Use these sections to troubleshoot display issues.

Display anomalies



The display panel is a field-replaceable unit (FRU) and must be replaced by only authorized technicians. However, HP highly recommends that users and technicians observe symptoms and use the HP PC Hardware Diagnostics (UEFI) tool before any replacement.

Symptom

This section includes common display issues with symptoms.

- Blank or black video
 - Incorrect color, missing color, distorted image
 - Flickering image
 - Vertical lines (because of LDVS, decreased signal integrity, and data loss)
 - Dead pixel (because of display liquid, internal transistor, and others)
 - Horizontal lines (because of video memory)
 - Distorted when hot (because of thermal issue)
 - Cracked screen/image (physical damage)
 - Light leakage/bleeding
- Contact support for assistance.
- Humming noise (due to frequency settings)
- Contact support for assistance.

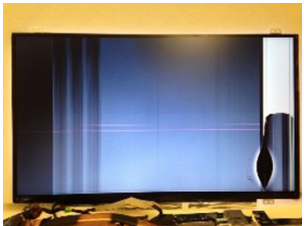
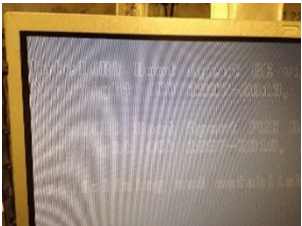
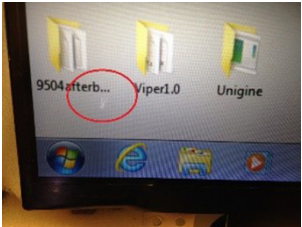
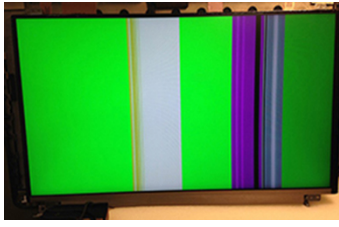
Table 7-28 Display anomaly illustrations

Display anomalies		
		
Cracked screen	Cracked image	Blurred image
		
Dead pixel	Vertical lines	Horizontal lines

Quick check

Use these steps to check the display.

- Visually examine the display for cracked screen, liquid crystal leak, dirty spots on glass, and other issues.
- Reset and update BIOS and docking firmware.
- Update operating system (OS), graphics or video drivers (Intel, AMD, NVIDIA, and others).

For custom images, HP highly recommends upgrading or installing Windows in UEFI mode or Legacy disabled to fully support hybrid graphics and avoid unexpected behaviors, for example, blue screen error, graphics or video issues, in the BIOS Legacy setting.

- Configure Windows settings (Power options, Screen brightness, Personalization, Screen resolution, and so on).
- Test with a verified working external display.
- Boot to Windows in safe mode.
- Test with a verified working operating system (for instance, shipping image).

HP PC Hardware Diagnostics (UEFI) for video test

Use this tool to quickly determine if the display issue is related to a real hardware issue.

To start HP PC Hardware Diagnostics (UEFI), when the computer is starting up, press the **f2** key, select **Component Tests**, and then select **Video**.

There are three options:

- **Video Memory Check:** to test video memory
- **Palette Check:** to test the three video color components (red, green, blue)
- **Dead Pixel Check:** to check dead pixels in eight different colors (Dead Pixel Check is available with the HP PC Diagnostics 3-in-1 USB Key tool)

Review the video troubleshooting in the following Display section for specific issues and possible solutions. For additional information about display problems, see documentation provided by the product manufacturer.

Display assembly diagram

The display assembly diagram shows basic video components: system board, graphics cards, display cables, display connectors, operating system (OS), graphics driver, and LCD display panel. Any component or a combination of these components can contribute to a video issue.

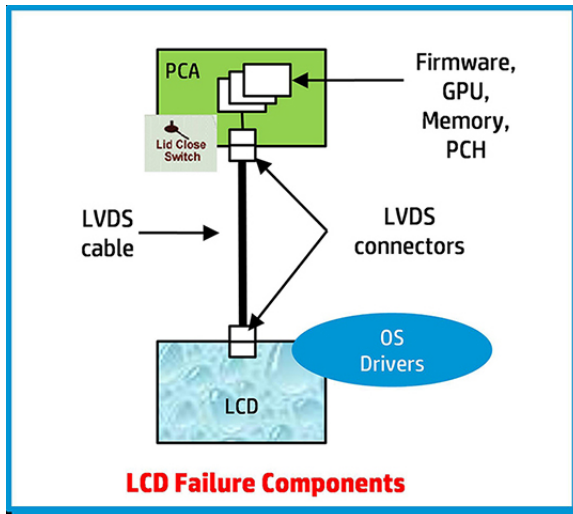

NOTE: The lid close switch is a Hall-effect sensor located in the top cover. When the display is closed, the sensor acts like a switch is closed. A notebook can force a video output to an external monitor, or go to hibernation or standby mode through power management. If the display screen does not light up when the display is open, the lid close switch (Hall-effect sensor) could be faulty.

Dead pixel

Display panel might show one or more pixels that are not properly lit when displaying a single color over the screen area. Use HP PC Hardware Diagnostics (UEFI) tool to determine those defective pixels.

There is no solution for dead pixels. See [Display issue: pixel anomalies on page 133](#) for the HP dead pixel policy.

No video (internal)

Use this information to troubleshoot video issues.

Table 7-29 Issues, possible causes, and fixes

Items	Procedures
<i>Symptoms</i>	<i>Possible causes</i>
No internal video with certain programs (for example, video-intensive games)	Display resolution, brightness, faulty lid switch, running a program requiring a higher resolution than the display screen can support. Faulty lid switch might put the system into Sleep or Hibernation mode.
	<i>Troubleshooting steps</i>
	Use an external monitor with higher resolution. Test with external monitor using HDMI or HP port. Press the power button and close the computer lid to force video output to external video. If there is still no video, contact support.
References	See section No video (with power) on page 89 for display information.

No video (external)

Use this information to troubleshoot external video issues.

Table 7-30 Issues, possible causes, and fixes

Items	Procedures
<i>Symptom</i>	<i>Possible causes</i>
No image on external monitor	External monitor, resolution, display configuration, drivers.
	<i>Troubleshooting steps</i>
	<ol style="list-style-type: none">1. Be sure external monitor is compatible with the computer.2. Be sure that external monitor is turned on.3. Press any key to exit the power-saving mode.4. Adjust the brightness of the monitor.5. Test with a verified working monitor.6. Test the monitor via internal ports (VGA, DP ports).7. Install latest video driver.8. Reset the screen resolution as described in the documentation.9. Configure display choice, and then force output to external video by closing the notebook lid or pressing fn + f4 to switch screen output.

DisplayPort/VGA

Use this information to troubleshoot DisplayPort and VGA issues.

See [No video \(external\) on page 103](#).

HDMI

Use this information to troubleshoot HDMI issues.

Table 7-31 Issues, possible causes, and fixes

Items	Procedures
<i>Symptoms</i>	<i>Possible causes</i>
<ul style="list-style-type: none">• Display issue• Sound issue	Cable, connection, settings.
	<i>Troubleshooting steps</i>
	Quick Check
	<ol style="list-style-type: none">1. Verify that the HDMI device input source is set correctly (for example, HDMI1).2. Be sure you are using the correct HDMI cable.3. Check connection and reconnect the HDMI cable.4. Verify whether sound output is configured correctly in Control Panel > Sound Manager.
	<ol style="list-style-type: none">1. Perform hard reset (4. Update BIOS and drivers on page 69).2. Update BIOS and drivers (4. Update BIOS and drivers on page 69) when you hear sound but do not see video on HDTV.

No or bad external video via docking

Use this information to troubleshoot video issues while docking.

Table 7-32 Issues, possible causes, and fixes

Items	Procedures
<i>Symptoms</i>	<i>Possible causes</i>
No or bad image on external monitor via ports of docking station (such as VGA, DP, TB, display port, and others)	Rooted from system board, software or drivers, dock connectors, docking station hardware or firmware, dock video ports (DP, VGA, and others).
	<i>Troubleshooting steps</i>
	<ol style="list-style-type: none">1. Be sure that external monitor is turned on.2. Be sure that external monitor is compatible with the computer.3. If applicable, plug the dock in different Type-C ports. For more information, see the technical white paper titled "HP Elite Dock with Thunderbolt 3 & HP ZBook Dock with Thunderbolt 3." Go to http://www.hp.com/ and search for HP ZBook Thunderbolt 3 Dock User Guide.4. If the screen image is distorted, try a DP-to-VGA adapter. Connect the adapter to each DisplayPort and VGA port of the dock.5. Test the monitor via internal ports (such as VGA, DP, HDMI, and others).6. Verify that dock connectors of the notebook and the dock are clean, without dust, debris (for example, using air duster).7. Ideally, use a verified working operating system or system connected to the dock to isolate the issue of the current operating system.8. Ideally, use a verified working docking station to isolate the faulty dock.9. Update to latest dock firmware. Follow the installation instructions carefully. You may want to try a DP-to-VGA adapter if you have a distorted screen image. Connect the adapter to each DisplayPort of the dock. If you still cannot update the dock, attempt to update it on a confirmed working notebook before having the dock replaced.
Note	See the technical white paper titled "Multiple displays on HP ZBook Mobile Workstations" from HP platform support website. Go to http://h20195.www2.hp.com/v2/getpdf.aspx/4aa5-2657enw .

Incorrect or missing color/distorted image

Use this information to troubleshoot image issues.

Table 7-33 Issues, possible causes, and fixes

Items	Procedures
<i>Symptoms</i>	<i>Possible causes</i>
System works normally but the display shows: <ul style="list-style-type: none">• Missing or strange color• Image distortion	Loose connection, display cable, display, graphics card.

Table 7-33 Issues, possible causes, and fixes (continued)

Items	Procedures
	<i>Troubleshooting steps</i>
	Verify with external monitor
	<ol style="list-style-type: none">1. Use combination fn + f4 to enable output to external monitor.2. Close the lid.
	If the external monitor also shows incorrect color, it is a graphics card issue. Test with a verified working graphics card.
	Verify monitor cable and cable connection (monitor disassembly required).
	Be sure the monitor cables are not pinched or damaged.
	Be sure the monitor cables have good connection at both ends (system board and display panel).
	<ul style="list-style-type: none">• If moving cables affects the image, the monitor cable is the cause of the issue. Test with a confirmed working cable.• If moving cables does not affect the image, the monitor has an issue. Test with a confirmed working monitor.

Touch screen

Use this information to troubleshoot touch screen issues.

Table 7-34 Issues, possible causes, and fixes

Items	Procedures
<i>Symptoms</i>	<i>Possible causes</i>
Unresponsive	Dirt and smudge, driver, touch display configuration, power management.
Inaccurate	
	<i>Troubleshooting steps</i>
	Quick check
	Turn off the computer, spray glass cleaner onto a soft, damp cloth, and gently wipe the screen to remove dirt and smudge.
	NOTE: Do not spray cleaner directly onto the screen.

Table 7-34 Issues, possible causes, and fixes (continued)

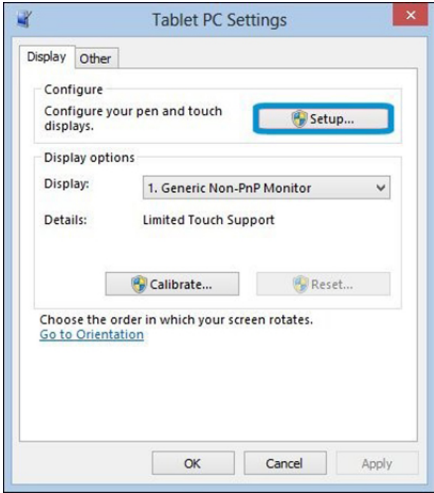
Items	Procedures
<p>Configure the touch display in Control Panel > Tablet PC Settings</p> 	<ol style="list-style-type: none"> 1. Restart the computer. 2. Verify touch screen and graphics drivers. 3. Configure the touch display to identify the screen as a touch screen, as shown in the image at left. 4. Calibrate the screen and reset if touch functionality is still not working correctly. 5. Perform diagnostic test in HP Hardware Diagnostics under Component Tests > Touch Screen. If the diagnostics tests pass but the touch screen still does not respond, continue following the steps. 6. Adjust the power management settings for your touch screen. If the touch screen stops working after waking from sleep, adjust the power management settings so that the touch screen device stays active while the computer is in Sleep mode. 7. Perform Microsoft System Restore, and restore to a time when the system was working. 8. Perform HP System Recovery if none of the previous actions resolve the issue.

I/O devices

Use this information to troubleshoot I/O device issues.

NOTE:

- Be sure that external devices are supported and compliant (for example, USB Type-C, Thunderbolt, PCI Express).
- If you have problems with external devices not provided by HP, contact device manufacturers for compatibility and latest drivers before troubleshooting (for example, USB devices, Thunderbolt devices, PCI express card reader, VGA, display, HDMI monitors, speakers).
- Be sure I/O devices are properly inserted into the I/O ports, and then be sure that Windows Device Manager recognizes the I/O devices.

Keyboard

Use this information to troubleshoot keyboard issues.

Table 7-35 Issues, possible causes, and fixes

Items	Procedures
<i>Symptoms</i>	<i>Possible causes</i>
Keystrokes not recognized	Dust trapped under keycap, loose keycap, loose keyboard connection, defective keyboard.
Characters not matched	

Table 7-35 Issues, possible causes, and fixes (continued)

Items	Procedures
	<i>Troubleshooting steps</i>
	<ol style="list-style-type: none"> 1. Inspect the keyboard for any signs of dust, liquid, or debris trapped under sticky keys that might prevent keystroke recognition. 2. Check for incomplete connection between keyboard and system board by verifying that caps lock or num lk light turns on when you press the key. 3. Verify whether the keyboard is recognized in Windows Device Manager, and verify whether the keyboard driver is installed properly. 4. Test with a working external keyboard (such as a USB keyboard). Also test in Windows for special keys (caps lock, shift, ctrl, fn, Windows, alt) if necessary. 5. Test with HP PC Hardware Diagnostics (UEFI) to isolate a hardware issue from a software issue. 6. Verify that BIOS is up to date. If so, resetting BIOS to default might help. 7. Test with a verified working operating system, or restore the operating system to be sure that the issue is not caused by items such as different language settings, sticky keys feature, and so on. 8. Verify that keyboard flex cables are fully inserted and in good condition.
	The following steps are for authorized providers and technicians.
	<ol style="list-style-type: none"> 1. Verify that keyboard flex cable is in good condition (no delamination or torn cable end, no missing or cracked tracks, pads). 2. Verify that keyboard flex cable ends are fully inserted and aligned with connectors on system board, and those connector tabs are properly closed. Reseat cables. 3. Replace new internal keyboard and retest.
Tips	If a key works only when pressed with force, inspect and remove debris trapped under keycap.

Keyboard pointing stick (select products only)

Use this information to troubleshoot pointing stick issues.

Table 7-36 Issues, possible causes, and fixes

Items	Procedures
<i>Symptom</i>	<i>Possible causes</i>
Point stick not working properly	Dust trapped under point stick, loose point stick cap.
	<i>Troubleshooting steps</i>
	<ol style="list-style-type: none"> 1. Inspect for any signs of dust or liquid spill that prevent point stick from working. 2. Check whether point stick cap is loose, and reseat it if necessary.
	The following steps are for authorized providers and technicians.

Table 7-36 Issues, possible causes, and fixes (continued)

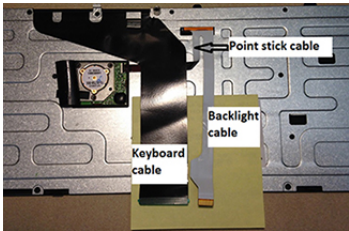
Items	Procedures
 <p>Example of back of keyboard, including keyboard, point stick, and backlight cables.</p>	<ol style="list-style-type: none"> 1. Verify whether keyboard flex cables are in good condition (no delamination or torn cable end, no missing or cracked tracks, pads). 2. Verify that keyboard flex cable ends are fully inserted and aligned with connectors on system board and back of keyboard, and that connector tabs are properly closed. 3. Reseat point stick cables.

Keyboard backlight

Use this information to troubleshoot keyboard backlight issues.

Table 7-37 Issues, possible causes, and fixes

Items	Procedures
<i>Symptom</i>	<i>Possible causes</i>
Backlight function not working properly	Backlight disabled, loose connection.
	<i>Troubleshooting steps</i>
	<p>NOTE: Not all notebook computers have backlit keyboards.</p> <p>A keyboard function key lets you turn the light on and off. Verify whether backlit feature is not disabled by pressing a combination of fn + backlit key.</p>
The following steps are for authorized providers or technicians.	
	<ol style="list-style-type: none"> 1. Verify whether backlight flex cables are in good condition (no delamination or torn cable end, no missing or cracked tracks or pads). 2. Verify that backlight flex cable ends are fully inserted and aligned with connectors on system board and that connector tabs are properly closed. 3. Reseat backlight cable.

Touchpad

Use this information to troubleshoot touchpad issues.

Table 7-38 Issues, possible causes, and fixes

Items	Procedures
<i>Symptoms</i>	<i>Possible causes</i>
Not working properly	Touchpad turned off, driver, settings.

Table 7-38 Issues, possible causes, and fixes (continued)

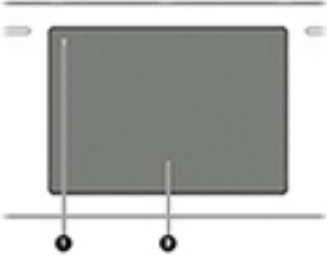
Items	Procedures
(1) Touchpad on/off button	<i>Troubleshooting steps</i>
(2) Touchpad	<ol style="list-style-type: none"> 1. Ensure touchpad on/off light is not amber (disabled). Double tap to enable. 2. Verify whether touchpad device is listed in Device Manager > Mice and other pointing devices. 3. Install the latest touchpad driver. 4. Adjust touchpad settings (Control Panel > Mouse). 5. Test touchpad controller using the HP PC Hardware Diagnostics (UEFI) tool (f2 > Component Tests > Mouse Test > Pointer Test & Drag and Drop Test).
	
<p>The following steps are for authorized service providers/technicians.</p> <ol style="list-style-type: none"> 1. Check the touchpad cable for damage or a loose connection, and then reseat the touchpad cable. 2. If issue persists, replace the touchpad and verify the change. 	

Network connectivity (RJ-45 jack)

Use this information to troubleshoot network issues.

Table 7-39 Issues, possible causes, and fixes

Items	Procedures
<i>Symptoms</i>	<i>Possible causes</i>
<ul style="list-style-type: none"> • Unable to find networks (yellow bang) • Connection dropouts • Slow performance 	Network source, cable, connection, RJ-45 (network) jack, driver, settings.
	<i>Troubleshooting steps</i>
	Quick Check: verify the network status lights that are supposed to flash when there is network activity.

Network connectivity wireless (WLAN)

Use this information to troubleshoot wireless connectivity issues.

Table 7-40 Issues, possible causes, and fixes

Items	Procedures
<i>Symptoms</i>	<i>Possible causes</i>
<ul style="list-style-type: none"> • Unable to find networks (yellow bang) • Connection dropouts • Slow performance 	Network source, cable, connection, wireless module, driver, settings.

Table 7-40 Issues, possible causes, and fixes (continued)

Items	Procedures
The following steps are for authorized providers or technicians.	
	<ol style="list-style-type: none"> 1. Verify that the wireless module and its antenna cables are fully inserted and in good condition (see WLAN module removal and replacement section). Reseat wireless module and antenna connection. 2. Verify the module antenna cable connection is not loose. 3. Verify that antenna cables are properly connected to the MAIN and AUX terminals (see WLAN module removal and replacement section).

WWAN

Use this information to troubleshoot WWAN issues.

Table 7-41 Issues, possible causes, and fixes

Items	Procedures
<i>Symptom</i>	<i>Possible causes</i>
Unable to find networks or service	Network source, cable, connection, driver, settings.
	<i>Troubleshooting steps</i>
	<ol style="list-style-type: none"> 1. Update to the latest driver and utility. 2. Check with network service provider for signal coverage. 3. Be sure signal strength is good. 4. Be sure that your service is active.

The following steps are for authorized providers or technicians.

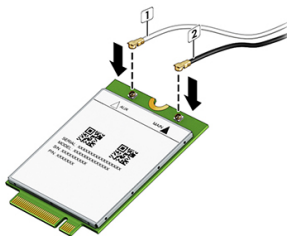

- Verify module and antenna cable connections are not loose.
- Verify antenna cables are properly connected to the correct terminals. For example, the antenna cable labeled 1 connects to the Main terminal labeled 1. The antenna cable labeled 2 connects to the Aux terminal labeled 2.

USB

Use this information to troubleshoot USB port issues.

Table 7-42 Issues, possible causes, and fixes

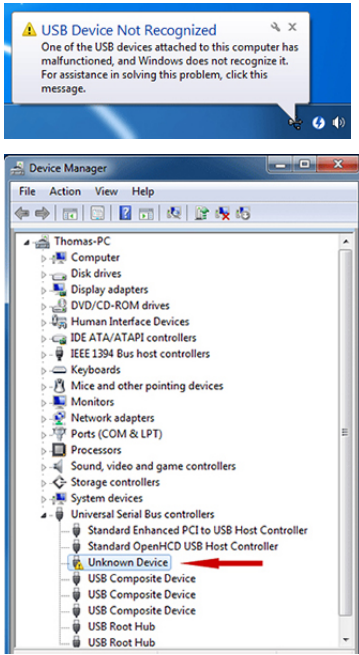
Items	Procedures
<p><i>Symptoms</i></p> <ul style="list-style-type: none"> • USB devices are not recognized • USB devices are not charging 	<p><i>Possible causes</i></p> <p>USB devices do not have the latest software drivers, port has insufficient power, or the devices are not compliant.</p> <p>NOTE: USB Type-C uses a different connector.</p>
<p>Examples of USB device Not Recognized</p>  <p>The image shows two screenshots. The top one is a Windows error dialog box titled 'USB Device Not Recognized' with a yellow warning icon. The text inside says: 'One of the USB devices attached to this computer has malfunctioned, and Windows does not recognize it. For assistance in solving this problem, click this message.' The bottom screenshot is the Windows Device Manager window. Under 'Universal Serial Bus controllers', there is an entry for 'Unknown Device' with a yellow warning icon, highlighted by a red arrow.</p>	<p><i>Troubleshooting steps</i></p> <ol style="list-style-type: none"> 1. Unplug the USB device. Restart the computer (wait for 2-5 minutes) to reset the USB port or hub in case of a power surge. 2. Perform a soft reset (9. Soft reset (Default Settings) on page 76), and verify if the USB device is recognized. 3. Verify whether the USB device is recognized in Device Manager > Universal Serial Bus Controller, or the USB is recognized without a yellow warning symbol, or bang. 4. Verify whether the latest USB driver, USB chipset driver, or both are installed. You can remove or reinstall the USB driver. 5. Be sure the USB device is supported, for example, USB 3.0 device requires more power draw (0.9 A) from a USB port than a USB 2.0 device (0.5 A). As a result, identify the USB charging port to be used for charging a USB device, or an external AC power adapter might be required for an external USB storage device to work properly. 6. Test with verified working USB devices (keyboard, mouse, USB key) to be sure USB ports are functional. 7. Test the USB device on a verified working computer to be sure the USB device is not malfunctioning.

Smart card reader

Use this information to troubleshoot smart card reader issues.

Table 7-43 Issues, possible causes, and fixes

Items	Procedures
<p><i>Symptoms</i></p> <ul style="list-style-type: none"> • Not recognized • Unable to write 	<p><i>Possible causes</i></p> <p>Physical damage, incorrect insertion, dirt, driver, malfunctioning card reader.</p> <p>NOTE: Some cards have a read-write security switch on the card. Be sure that switch is set to Write Enabled before attempting to write data to it.</p>

Table 7-43 Issues, possible causes, and fixes (continued)

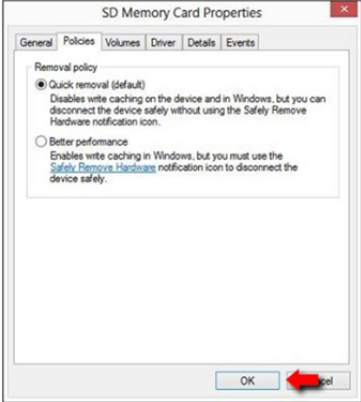
Items	Procedures
Card Reader Removal Policy	<i>Troubleshooting steps</i>
	<ol style="list-style-type: none"> 1. Verify card reader removal policy. 2. Be sure that the card has no physical damage. 3. Inspect the ends of the memory cards for dirt or material closing a hole or spoiling a metal contact. Clean the contacts with a lint-free cloth and small amounts of isopropyl alcohol. Replace the memory card if necessary. 4. Reinstall and update the drivers for the card reader. 5. Be sure that the smart card reader is compliant with ISO 7816 Class A, B, and C. 6. Reinsert the card reader with correct face as described in its documentation. 7. Check reader function with a verified working card.

IMPORTANT: If the card reader has an in-use indicator light, do not insert or remove memory cards while the light is flashing. Doing so might cause loss of data on the card or might permanently damage the card reader.

Speaker, headphone - audio issues

Use this information to troubleshoot audio issues.

Table 7-44 Issues, possible causes, and fixes

Items	Procedures
<i>Symptoms</i>	<i>Possible causes</i>
<ul style="list-style-type: none"> • No sound from external or internal speakers 	Volume turned down, sound card not recognized, malfunctioning hardware, electronic interference.
<ul style="list-style-type: none"> • Distorted sound, too soft, too loud, intermittent 	

Table 7-44 Issues, possible causes, and fixes (continued)

Items	Procedures
	<p data-bbox="619 258 831 289"><i>Troubleshooting steps</i></p> <ol data-bbox="619 310 1447 1039" style="list-style-type: none"> <li data-bbox="619 310 1398 342">1. Remove any device connected to the audio jack to enable the internal speaker. <li data-bbox="619 363 900 394">2. Close all open programs. <li data-bbox="619 415 1447 594">3. Perform one of these tasks: <ul data-bbox="667 468 1447 594" style="list-style-type: none"> <li data-bbox="667 468 1447 520">• Adjust volume by pressing fn + f6 or f7. Be sure that volume button light is not amber (mute). <li data-bbox="667 541 1447 594">• Adjust Windows volume control by selecting the speaker icon on the Windows taskbar. Be sure that the sound is not muted. <li data-bbox="619 615 1294 646">4. Verify that the sound card is detected in Windows Device Manager. <li data-bbox="619 667 963 699">5. Reinstall the latest audio driver. <li data-bbox="619 720 1337 772">6. Test audio device using the HP PC Hardware Diagnostics (UEFI) tool (f2 > Component Tests > Audio). <li data-bbox="619 793 1378 846">7. Test with a verified working operating system. If issue is resolved, restore full operating system. <li data-bbox="619 867 1187 898">8. Test with verified working external speakers or headset. <li data-bbox="619 919 1018 951">9. Reseat internal speaker connections. <li data-bbox="619 972 1075 1003">10. Test with verified working internal speakers. <li data-bbox="619 1024 916 1056">11. Replace internal speakers.
No sound from headphones	<ol data-bbox="619 1056 1447 1392" style="list-style-type: none"> <li data-bbox="619 1056 1447 1245">1. Perform one of these tasks: <ul data-bbox="667 1108 1447 1245" style="list-style-type: none"> <li data-bbox="667 1108 1447 1161">• Adjust volume by pressing fn + f6 or f7. Be sure that volume button light is not amber (mute). <li data-bbox="667 1182 1447 1245">• Adjust Windows volume control by selecting the speaker icon on the Windows taskbar. Be sure that the sound is not muted. <li data-bbox="619 1266 1011 1297">2. Check headphone cable connection. <li data-bbox="619 1318 1043 1350">3. Test with a verified working audio board. <li data-bbox="619 1371 1075 1392">4. Replace audio board and verify the change.
No sound from external speakers	<ol data-bbox="619 1413 1447 1759" style="list-style-type: none"> <li data-bbox="619 1413 1075 1444">1. Verify that external speakers are turned on. <li data-bbox="619 1465 1107 1497">2. Disconnect headphones from headphone jack. <li data-bbox="619 1518 1447 1686">3. Perform one of these tasks: <ul data-bbox="667 1570 1447 1686" style="list-style-type: none"> <li data-bbox="667 1570 1447 1623">• Adjust volume by pressing fn + f6 or f7. Be sure that volume button light is not amber (mute). <li data-bbox="667 1644 1447 1686">• Adjust Windows volume control by selecting the speaker icon on the Windows taskbar. Be sure that the sound is not muted. <li data-bbox="619 1707 1410 1759">4. Check for possible interference from devices nearby that might affect the audio (cell phone or portable communications handset).

Thunderbolt (TB)

Use this information to troubleshoot Thunderbolt issues.

Table 7-45 Issues, possible causes, and fixes

Items	Procedures
<i>Symptom</i>	<i>Possible causes</i>
Thunderbolt device not working	BIOS, drivers, and user settings.
	<i>Troubleshooting steps</i>
	<ol style="list-style-type: none">1. Update to the latest BIOS and choose appropriate TB Port settings.2. Reset User Account Settings to default.3. Update Intel Thunderbolt software that includes firmware version (for TB controller), driver version (operating system driver), and application version.

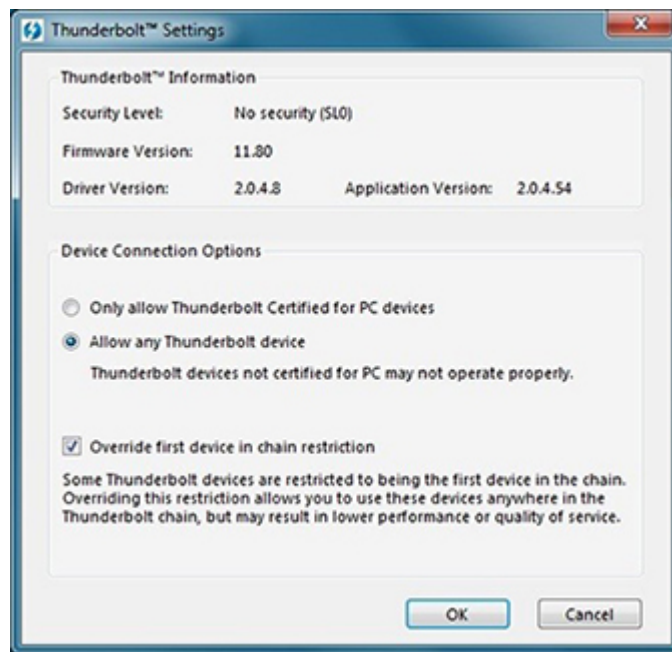

4. Verify that Windows Device Manager detects the TB device.
5. Verify cable connection to TB port.
6. Test with a verified working TB board, if possible.

NOTE: Thunderbolt is new technology. Thunderbolt cable and Thunderbolt device must be compatible with Windows. To determine whether your device is Thunderbolt Certified for Windows, see <https://thunderbolttechnology.net/products>.

Storage

Use this information to troubleshoot storage issues.

 **NOTE:**

- Back up all critical data before troubleshooting the drive.

- Before contacting support, HP recommends that you run a drive (HDD, SSD, M.2 drive) test using the HP PC Hardware Diagnostics (UEFI) tool on the suspected failed drive.
- Diagnose the hard drive using BIOS, Diagnostics built in the shipping image, or an external USB (<https://support.hp.com/us-en/help/hp-pc-hardware-diagnostics>).
- HP recommends the drive quick test to quickly (less than 10 minutes) identify the malfunctioning drive. If the issue still exists, run Extensive Test (more than two hours, or loop mode, which runs until an error occurs).
- If any test fails, record failure code and contact support for instructions about how to order a replacement hard drive.
- If all of the tests pass, the hard drive is not damaged. As a rule, HP will not replace a hard drive under warranty that does not fail the HP Hard Drive Self-Test.
- If there is no physical problem with the hard drive or memory, then try reinstalling the Windows operating system to troubleshoot the problem.

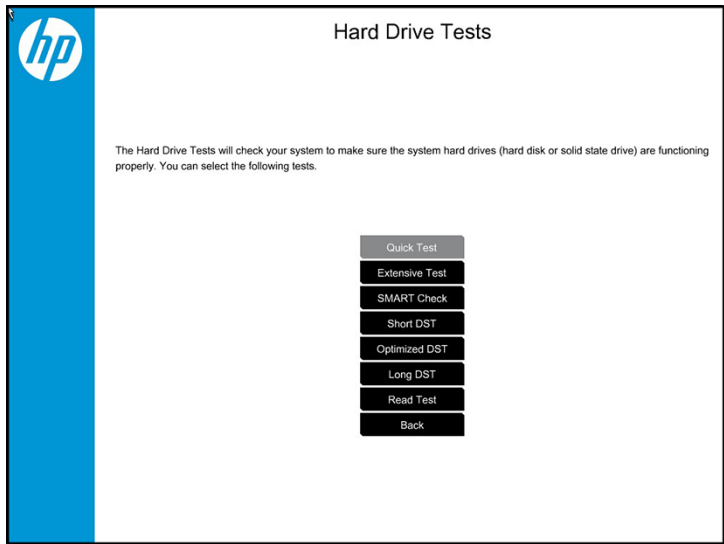

Hard drive or SSD not recognized

Use this information to troubleshoot storage device issues.

Table 7-46 Issues, possible causes, and fixes

Items	Procedures
<i>Symptom</i>	<i>Possible causes</i>
Hard drive is not recognized during POST	Loose connection, faulty hard drive, faulty drive configuration/BIOS setting.

Table 7-46 Issues, possible causes, and fixes (continued)

Items	Procedures
	<i>Troubleshooting steps</i>
	<ol style="list-style-type: none"> 1. Perform a hard reset (8. Hard reset on page 75). 2. Reset BIOS to default. 3. Verify hard drive connection and flex cable. Reseat hard drive and cable connection. For multiple storage devices, keep the primary drive with the operating system and remove other devices. 4. Use the HP Hardware Diagnostics tool to verify that the drive is recognized and test it. 5. If the hard drive fails diagnostics, record failure and have the drive replaced. 6. Identify when the issue is related to software. If the hard drive passes diagnostics, test the drive on a verified working computer. If the failure follows the drive, reinstall the operating system to be sure that software is not an issue. 7. Test with a verified working hard drive. If it is still not recognized, the system board is faulty.
	NOTE: If the drive is seen in BIOS and Diagnostics, try a secure erase before replacing a drive as this might resolve related issues.

No boot to operating system (no read-write error)

Use this information to troubleshoot issues with booting to the operating system.

Table 7-47 Issues, possible causes, and fixes

Items	Procedures
<i>Symptoms</i>	<i>Possible causes</i>
<ul style="list-style-type: none"> • POST error message: Boot Device not found (3F0) • Hang when booting to operating system 	Operating system, loose connection, faulty hard drive, BIOS configuration, Secure Boot.
	<i>Troubleshooting steps</i>
	<ol style="list-style-type: none"> 1. Verify whether Secure Boot is enabled in BIOS. Secure Boot prevents legacy boot devices from starting the computer, including bootable CDs and DVDs. 2. Reset BIOS to default. Be sure that BIOS Boot Mode in Boot Option is set up properly for bootable device and its operating system (for example, UEFI Native for an older Windows OS). Another example, choosing Legacy Boot Order for a UEFI device causes "Boot Device not found (3F0)" error. 3. Verify hard drive connection and flex cable. Reseat connection. For multiple storage devices, keep the primary drive with the operating system and remove other devices. 4. Use PC Hardware Diagnostics tool to test. Record failure code and have the hard drive replaced. 5. If there is no error, reinstall the operating system using HP Restore. 6. Test with a verified working operating system hard drive, if available.

Table 7-47 Issues, possible causes, and fixes (continued)

Items	Procedures
Note	If there is a hard drive POST error message, see POST error messages and user actions on page 126 .

Read-write error

Use this information to troubleshoot read and write errors.

Table 7-48 Issues, possible causes, and fixes

Items	Procedures
<i>Symptoms</i>	<i>Possible causes</i>
<ul style="list-style-type: none"> POST error message (for example, error code 301) Hang when working on data, files, documents 	Loose connection, faulty hardware. <i>Troubleshooting steps</i> <ol style="list-style-type: none"> Perform a hard reset (8. Hard reset on page 75). Reset BIOS to default (9. Soft reset (Default Settings) on page 76). Verify the drive connection and flex cable. Reseat connection (10. Reseat cables and connections on page 76). Use the HP Hardware Diagnostics tool to test. If failed, record failure code and have the hard drive replaced. If no error with HP PC Hardware Diagnostics (UEFI) tool, try to repair the hard drive and its files in Windows (using command “CHKDSK /f /r /x”). Use HP Restore to reinstall the operating system, if needed. Test with a verified working hard drive. If it is not recognized, the system board is faulty.
Note	If there is a hard drive POST error message, see POST error messages and user actions on page 126 .

Slow performance

Use this information to troubleshoot performance issues.

Table 7-49 Issues, possible causes, and fixes

Items	Procedures
<i>Symptoms</i>	<i>Possible causes</i>
Slow performance even when performing small read-write operations	Operating system files, hard drive is full.
	<i>Troubleshooting steps</i>
	<ol style="list-style-type: none"> Transfer data from the hard drive to create more space. Microsoft recommends at least 200 MB to sync system files. Perform disk defragmentation to consolidate fragmented data on the hard drive so that it works more efficiently. <p>NOTE: Do not defragment an SSD.</p>

Table 7-49 Issues, possible causes, and fixes (continued)

Items	Procedures
Tips & tricks	For optimal system performance, place your operating system and all of your most commonly used applications and files on the fastest hard drive (SSD) and fastest areas on the drive (primary partition of 200 GB max). See Routine maintenance for performance improvement on page 127 .

Blue screen (BSOD) error

A faulty hard drive can cause a blue screen error. Perform the drive tests using the HP Diagnostics Tool to be sure that the drive is functional.

If all of the tests are successful, see [Common blue screen error messages on page 128](#) for detailed troubleshooting steps.

Noisy hard drive

Use this information to troubleshoot a noisy hard drive.

 **IMPORTANT:** Because an SSD has no moving parts, it does not make loud or clicking noises.

Depending on type and rotational speed, some hard drives make more noise than others.

Not all noises are related to the fan or hard drive.

Table 7-50 Issues, possible causes, and fixes

Items	Procedures
<i>Symptoms</i>	<i>Possible causes</i>
<ul style="list-style-type: none">• Loud noise from hard drive• Clicking noise from hard drive• Still boots to operating system and operates normally	BIOS, hard drive firmware, driver, faulty drive, power supply (AC adapter).
	<i>Troubleshooting steps</i>
	<ol style="list-style-type: none">1. Update BIOS and hard drive firmware.2. Examine AC adapter to be sure that it is not faulty or overloaded. Disconnect all peripherals (USB storages, dock, and others).3. Remove hard drive to isolate the noise.4. Test the hard drive on a verified working computer if the noise continues. If the hard drive makes the same noise or clicking sounds, the sounds are either normal sounds for the hard drive or a fault with the hard drive.5. Verify original hard drive connection and flex cable. Reseat hard drive and connection.6. Run HP PC Hardware Diagnostics (UEFI). If failed, record failure code and replace hard drive.7. If you find no error with HP PC Hardware Diagnostics (UEFI), perform disk defragmentation. Some hard drives make a clicking noise when highly fragmented.

Table 7-50 Issues, possible causes, and fixes (continued)

Items	Procedures
Tips	For optimal system performance, place your operating system and all of your most commonly used applications and files on the fastest hard drive or SSD and on the fastest areas on the drive (primary partition of 200 GB max). See Routine maintenance for performance improvement on page 127 .

Mechanical

Use this information to troubleshoot mechanical issues.

Noise (sound)

Use this information to troubleshoot abnormal noise issues.

Table 7-51 Issues, possible causes, and fixes

Items	Procedures
<i>Symptoms</i>	<i>Possible causes</i>
Computer emits abnormal noise	Aside from basic components (power adapter, supply, fan, speaker, hard drive, optical drive, display panel, external devices), it is also common for electronic components to produce noise. <i>Troubleshooting steps</i> <ol style="list-style-type: none">1. Inspect external power source and change to verified working one.2. Determine whether the noise comes from AC power adapter. Test with a verified working AC adapter. Disconnect external devices and all cables connected to the computer to isolate issue to computer only.
Noisy fan	Determine whether the noise comes from the fan. Disconnect the fan briefly to isolate whether noise originates from fan. If noise is absent with fan disconnected, see Fan runs constantly on page 121 .
Noisy hard drive	Determine whether the noise comes from the hard drive. See Noisy hard drive on page 119 .
Noisy optical drive	<ol style="list-style-type: none">1. Determine whether the noise comes from an optical drive.2. Remove CD/DVD from the optical drive.
Noisy speaker	<ol style="list-style-type: none">1. Determine whether the noise comes from speaker.2. Test with a verified working external headset/speaker.
Noisy display	Determine whether the noise comes from display panel (humming noise). Change display frequency settings. See Display on page 101 .
The section below is intended for authorized service providers and technicians.	
	<ol style="list-style-type: none">1. After disassembling the chassis, inspect components of the interior for excessive wear or damage.2. If noise issues persist, proceed with process of elimination for battery, AC adapter, or boards.

Fan runs constantly

Use this information to troubleshoot a constantly running fan.

Table 7-52 Issues, possible causes, and fixes

Items	Procedures
<i>Symptoms</i>	<i>Possible causes</i>
<ul style="list-style-type: none">• Fan never stops running• Generates heat• Decreased computer performance	<ul style="list-style-type: none">• BIOS not up to date.• Thermal condition (fan, air flow)—fan might not be defective but must run constantly to remove excess heat generated by electrical components.• Inappropriate configuration.
	<i>Troubleshooting steps</i>
	General actions
	<ol style="list-style-type: none">1. Verify whether BIOS is set to Fan Always on while on AC Power F10 Setup. When starting the computer, press f10 to open Setup, and then select Advanced > Built-In Device Options Menu.2. Update BIOS and drivers (4. Update BIOS and drivers on page 69) and reset BIOS to default. BIOS can implement new fan characteristics and updates for other components.3. Perform a hard reset (8. Hard reset on page 75). Performing a hard reset can reset recorded thermal values in memory.
	Thermal-related issue
	<ol style="list-style-type: none">1. Verify that fan is spinning. Reseat fan cable before moving to next step.<ol style="list-style-type: none">a. Check fan and connection. Reseat fan cable.b. Be sure that no obstructions or dust are in heat sink fan, heat sink fin, or vent.c. Test fan using HP PC Hardware Diagnostics (UEFI) tool. Be sure that the fan is not producing loud noise and that fan blades spin correctly.d. Test with a verified working fan.e. Replace the fan.2. Verify thermal solution<p>Use the Thermal Monitor tool in HP PC Hardware Diagnostics (UEFI), which is available only to authorized service providers and technicians, to run a stress test (processor and GPU) and verify that thermal sensors are within limits after thermal condition is serviced.</p>
	User configuration
	Change Power Options in Windows (for example, choosing Balanced mode instead of High performance). High performance and extensive graphics might cause the fan to run constantly to release the heat.
Notes	<p>BIOS currently omits fan presence detection to shorten startup time delay to less than four seconds. Therefore, the fan error is generated based on previous startup to operating system that found system fan error.</p> <p>Fan often is part of thermal solution, including heat sink, heat sink fin/muffler, and thermal grease. Fan replacement requires restart and fan function verification using HP PC Hardware Diagnostics (UEFI) tool.</p>

Thermal shutdown (hot)

Use this information to troubleshoot a thermal shutdown.

Table 7-53 Issues, possible causes, and fixes

Items	Procedures
<i>Symptoms</i>	<i>Possible causes</i>
Similar to fan runs constantly issue (Fan runs constantly on page 121) <ul style="list-style-type: none">• System shutdown• Abnormal heat• Continually running fan• Decreased computer performance	BIOS not up to date, thermal condition (fan, air flow)
	<i>Troubleshooting steps</i>
	<ol style="list-style-type: none">1. Update BIOS and drivers (4. Update BIOS and drivers on page 69) and reset BIOS to default. BIOS can implement new fan characteristics and updates for other components.2. Perform a hard reset (8. Hard reset on page 75). Performing a hard reset can reset recorded thermal values in memory.3. Determine whether you are using a correct AC adapter.4. Be sure to turn power off completely when putting a notebook in a travel bag.
	Thermal-related issue
	<ol style="list-style-type: none">1. Verify thermal condition:<ol style="list-style-type: none">a. Check fan and connection. Check if fan is spinning when computer is on. Reseat fan cable.b. Be sure that no obstructions or dust are in heat sink fan, fin, or vent.c. Be sure that the notebook is not sitting on a hot surface that blocks vent intakes.d. Test fan using HP PC Hardware Diagnostics UEFI tool. Be sure that the fan is not producing a loud noise and that fan blades spin correctly.e. Test with a verified working fan.f. Remove old thermal compound and pads, and replace properly with new pads.2. Verify thermal solution:<p>Use Thermal Monitor tool (available only to authorized service providers and technicians) to run stress test (processor and GPU), and verify that thermal sensors are within limits after thermal condition is serviced.</p>

Additional information

The following sections provide additional information that you can use during the troubleshooting process.

Acronyms

These acronyms are used in this chapter.

Blue screen (BSOD): A Windows error screen that can occur if a problem causes your computer to shut down or restart unexpectedly.

When you experience this type of error, you cannot see items such as the Start menu or the taskbar when your computer is turned on. Instead you might see a blue screen with a message that your computer ran into a problem and needs to restart.

CPU: Central processing unit

DIMM: Dual in-line memory module

Daughter board: Type of circuit board that plugs into or is attached to the system board or similar expansion card to extend its features and services

GPU: Graphics processor unit

GTS: General Troubleshooting Step

HDD: Hard drive

KB: Keyboard

LVDS: Low-Voltage Differential Signaling

MSG: Maintenance and Service Guide

mWS: Mobile Workstations

OS: Operating system

PC: Personal computer

POST: Power-On Self-Test

SSD: Solid-state drive

TSG: Troubleshooting Guide

UEFI: Unified Extensible Firmware Interface

WLAN: Wireless local area network

WS: Workstations

WWAN: Wireless wide area network

Blinking lights and startup error codes

In some cases, when the host processor is not executing code or does not have the necessary code to drive the display, light blink codes inform you of a problem.

Table 7-54 Blinking lights and boot error codes

Blink codes	Error
Amber battery light: blinks 1 Hz continuously	Embedded Controller unable to load firmware

Table 7-54 Blinking lights and boot error codes (continued)

Blink codes	Error
Caps and num lock lights = 1 blink	Processor not executing code
Caps and num lock lights = 2 blinks	BIOS recovery code unable to find valid BIOS recovery image
Caps and num lock lights = 3 blinks	Memory module error
Caps and num lock lights = 4 blinks	Graphics controller error
Caps and num lock lights = 5 blinks	System board error
Caps and num lock lights = 6 blinks	Intel Trusted Execution Technology (TXT) Error
Caps and num lock lights = 7 blinks	Sure Start unable to find valid BIOS Boot Block image
Caps and num lock lights = 8 blinks	Sure Start has identified a problem (Manual Recovery Policy Set)

Processor not executing code

This computer experienced a problem due to the failure of certain code to execute, resulting in a failed startup of the processor.

The issue could be related to the processor or the system board in the computer. If the processor is socketed, be sure that the processor is seated correctly in the socket. If this error reoccurs, see [General troubleshooting steps on page 65](#).

 **NOTE:** The computer attempts to notify you of this problem through a series of blinking lights. When you attempt to turn on the computer from an Off or Hibernated state, lights associated with the **caps lock** and **num lk** keys both **blink once**, followed by a pause, and then continue in a repeating pattern.

BIOS recovery code unable to find valid BIOS recovery image

This computer has experienced a problem in locating a valid BIOS image, resulting in a failed startup.

You can resolve this problem by placing a clean copy of the system BIOS on a USB key or in the appropriate hard drive directory and performing a restart. If this error reoccurs, see [General troubleshooting steps on page 65](#).

 **NOTE:** The computer attempts to notify you of this problem through a series of blinking lights. When you attempt to turn on the computer from an Off or Hibernated state, lights associated with the **caps lock** and **num lock** keys both **blink twice**, followed by a pause, and then continue in a repeating pattern.

Memory module error

This computer has experienced a memory initialization problem resulting in a failed startup. This issue might be related to the memory modules in the computer. You can resolve this problem by ensuring that memory modules are correctly inserted and seated.

If this error reoccurs, you must use a service event to determine the source of the error (memory modules or system board) and take the appropriate corrective action.

 **NOTE:** The computer attempts to notify you of this problem through a series of blinking lights. When you attempt to turn on the computer from an Off or Hibernated state, lights associated with the **caps lock** and **num lock** keys both **blink three times**, followed by a pause, and then continue in a repeating pattern.

Graphics Controller Error (No Controller)

This computer has experienced a graphics controller initialization problem resulting in a failed startup. This issue might be related to the graphics controller in your machine.

You can resolve this problem by ensuring that the graphics controller module is seated correctly in machines with modular graphics. If this error reoccurs, you must use a service event to identify the source of the error and take the appropriate corrective action.

 **NOTE:** The computer attempts to notify you of this problem through a series of blinking lights. When you attempt to turn on the computer from an Off or Hibernated state, lights associated with the **caps lock** and **num lock** keys both **blink four times**, followed by a pause, and then continue in a repeating pattern.

Failure System Board Error

This computer has experienced a system board initialization problem resulting in a failed startup. This issue might be related to the system board in the computer. You must use a service event to identify the source of the error and take the appropriate corrective action.

 **NOTE:** The computer attempts to notify you of this problem through a series of blinking lights. When you attempt to turn on the computer from an Off or Hibernated state, lights associated with the **caps lock** and **num lock** keys both **blink five times**, followed by a pause, and then continue in a repeating pattern.

Intel Trusted Execution Technology (TXT) Error

This computer has experienced a problem related to the Intel Trusted Execution Technology resulting in a failed startup. The error occurs when three situations are true:

- The Intel Trusted Execution Technology (TXT) has been enabled on the computer.
- Policies have been set to prevent startup if the BIOS measurement has changed.
- The BIOS measurement has changed.

For more information about Intel TXT, go to [Intel Trusted Execution Technology](#).

You must use a service event to resolve this issue.

 **NOTE:** The computer attempts to notify you of this problem through a series of blinking lights. When you attempt to turn on the computer from an Off or Hibernated state, lights associated with the **caps lock** and **num lock** keys both **blink six times**, followed by a pause, and then continue in a repeating pattern.

Sure Start unable to find valid BIOS Boot Block image

This computer has experienced a problem in locating a valid BIOS image, resulting in a failed startup. You must use a service event to identify the source of the error and take appropriate corrective action.

 **NOTE:** The computer attempts to notify you of this problem through a series of blinking lights. When you attempt to turn on the computer from an Off or Hibernated state, lights associated with the **caps lock** and **num lock** keys both **blink seven times**, followed by a pause, and then continue in a repeating pattern.

Sure Start has identified a problem (Manual Recovery Policy Set)

This computer has experienced a problem in locating a valid BIOS image, resulting in a failed startup. HP Sure Start normally repairs this type of issue; however, on this computer HP Sure Start has been configured to operate in manual mode key sequence.

To proceed with the repair, press and hold the following keys: **esc + up arrow + down arrow**. To avoid the need for this manual recovery step, set the HP Sure Start recovery policy to automatic. If this error reoccurs, you must use a service event to identify the source of the error and take appropriate corrective action.



NOTE: The computer attempts to notify you of this problem through a series of blinking lights. When you attempt to turn on the computer from an Off or Hibernated state, lights associated with the **caps lock** and **num lk** keys both **blink eight times**, followed by a pause, and then continue in a repeating pattern.

POST error messages and user actions

Use this information to determine the meaning of POST error messages.

Table 7-55 POST error messages and user actions to address the error

Test description	Failure descriptions	Error code	Possible user actions
Product information	Invalid value	00A	Contact support for assistance.
Startup test	Memory module	200	Attempt to reseat the memory module and then repeat the test. Search http://www.hp.com/support for details about troubleshooting issues related to the memory module. If the memory module still fails, contact support.
Startup test	Hard Disk 1 SMART	301	Attempt to reseat the hard drive and repeat the test. The hard disk drive might have failed. Contact support for assistance.
Startup test	Hard Disk 2 SMART	302	The hard drive might have failed. Contact support for assistance.
Startup test	Hard Disk 1 Quick	303	The hard drive might have failed. Contact support for assistance.
Startup test	Hard Disk 2 Quick	304	The hard drive might have failed. Contact support for assistance.
Run-in test	Memory module	200	Attempt to reseat the memory module and then repeat the test. Search http://www.hp.com/support for details about troubleshooting issues related to the memory module. If the memory module still fails, contact support.
Run-in test	Hard Disk 1 SMART	301	Attempt to reseat the hard drive and repeat the test. The hard drive might have failed. Contact support for assistance.
Run-in test	Hard Disk 2 SMART	302	The hard drive might have failed. Contact support for assistance.
Run-in test	Hard Disk 1 Quick	303	The hard drive might have failed. Contact support for assistance.
Run-in test	Hard Disk 2 Quick	304	The hard drive might have failed. Contact support for assistance.
Hard Disk Test	Hard Disk 1 SMART	301	Attempt to reseat the hard drive and repeat the test. The hard drive might have failed. Contact support for assistance.
Hard Disk Test	Hard Disk 2 SMART	302	The hard drive might have failed. Contact support for assistance.

Table 7-55 POST error messages and user actions to address the error (continued)

Test description	Failure descriptions	Error code	Possible user actions
Hard Disk Test	Hard Disk 1 Quick	303	The hard drive might have failed. Contact support for assistance.
Hard Disk Test	Hard Disk 2 Quick	304	The hard drive might have failed. Contact support for assistance.
Hard Disk Test	Hard Disk 1 Full	305	The hard drive might have failed. Contact support for assistance.
Hard Disk Test	Hard Disk 2 Full	306	The hard drive might have failed. Contact support for assistance.
Boot Device Manager	Boot device not found	3F0	This code indicates a potential problem with the hard drive. Run the hard drive test.
Boot Device Manager	Hard Disk 1 Error	3F1	Indicates a potential problem with the hard drive. Run the hard drive test.
Boot Device Manager	Hard Disk 2 Error	3F2	This code indicates a potential problem with the hard drive. Run the hard drive test.
Boot Device Manager	Hard Disk 1 SMART	301	This code indicates a potential problem with the hard drive. Run the hard drive test.
Boot Device Manager	Hard Disk 2 SMART	302	This code indicates a potential problem with the hard drive. Run the hard drive test.
BIOS Recovery	BIOS Recovery Occurred	500	This message indicates that BIOS recovery was completed successfully. No further action is required.
BIOS Application	BIOS Application Error	501	The BIOS installation might have become corrupted. Download the latest version of the BIOS and install it. See 4. Update BIOS and drivers on page 69 for more information. If reinstalling the BIOS fails, contact support for further assistance.
CMOS Recovery	CMOS Recovery Occurred	502	This message indicates that CMOS recovery was completed successfully. No further action is required.
Battery Check	Primary Battery Replace	601	This code indicates that the primary battery has very low capacity. Search http://www.hp.com/support for details about using the HP Support Assistant to verify the battery capacity and, if necessary, order a replacement.
Battery Check	Secondary Battery Replace	602	This indicates that the secondary battery has very low capacity. Search http://www.hp.com/support for details about using the HP Support Assistant to verify the battery capacity and, if necessary, order a replacement.
Wireless Module	Not installed or responding	701	Reseat the wireless LAN adapter module, if your notebook supports it. Seating or reseating a wireless LAN adapter is unique to each computer model.
Fan	Fan not operating correctly	90B	The system fan might be malfunctioning. A hard reset can sometimes restore the system fan to working order. If the system fan continues to malfunction, contact support.

Routine maintenance for performance improvement

The table presents a summary of the suggested times for performing the routine maintenance tasks that are described in this document.

Table 7-56 Routine maintenance tasks to improve performance

Tasks	Weekly	Monthly	Occasionally
Perform a system tuneup.	X		
Run Windows Update.	X		
Scan for and remove viruses.	X		
Scan for and remove spyware and adware.	X		
Empty the Recycle Bin.	X		
Delete temporary Internet files.	X		
Back up user files.		X	
Create a restore point.		X	
Defragment the hard drive.		X	
Run Scan Disk.		X	
Clean the exterior of the computer.			X
Close programs that are not being used.			X
Prevent programs from loading at startup.			X
Remove rear cover and clean fan blades and vents with compressed air.			X

Common blue screen error messages

The following sections define blue screen error messages.

Error message list

For an example of a Bug Check Code Reference, use this image.

For more information, see

[https://msdn.microsoft.com/en-us/library/windows/hardware/hh994433\(v=vs.85\).aspx](https://msdn.microsoft.com/en-us/library/windows/hardware/hh994433(v=vs.85).aspx).

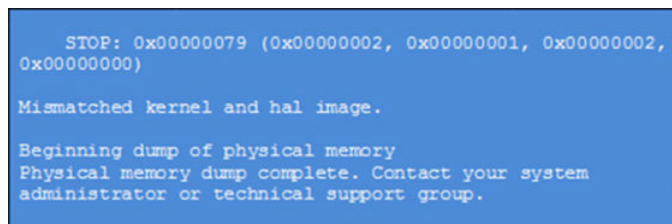

Note that the hexadecimal number following the word *STOP* is called the bug check code or Stop code.

Bug check symbolic names

Each bug check code also has an associated symbolic name.

In the example, the screen shows

[https://msdn.microsoft.com/en-us/library/windows/hardware/ff559209\(v=vs.85\).aspx](https://msdn.microsoft.com/en-us/library/windows/hardware/ff559209(v=vs.85).aspx)

Microsoft general troubleshooting of Windows bug check codes

Use this information to troubleshoot Windows bug codes.

- If you recently added hardware to the system, try removing or replacing it. You can also check with the manufacturer to see if any patches are available.
- Try running HP PC Hardware Diagnostics UEFI.
- Check with the manufacturer to see if an updated system BIOS or firmware is available.
- Be sure that any expansion board is properly seated and all cables are completely connected.
- Confirm that any new hardware that is installed is compatible with the installed version of Windows.
- If new device drivers or system services have been added recently, try removing or updating them.

 **NOTE:** Use safe mode when removing or disabling components. Safe mode loads only the minimum required drivers and system services during the Windows startup. To enter safe mode, restart your computer and press **F8** at the menu that displays the operating system choices. At the resulting **Windows Advanced Options** menu, choose **Safe Mode**.

- Run a virus detection program. Viruses can infect all types of hard drives formatted for Windows, and resulting drive corruption can generate system bug check codes. Be sure that the virus detection program checks the Master Boot Record for infections.
- Verify that the system has the latest service pack installed.
- Disable BIOS memory options such as caching or shadowing.
- Check the System Log and Application Log in Event Viewer to see if any additional error messages have been logged recently. These might pinpoint the cause of the error.

Use Windows Debugging Tool

Debugging Tools for Windows are the primary tools used by Microsoft software developers to analyze and resolve errors that result in memory dumps.

Use the tool ([https://msdn.microsoft.com/library/windows/hardware/ff551063%20\(v=vs.85\).aspx](https://msdn.microsoft.com/library/windows/hardware/ff551063%20(v=vs.85).aspx)) to determine the cause of the error. Follow general steps for downloading, setting up, and using the Windows 10 debugging tool.

 **NOTE:** The following screenshots provide only an example of the tool. Specifics shown are not representative of all applications of the debugging tool. This is a Microsoft tool supported by Microsoft.

Windows Software Development Kit (SDK)

Use these steps to download and use the Windows SDK.

1. Download the SDK from the following link:

<https://dev.windows.com/en-US/downloads/windows-10-sdk>

2. Set up the SDK in the configuration window (Windows 10 shown).

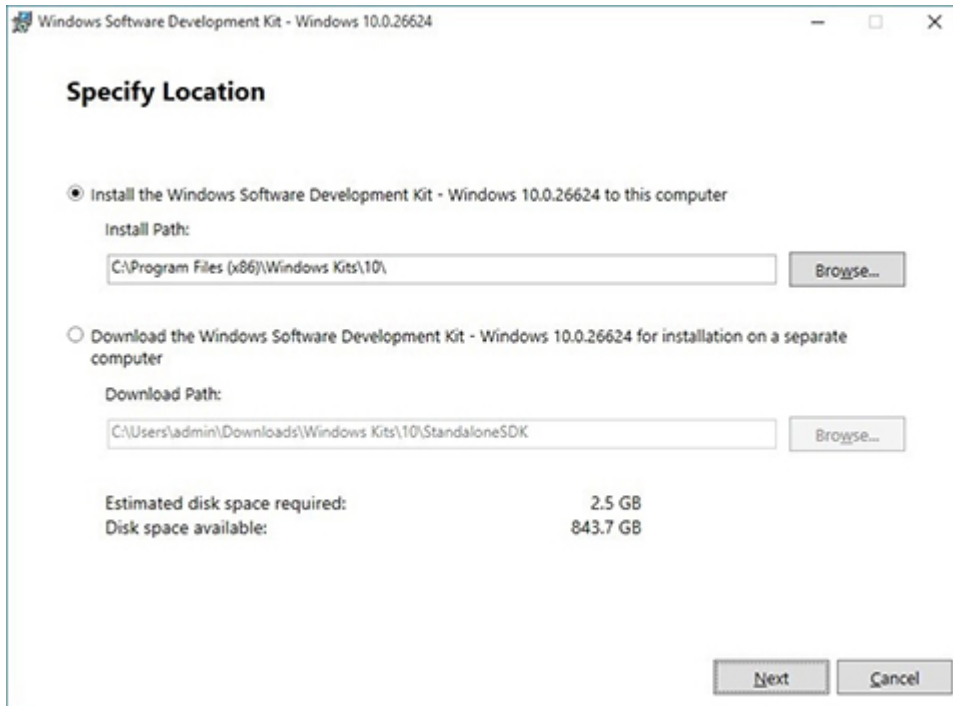

3. Select features to install.

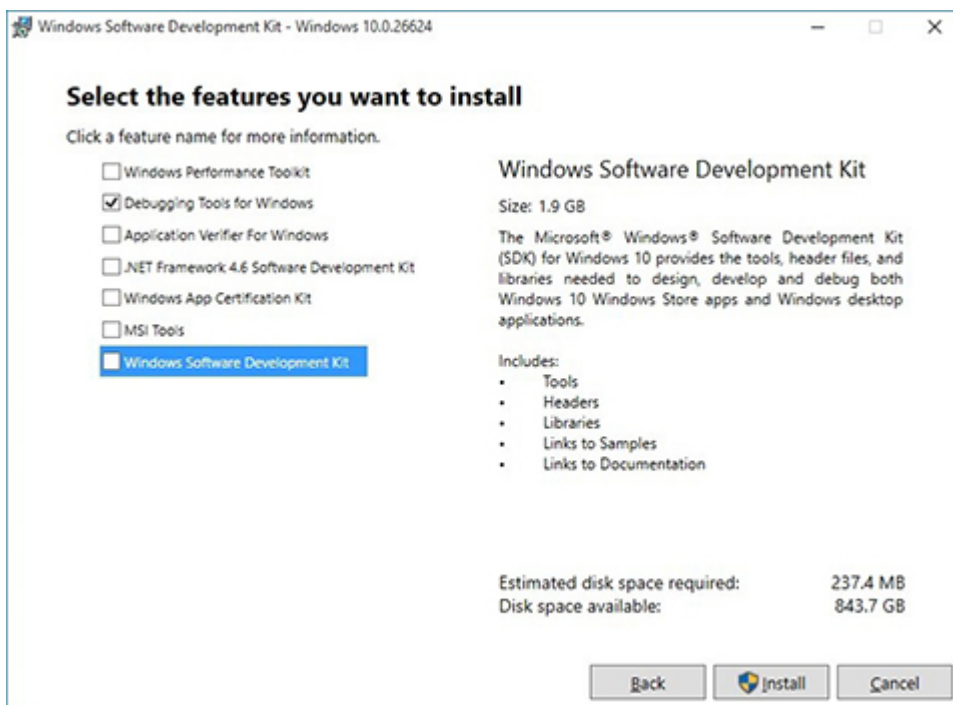

4. Run the SDK as an administrator.



5. Set the symbol path. Select **File > Symbol File Path**.

- In the **Symbol path** box, type `SRV*C:\Windows\symbol_cache*http://msdl.microsoft.com/download/symbols`.
- Save the workspace.

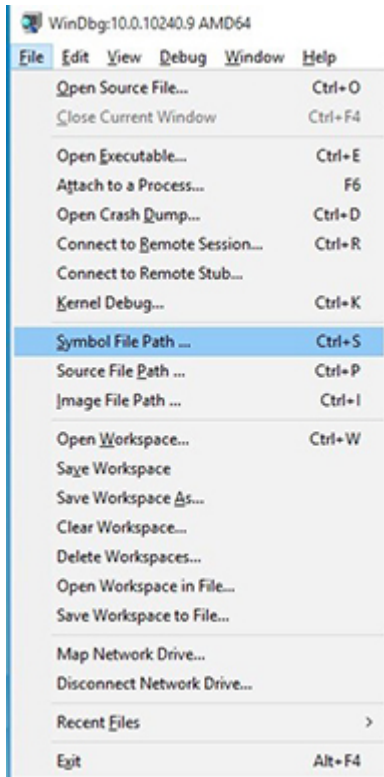

6. Open the crash dump file.

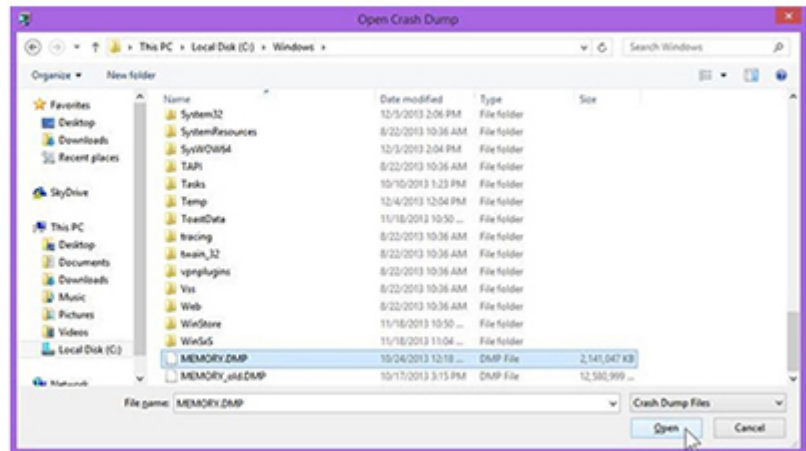
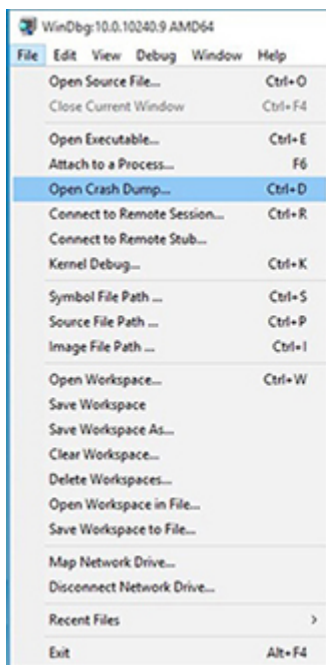

7. Analyze the file. In the following memory dump sample, look for Bug Check 0x3B. The ATIKMAG driver needs to be investigated for further root cause.

Lookup for Bug Check 0xC2.

```

1: kd> !analyze -v
*****
*                                     *
*                               Bugcheck Analysis                               *
*                                     *
*****

SYSTEM_SERVICE_EXCEPTION (3b)
An exception happened while executing a system service routine.
Arguments:
Arg1: 0000000c00000005, Exception code that caused the bugcheck
Arg2: fffff8006d927acf, Address of the instruction which caused the bugcheck
Arg3: fffffd00020e4e500, Address of the context record for the exception that caused the bugcheck
Arg4: 0000000000000000, zero.

Debugging Details:
-----
BUGCHECK_P1: c0000005
BUGCHECK_P2: fffff8006d927acf
BUGCHECK_P3: fffffd00020e4e500
BUGCHECK_P4: 0
EXCEPTION_CODE: (NTSTATUS) 0xc0000005 - The instruction at 0x%p referenced memory at 0x%p. The memory

FAULTING_IP:
atikmpag+2facf
fffff8006d927acf 4539bc2434030000 cmp     dword ptr [r12+334h],r15d
...

SYMBOL_STACK_INDEX: 0
SYMBOL_NAME: atikmpag+2facf
FOLLOWUP_NAME: MachineOwner
MODULE_NAME: atikmpag
IMAGE_NAME: atikmpag.sys
DEBUG_FLR_IMAGE_TIMESTAMP: 55479b42
STACK_COMMAND: .cxr 0xffffd00020e4e500 ; kb
BUCKET_ID_FUNC_OFFSET: 2facf
FAILURE_BUCKET_ID: 0x3b_atikmpag!Unknown_Function
BUCKET_ID: 0x3b_atikmpag!Unknown_Function
PRIMARY_PROBLEM_CLASS: 0x3b_atikmpag!Unknown_Function
ANALYSIS_SOURCE: KM
FAILURE_ID_HASH_STRING: km:0x3b_atikmpag!unknown_function
FAILURE_ID_HASH: {adb00875-801c-005a-68e8-645bb2f2c848}

```

```

Command - Dump C:\Windows\MEMORY.DMP - WinDbg:6.3.9600.16384 AMD64
*****
*                                     *
*                               Bugcheck Analysis                               *
*                                     *
*****

Use !analyze -v to get detailed debugging information.
BugCheck C2, (7. 1205. 1159400. fffff80001137358)
*** ERROR: Module load completed but symbols could not be loaded for nldr.sys
Probably caused by : NETIO.SYS ( NETIO! ?? ::FNODOBFM::'string'+797c )

Followup: MachineOwner
-----
0: kd>

```

Display issue: pixel anomalies

All HP notebook displays adhere to strict quality and reliability specifications. A small percentage of display panels might have minor cosmetic manufacturing anomalies or irregularities such as bright or dark dots in the viewable area. These cosmetic imperfections are common to all display panel types, not specifically HP products.

All display panel defects should be examined at the highest possible resolution using both the brightest and darkest possible backgrounds, because some subpixel failures might not be readily visible under certain conditions.

- Type 1: Bright dot on a dark background = Always On
- Type 2: Dark dot on a bright background = Always Off
- Combination = in any combination and any color that are always on or off

Use the HP PC Hardware Diagnostics (UEFI) tool to determine numbers of pixels and their distance. HP uses the following set of criteria when damaged displays are submitted for warranty coverage.

Table 7-57 Electrical defect criteria

Panel resolution	Accept	Reject
Subpixel faults		
VGA, SVGA, SD, WSVGA, XGA, 720p, SD+, WXGA, HD	$N \leq 2$ Type 1 $N \leq 2$ Type 2	$N \geq 3$ Type 1
WXGA+, SXGA+, HD+, SXGA+	$N \leq 3$ Type 1 $N \leq 3$ Type 2	$N \geq 4$ Type 1
WSXGA+, UXGA, FHD, WUXGA	$N \leq 4$ Type 1 $N \leq 4$ Type 2	$N \geq 5$ Type 1
QHD, QHD+, WQXGA, UD	$N \leq 5$ Type 1 $N \leq 5$ Type 2	$N \geq 6$ Type 1
Electrical defect clusters (defects within a 5 × 5 pixel block)		
Minimum distance between ANY allowable defects (unless otherwise specified)	$S \geq 25$ mm	$S < 25$ mm
Cluster with 2 or more subpixels with subpixel faults		Not allowed
Dim lines		Not allowed
Cross lines on/off		Not allowed
Horizontal lines on/off		Not allowed
Vertical lines on/off		Not allowed

 **NOTE:** Examine all LCD panel defects at the highest possible resolution using both the brightest and darkest possible backgrounds, because some subpixel failures might not be readily visible under certain conditions.

 **NOTE:** Contact support for assistance if issues are not listed.

Cable management

Proper routing of the internal cables is critical to the operation of the computer. Follow good cable management practices when you have to remove and install components.

- Handle cables with care to avoid damage.
- Apply only the tension required to seat or unseat cables during insertion or removal from the connector.
- When possible, handle cables by the connector or pull-strap.

- Route cables in such a way that they cannot be caught or snagged by parts being removed or replaced.
- Keep cables away from direct contact with major heat sources, such as the heat sink. Some air flow guides have a cable guide that lets you route cables safely around the heat sink.
- Do not jam cables on top of daughter boards or memory modules (DIMMs). Circuit cards and DIMMs are not designed to take excessive pressure.
- Keep cables clear of any movable or rotating parts (such as a fan) to prevent them from being cut or crimped when the component is lowered into its normal position.
- In all cases, avoid bending or twisting the cables. Do not bend any cable sharply. A sharp bend can break the internal wires.
- Do not rely on components like the keyboard or service door to push cables down internally. Always position the cables to lie properly by themselves or in the cable guides and chassis areas designed for cable routing.

 **IMPORTANT:** Always release the connector latch before removing the cable. Otherwise, pulling the cable could damage the cable pins and result in a failed device.

Connector types

There are several types of connectors on the system board with different requirements for cable removal or insertion.

 **IMPORTANT:** Do not touch connector pins and connector gold fingers directly with bare hands.

Flex cable

Use this information to properly use flex cables.

When connecting flex cables to a ZIF connector, rotate the latch to 90°, push the cable completely, evenly into the connector, and then close the latch.

When removing flex cables from a ZIF connector on the system board, you must release the latch before removing the cable. Always follow these steps:

1. Flip the connector latch 90° to release the cable.
2. Grasp the cable end of the connector and pull it straight out.

 **IMPORTANT:** Always release the connector latch before removing the cable. Otherwise, pulling the cable could damage the cable pins and result in a failed device.

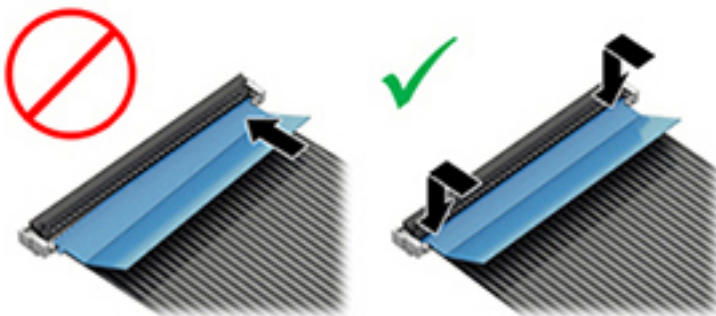

Horizontal cable insertion

Use a flat tool to pull the connector evenly. Do not pull on cable to remove.

Slide connector into receptacle on same horizontal plane as board and use a flat tool to push evenly into receptacle.

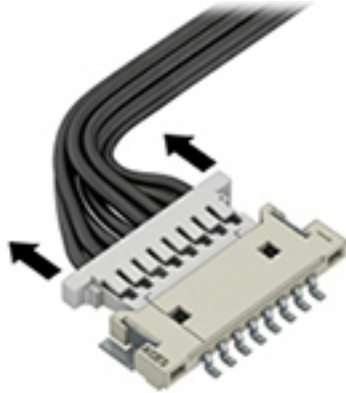

Multiple-pin horizontal connector (LVDS cable to display panel)

Use these procedures to properly insert and remove a multiple-pin horizontal connector.

Insert procedure:

1. Slide connector evenly into receptacle on same horizontal plane as PCB connector.
2. Pull lock bar to insert and push both sides of connector horizontally to firmly lock.
3. Tape down lock bar over the panel to hold in position.

Reverse the previous procedure to remove the connector:

1. Remove tape.
2. Pull up bar (pull tape) and release the lock with the PCB connector.
3. Pull to the direction in parallel with PCB to withdraw the connector.

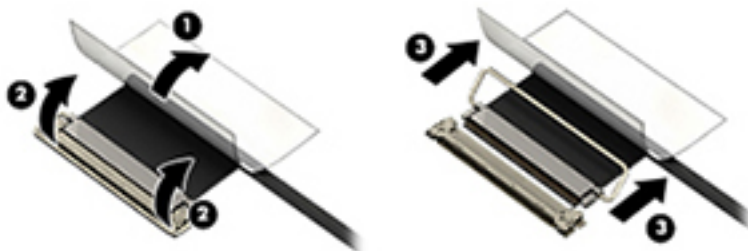

Multiple-pin vertical connector (LVDS cable to system board)

Use this procedure to properly insert and remove a multiple-pin vertical connector.

- Remove the connector gasket before removing the connector.

- If the connector has a plastic pull tab, pull the tab to disconnect. Otherwise, use a flat tool under the connector to remove evenly. Do not pull on the cable to remove.
- Press evenly when reseating, reconnecting, or installing the connector.

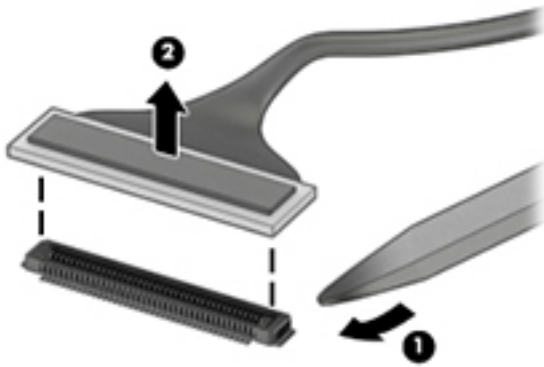

For more information about cable management, see [Cable management on page 134](#).

8 Using Setup Utility (BIOS)

Setup Utility, or Basic Input/Output System (BIOS), controls communication between all the input and output devices on the system (such as disk drives, display, keyboard, mouse, and printer). Setup Utility (BIOS) includes settings for the types of devices installed, the startup sequence of the computer, and the amount of system and extended memory.



NOTE: To start Setup Utility on convertible computers, your computer must be in notebook mode and you must use the keyboard attached to your notebook.

Starting Setup Utility (BIOS)

You have several ways to access the Setup Utility (BIOS).



IMPORTANT: Use extreme care when making changes in Setup Utility (BIOS). Errors can prevent the computer from operating properly.

Use one of these options:

- Turn on or restart the computer and quickly press **f10**.
- Turn on or restart the computer, quickly press **esc**, and then press **f10** when the Start menu is displayed.

Updating Setup Utility (BIOS)

Updated versions of Setup Utility (BIOS) might be available on the HP website. Most BIOS updates on the HP website are packaged in compressed files called *SoftPaqs*. Some download packages contain a file named `Readme.txt`, which contains information regarding installing and troubleshooting the file.

Determining the BIOS version

To decide whether you need to update Setup Utility (BIOS), first determine the BIOS version on your computer.

To reveal the BIOS version information (also known as *ROM date* and *System BIOS*), use one of these options.

- HP Support Assistant
 1. Perform one of these tasks:
 - Select the **Search** icon in the taskbar, type `support` in the search box, and then select the **HP Support Assistant** app.
 - Select the question mark icon in the taskbar.
 2. Under **My notebook**, select **Specifications**.
- Setup Utility (BIOS)

1. Start Setup Utility (BIOS) (see [Starting Setup Utility \(BIOS\) on page 138](#)).
 2. Select **Main**, and then make note of the BIOS version.
 3. Select **Exit**, select one of the options, and then follow the on-screen instructions.
- In Windows, press **ctrl+alt+s**.

To check for later BIOS versions, see [Preparing for a BIOS update on page 139](#).

Preparing for a BIOS update

Be sure to follow all prerequisites before downloading and installing a BIOS update.

 **IMPORTANT:** To reduce the risk of damage to the computer or an unsuccessful installation, download and install a BIOS update only when the computer is connected to reliable external power using the HP AC adapter provided with the computer (select products only), a replacement AC adapter provided by HP, or an AC adapter with the power rating specified on the product label. Do not download or install a BIOS update while the computer is running on battery power, docked in an optional docking device, or connected to an optional power source. During the download and installation, follow these instructions:

- Do not disconnect power from the computer by unplugging the power cord from the AC outlet.
- Do not shut down the computer or initiate Sleep.
- Do not insert, remove, connect, or disconnect any device, cable, or cord.

 **NOTE:** If your computer is connected to a network, consult the network administrator before installing any software updates, especially system BIOS updates.

Downloading a BIOS update

After you review the prerequisites, you can check for and download BIOS updates.

1. Perform one of these tasks:
 - Select the **Search** icon in the taskbar, type `support` in the search box, and then select the **HP Support Assistant** app.
 - Select the question mark icon in the taskbar.
2. Select **Updates**. The **Checking for Updates** window opens, and Windows checks for updates.
3. Follow the on-screen instructions.
4. At the download area, follow these steps:
 - a. Identify the most recent BIOS update and compare it to the BIOS version currently installed on your computer. If the update is more recent than your BIOS version, make a note of the date, name, or other identifier. You might need this information to locate the update later, after it has been downloaded to your hard drive.
 - b. Follow the on-screen instructions to download your selection to the hard drive.

Make a note of the path to the location on your hard drive where the BIOS update is downloaded. You will need to access this path when you are ready to install the update.

Installing a BIOS update

BIOS installation procedures vary. Follow any instructions that appear on the screen after the download is complete. If no instructions appear, follow these steps.

1. Select the **Search** icon in the taskbar, type `file` in the search box, and then select **File Explorer**.
2. Select your hard drive designation. The hard drive designation is typically Local Disk (C:).
3. Using the hard drive path you recorded earlier, open the folder that contains the update.
4. Double-click the file that has an .exe extension (for example, *filename.exe*).

The BIOS installation begins.

5. Complete the installation by following the on-screen instructions.



NOTE: After a message on the screen reports a successful installation, you can delete the downloaded file from your hard drive.

9 Computer Setup (BIOS), TPM, and HP Sure Start

HP provides several tools to help set up and protect your computer.

Using Computer Setup

Computer Setup, or Basic Input/Output System (BIOS), controls communication between all the input and output devices on the system (such as hard drives, display, keyboard, mouse, and printer). Computer Setup includes settings for types of devices installed, the startup sequence of the computer, and amount of system and extended memory.

 **NOTE:** Use extreme care when making changes in Computer Setup. Errors can prevent the computer from operating properly.

To start Computer Setup, turn on or restart the computer, and when the HP logo appears, press **F10** to enter Computer Setup.

Navigating and selecting in Computer Setup

You can navigate and select in Computer Setup using one or more methods.

- To select a menu or a menu item, use the **tab** key and the keyboard arrow keys and then press **enter**, or use a pointing device to select the item.
- To scroll up and down, select the up arrow or the down arrow in the upper-right corner of the screen, or use the up arrow key or the down arrow key on the keyboard.
- To close open dialog boxes and return to the main Computer Setup screen, press **esc**, and then follow the on-screen instructions.

To exit Computer Setup, choose one of the following methods:

- To exit Computer Setup menus without saving your changes, select **Main**, select **Ignore Changes and Exit**, and then select **Yes**.

 **NOTE:** If you are using arrow keys to highlight your choice, you must then press **enter**.

- To save your changes and exit Computer Setup menus, select **Main**, select **Save Changes and Exit**, and then select **Yes**.

 **NOTE:** If you are using arrow keys to highlight your choice, you must then press **enter**.

Your changes go into effect when the computer restarts.

Restoring factory settings in Computer Setup

To return all settings in Computer Setup to the values that were set at the factory, follow these steps.

 **NOTE:** Restoring defaults will not change the hard drive mode.

1. Start Computer Setup. See [Using Computer Setup on page 141](#).
2. Select **Main**, select **Apply Factory Defaults and Exit**, and then select **Yes**.

 **NOTE:** If you are using arrow keys to highlight your choice, you must then press **enter**.

 **NOTE:** On select products, the selections might display **Restore Defaults** instead of **Apply Factory Defaults and Exit**.

Your changes go into effect when the computer restarts.

 **NOTE:** Your password settings and security settings are not changed when you restore the factory settings.

Updating the BIOS

Updated versions of the BIOS might be available on the HP website. Most BIOS updates on the HP website are packaged in compressed files called *SoftPaqs*.

Some download packages contain a file named Readme.txt, which contains information regarding installing and troubleshooting the file.

Determining the BIOS version

To decide whether you need to update Computer Setup (BIOS), first determine the BIOS version on your computer.

If you are already in Windows, you can access BIOS version information (also known as *ROM date* and *System BIOS*) by pressing **fn+esc** (select products only). Or you can use Computer Setup.

1. Start Computer Setup. See [Using Computer Setup on page 141](#).
2. Select **Main**, and then select **System Information**.
3. To exit Computer Setup menus without saving your changes, select **Main**, select **Ignore Changes and Exit**, and then select **Yes**.

 **NOTE:** If you are using arrow keys to highlight your choice, you must then press **enter**.

To check for later BIOS versions, see [Preparing for a BIOS update on page 142](#).

Preparing for a BIOS update

Be sure to follow all prerequisites before downloading and installing a BIOS update.

 **IMPORTANT:** To reduce the risk of damage to the computer or an unsuccessful installation, download and install a BIOS update only when the computer is connected to the following types of reliable external power:

- The HP AC adapter provided with the computer (select products only)
 - A replacement AC adapter provided by HP
 - An AC adapter with the power rating specified on the product label
-

Do not download or install a BIOS update while the computer is operating under these circumstances:

- Running on battery power

- Docked in an optional docking device
- Connected to an optional docking power source

During the download and installation, follow these instructions:

- Do not disconnect power on the computer by unplugging the power cord from the AC outlet.
- Do not shut down the computer or initiate Sleep.
- Do not insert, remove, connect, or disconnect any device, cable, or cord.

Downloading a BIOS update

After you review the prerequisites, you can check for and download BIOS updates.

1. Perform one of these tasks:
 - Select the **Search** icon in the taskbar, type `support` in the search box, and then select the **HP Support Assistant** app.
 - Select the question mark icon (select products only) in the taskbar.
2. Select **Updates**, and then select **Check for updates and messages**.
3. Follow the on-screen instructions.
4. At the download area, follow these steps:
 - a. Identify the most recent BIOS update and compare it to the BIOS version currently installed on your computer. Make a note of the date, name, or other identifier. You might need this information to locate the update later, after it has been downloaded to your hard drive.
 - b. Follow the on-screen instructions to download your selection to the hard drive.

Make a note of the path to the location on your hard drive where the BIOS update is downloaded. You will need to access this path when you are ready to install the update.



NOTE: If you connect your computer to a network, consult the network administrator before installing any software updates, especially system BIOS updates.

Installing a BIOS update

BIOS installation procedures vary. Follow any instructions that are displayed on the screen after the download is complete. If no instructions are displayed, follow these steps.

1. Select the **Search** icon in the taskbar, type `file` in the search box, and then select **File Explorer**.
2. Select your hard drive designation. The hard drive designation is typically Local Disk (C:).
3. Using the hard drive path you recorded earlier, open the folder that contains the update.
4. Double-click the file that has an `.exe` extension (for example, `filename.exe`).
The BIOS installation begins.
5. Complete the installation by following the on-screen instructions.



NOTE: After a message on the screen reports a successful installation, you can delete the downloaded file from your hard drive.

Changing the boot order using the f9 prompt

To dynamically choose a boot device for the current startup sequence, follow these steps.

1. Access the Boot Device Options menu:
 - Turn on or restart the computer, and when the HP logo appears, press **f9** to enter the Boot Device Options menu.
2. Select a boot device, press **enter**, and then follow the on-screen instructions.

TPM BIOS settings (select products only)

Trusted Platform Module (TPM) provides additional security for your computer. You can modify the TPM settings in Computer Setup (BIOS).

 **IMPORTANT:** Before enabling TPM functionality on this system, you must ensure that your intended use of TPM complies with relevant local laws, regulations and policies, and approvals or licenses must be obtained if applicable. For any compliance issues arising from your operation or usage of TPM that violates the previously mentioned requirement, you shall bear all the liabilities wholly and solely. HP will not be responsible for any related liabilities.

 **NOTE:** If you change the TPM setting to Hidden, TPM is not visible in the operating system.

To access TPM settings in Computer Setup:

1. Start Computer Setup. See [Using Computer Setup on page 141](#).
2. Select **Security**, select **TPM Embedded Security**, and then follow the on-screen instructions.

Using HP Sure Start (select products only)

Select computer models are configured with HP Sure Start, a technology that monitors the computer's BIOS for attacks or corruption. If the BIOS becomes corrupted or is attacked, HP Sure Start automatically restores the BIOS to its previously safe state, without user intervention.

HP Sure Start is configured and already enabled so that most users can use the HP Sure Start default configuration. Advanced users can customize the default configuration.

To access the latest documentation on HP Sure Start, go to <http://www.hp.com/support>. Select **Find your product**, and then follow the on-screen instructions.

10 Backing up, resetting, and recovering

This chapter provides information about processes that are standard procedure for most products.

Backing up

You can back up your data to an optional USB flash drive or SD memory card or through Google Drive.

For detailed information about creating a backup, go to <http://www.support.google.com>.

Resetting

A factory reset erases all the information on your computer hard drive, including all the files in the Downloads folder. Before you reset, back up your files to an optional USB flash drive, SD memory card, or through Google Drive. The factory reset will not delete any of your files on Google Drive or an external storage device.

 **IMPORTANT:** Resetting permanently erases everything on your computer hard drive, including your downloaded files. If possible, back up your files before you reset your computer.

You might want to reset your computer in the following circumstances:

- You see the message "Reset this Chrome device."
- You are having problems with your user profile or settings.
- You have tried restarting your computer, and it is still not working properly.
- You want to change the owner of your computer.

To reset your computer:

1. Under the **Settings** menu, click **Advanced**.
2. In the **Powerwash** section, click **Powerwash**.
3. Click **Restart**, and then sign in with your Google Account.

 **NOTE:** The account you sign in with after you reset your computer will be recognized as the owner account.

4. Follow the on-screen instructions to reset your computer.
5. Once you complete the reset, you can set up your computer and check to see whether the problem is fixed.

Recovering

When your ChromeOS™ operating system is not working properly, you can perform a recovery. A recovery reinstalls the operating system and software programs and restores the original factory

settings. Locally saved files and saved networks are deleted for all accounts. Your Google Accounts and any data synced to your Google Drive™ storage are not affected by a system recovery.



NOTE: For more information about performing a system recovery on your computer, go to <http://www.support.google.com>

Before beginning the recovery process, you need the following:

- A USB flash drive or SD memory card with a capacity of 4 GB or greater. All data is erased from this storage device when the recovery media is created, so back up any files from the device before you begin.
- A computer with internet access. You must also have administrative rights to the computer.
- Computer AC adapter. The computer must be plugged into AC power during recovery.
- The “ChromeOS is missing or damaged” screen displaying on your computer. If this message is not already displayed:
 - Turn on the computer, press and hold the **esc + f3** keys, and then press the power button. The computer restarts, and the screen shows the “ChromeOS is missing or damaged” screen.

Installing the Chromebook Recovery Utility

The Chromebook™ Recovery Utility is an app used to recover the original operating system and software programs that were installed at the factory. You can install this utility from the Chrome Web Store on any computer.

To install the Chromebook Recovery Utility:

- Open the Chrome Web Store, search for , click **Chromebook Recovery Utility** from the Apps list, and follow the on-screen instructions.

Creating recovery media

Recovery media is used to recover the original operating system and software programs that were installed at the factory.

To create recovery media:

1. Turn on a computer with Internet access.



NOTE: You must have administrative rights to the computer.

2. Click the **Launcher** icon, and then click **All Apps**.
3. In the Apps window, click **Recovery**, and then click **Get started**.
4. Follow the on-screen instructions to create the recovery media.





NOTE: All data and partitions on your recovery media will be deleted. Do not remove the USB flash drive or SD memory card until the process is complete.

Recovering the Chrome operating system

To recover the Chrome operating system on your computer using the recovery media you created:

1. Disconnect any external devices connected to your computer, plug in the power cord, and then turn on the computer.
2. To enter recovery mode, press and hold **esc + f3**, and then press the power button. When the “ChromeOS is missing or damaged” screen displays, insert the recovery media into your computer. The recovery process begins immediately.
3. Wait while Chrome verifies the integrity of the recovery media.

 **NOTE:** If you need to cancel the recovery during the verification process, press and hold the power button until the computer turns off. Do not disrupt the system recovery process after the verification step is complete.

 **NOTE:** If an error message displays, you might need to run the Chrome Recovery Utility again, or use a different USB flash drive or SD memory card.

4. When the “System Recovery is complete” message displays, remove the recovery media.
The computer restarts with ChromeOS reinstalled.

Setting up your computer after a reset or recovery

After a reset or recovery is complete, perform the initial setup process.

For details on setting up the computer, go to <http://www.support.google.com>.

Erase and reformat the recovery media

During the process of creating recovery media, the USB flash drive or SD memory card is formatted for use as a recovery tool. After you recover your computer, you must to erase the recovery media if you want to reuse your USB flash drive or SD memory card to store other files. Use the steps in this section to erase the recovery media using the Chromebook Recovery Utility.

1. Click the **Launcher** icon, and then click **All Apps**.
2. In the apps window, click **Recovery**.
3. Click the **Settings** icon, and then click **Erase recovery media**.
4. Select the USB flash drive or SD memory card you inserted, click **Continue**, and then click **Erase now**.
5. After the recovery media is erased, click **Done** to close the Chromebook Recovery Utility, and then remove the USB flash drive or SD memory card.

The media is ready to be formatted using a formatting tool provided by your operating system.

11 Backing up, restoring, and recovering

You can use Windows tools or HP software to back up your information, create a restore point, reset your computer, create recovery media, or restore your computer to its factory state. Performing these standard procedures can return your computer to a working state faster.

 **IMPORTANT:** If you are performing recovery procedures on a tablet, the tablet battery must be at least 70% charged before you start the recovery process.

 **IMPORTANT:** For a tablet with a detachable keyboard, connect the tablet to the keyboard base before beginning any recovery process.

Backing up information and creating recovery media

These methods of creating recovery media and backups are available on select products only.

Using Windows tools for backing up

HP recommends that you back up your information immediately after initial setup. You can do this task either using Windows Backup locally with an external USB flash drive or using online tools.

 **NOTE:** If computer storage is 32 GB or less, Microsoft System Restore is disabled by default.

Using the HP Cloud Recovery Download Tool to create a recovery USB flash drive (select products only)

You can use the HP Cloud Recovery Download Tool to create an HP Recovery bootable USB flash drive.

For details:

- Go to <http://www.hp.com>, search for HP Cloud Recovery, and then select the result that matches the type of computer that you have and follow the on-screen instructions.

 **NOTE:** In select countries, if you cannot create the HP Recovery USB flash drive yourself, contact support. Go to <http://www.hp.com/support>, select your country or region, and then follow the on-screen instructions.

 **IMPORTANT:** HP recommends that you follow the [Restoring and recovery methods on page 149](#) to restore your computer before you obtain and use the HP USB flash drive. Using a recent backup can return your machine to a working state sooner than using the HP USB flash drive. After the system is restored, reinstalling all the operating system software released since your initial purchase can be a lengthy process.

Restoring and recovering your system

You have several tools available to recover your system both within and outside of Windows if the desktop cannot load.

HP recommends that you attempt to restore your system using the [Restoring and recovery methods on page 149](#).

Creating a system restore

System Restore is available in Windows. The System Restore software can automatically or manually create restore points, or snapshots, of the system files and settings on the computer at a particular point.

When you use System Restore, it returns your computer to its state at the time you made the restore point. Your personal files and documents should not be affected.

Restoring and recovery methods

After you run the first method, test to see whether the issue still exists before you proceed to the next method, which might now be unnecessary.

1. Run a Microsoft System Restore.
2. Run Reset this PC.

 **NOTE:** The options **Remove everything** and then **Fully clean the drive** can take several hours to complete and leave no information on your computer. It is the safest way to reset your computer before you recycle it.

3. Recover using the HP Recovery USB flash drive. For more information, see [Recovering using the HP Recovery USB flash drive on page 149](#).

For more information about the first two methods, see the Get Help app:

- Select the **Start** button, select **All apps**, select the **Get Help** app, and then enter the task you want to perform.

 **NOTE:** You must be connected to the internet to access the Get Help app.

Recovering using the HP Recovery USB flash drive

You can use the HP Recovery USB flash drive to recover the operating system and drivers that were installed at the factory. On select products, you can create recovery media on a bootable USB flash drive using the HP Cloud Recovery Download Tool.

For details, see [Using the HP Cloud Recovery Download Tool to create a recovery USB flash drive \(select products only\) on page 148](#).

 **NOTE:** In select countries, if you cannot create the HP Recovery USB flash drive yourself, contact support. Go to <http://www.hp.com/support>, select your country or region, and then follow the on-screen instructions.

To recover your system:

- Insert the HP Recovery USB flash drive, and then restart the computer.

 **NOTE:** HP recommends that you follow the [Restoring and recovery methods on page 149](#) to restore your computer before you obtain and use the HP USB flash drive. Using a recent backup can return your machine to a working state sooner than using the HP USB flash drive. After the system is restored, reinstalling all the operating system software released since your initial purchase can be a lengthy process.

Changing the computer boot order

If your computer does not restart using the HP Recovery USB flash drive, you can change the computer boot order, which is the order of devices listed in BIOS for startup information.

 **IMPORTANT:** For a tablet with a detachable keyboard, connect the tablet to the keyboard base before beginning these steps.

To change the boot order:

1. Insert the HP Recovery USB flash drive.
2. Access the system **Startup** menu.
 - For computers or tablets with keyboards attached, turn on or restart the computer or tablet, quickly press **esc**, and then press **f9** for boot options.
 - For tablets without keyboards, turn on or restart the tablet, and then quickly press and hold one of the following buttons:
 - Volume up
 - Volume down

Then select **f9**.
3. Select the USB flash drive to boot from, and then follow the on-screen instructions.

Using HP Sure Recover (select products only)

Select computer models are configured with HP Sure Recover, a PC operating system (OS) recovery solution built into the hardware and software. HP Sure Recover can fully restore the HP OS image without installed recovery software.

Using HP Sure Recover, an administrator or user can restore the system and install:

- Latest version of the OS
- Platform-specific device drivers
- Software applications, in the case of a custom image

To access the latest documentation for HP Sure Recover, go to <http://www.hp.com/support>. Follow the on-screen instructions to find your product and locate your documentation.

12 Using HP PC Hardware Diagnostics

You can use the HP PC Hardware Diagnostics utility to determine whether your computer hardware is running properly. The three versions are HP PC Hardware Diagnostics Windows, HP PC Hardware Diagnostics UEFI (Unified Extensible Firmware Interface), and (for select products only) Remote HP PC Hardware Diagnostics UEFI, a firmware feature.

Using HP PC Hardware Diagnostics Windows (select products only)

HP PC Hardware Diagnostics Windows is a Windows-based utility that allows you to run diagnostic tests to determine whether the computer hardware is functioning properly. The tool runs within the Windows operating system to diagnose hardware failures.

If HP PC Hardware Diagnostics Windows is not installed on your computer, you must download and install it. To download HP PC Hardware Diagnostics Windows, see [Downloading HP PC Hardware Diagnostics Windows on page 152](#).

Using an HP PC Hardware Diagnostics Windows hardware failure ID code

When HP PC Hardware Diagnostics Windows detects a failure that requires hardware replacement, a 24-digit failure ID code is generated for select component tests. For interactive tests, such as keyboard, mouse, or audio and video palette, you must perform troubleshooting steps before you can receive a failure ID.

You have several options after you receive a failure ID:

- Select **Next** to open the Event Automation Service (EAS) page, where you can log the case.
- Scan the QR code with your mobile device, which takes you to the EAS page, where you can log the case.
- Select the box next to the 24-digit failure ID to copy your failure code and send it to support.

Accessing HP PC Hardware Diagnostics Windows

After HP PC Hardware Diagnostics Windows is installed, you can access it from HP Support Assistant or the Start menu.

Accessing HP PC Hardware Diagnostics Windows from HP Support Assistant (select products only)

After HP PC Hardware Diagnostics Windows is installed, follow these steps to access it from HP Support Assistant.

1. Complete one of the following tasks:
 - Select the **Search** icon in the taskbar, type `support` in the search box, and then select the **HP Support Assistant** app.
 - Select the question mark icon in the taskbar.

2. Select **Fixes & Diagnostics**.
3. Select **Run hardware diagnostics**, and then select **Launch**.
4. When the tool opens, select the type of diagnostic test that you want to run, and then follow the on-screen instructions.



NOTE: To stop a diagnostic test, select **Cancel**.

Accessing HP PC Hardware Diagnostics Windows from the Start menu (select products only)

After HP PC Hardware Diagnostics Windows is installed, follow these steps to access it from the Start menu.

1. Select the **Start** button, and then select **All apps**.
2. Select **HP PC Hardware Diagnostics Windows**.
3. When the tool opens, select the type of diagnostic test that you want to run, and then follow the on-screen instructions.



NOTE: To stop a diagnostic test, select **Cancel**.

Downloading HP PC Hardware Diagnostics Windows

The HP PC Hardware Diagnostics Windows downloading instructions are provided in English only. You must use a Windows computer to download this tool because only .exe files are provided.

Downloading the latest HP PC Hardware Diagnostics Windows version from HP

To download HP PC Hardware Diagnostics Windows from HP, follow these steps.

1. Go to <http://www.hp.com/go/techcenter/pcdiags>. The HP PC Diagnostics home page is displayed.
2. Select **Diagnose PC Hardware issues in Windows**, scroll down to the expanded window that appears, and then select **Download**.
3. A pop-up that asks what you want to do with the file opens. Select **Open** or **Save As**. The latest version of the diagnostics tool opens or downloads to the selected location.

Downloading the HP PC Hardware Diagnostics Windows from the Microsoft Store

You can download the HP PC Hardware Diagnostics Windows from the Microsoft Store.

1. Select the Microsoft Store app on your desktop or select the **Search** icon in the taskbar, and then type `Microsoft Store` in the search box.
2. Type `HP PC Hardware Diagnostics Windows` in the **Microsoft Store** search box.
3. Follow the on-screen directions.

The tool downloads to the selected location.

Downloading HP Hardware Diagnostics Windows by product name or number (select products only)

You can download HP PC Hardware Diagnostics Windows by product name or number.

 **NOTE:** For some products, you might have to download the software to a USB flash drive by using the product name or number.

1. Go to <http://www.hp.com/support>.
2. Select **Software and Drivers**, select your type of product, and then enter the product name or number in the search box that is displayed.
3. In the **Diagnostics** section, select **Download**, and then follow the on-screen instructions to select the specific Windows diagnostics version to be downloaded to your computer or USB flash drive.

The tool downloads to the selected location.

Installing HP PC Hardware Diagnostics Windows

To install HP PC Hardware Diagnostics Windows, navigate to the folder on your computer or the USB flash drive where the .exe file downloaded, double-click the .exe file, and then follow the on-screen instructions.

Using HP PC Hardware Diagnostics UEFI

HP PC Hardware Diagnostics Unified Extensible Firmware Interface (UEFI) allows you to run diagnostic tests to determine whether the computer hardware is functioning properly. The tool runs outside the operating system so that it can isolate hardware failures from issues that are caused by the operating system or other software components.

 **NOTE:** For some products, you must use a Windows computer and a USB flash drive to download and create the HP UEFI support environment because only .exe files are provided. For more information, see [Downloading HP PC Hardware Diagnostics UEFI to a USB flash drive on page 154](#).

If your PC does not start in Windows, you can use HP PC Hardware Diagnostics UEFI to diagnose hardware issues.

Using an HP PC Hardware Diagnostics UEFI hardware failure ID code

When HP PC Hardware Diagnostics UEFI detects a failure that requires hardware replacement, a 24-digit failure ID code is generated.

For assistance in solving the problem, complete one of these tasks:

- Select **Contact HP**, accept the HP privacy disclaimer, and then use a mobile device to scan the failure ID code that appears on the next screen. The HP Customer Support - Service Center page appears with your failure ID and product number automatically filled in. Follow the on-screen instructions.
- Contact support, and provide the failure ID code.

Starting HP PC Hardware Diagnostics UEFI

To start HP PC Hardware Diagnostics UEFI, follow this procedure.

1. Turn on or restart the computer, and quickly press **esc**.
2. Press **f2**.

The BIOS searches three places for the diagnostic tools, in the following order:

- a. Connected USB flash drive



NOTE: To download the HP PC Hardware Diagnostics UEFI tool to a USB flash drive, see [Downloading the latest HP PC Hardware Diagnostics UEFI version on page 155](#).

- b. Hard drive

- c. BIOS

3. When the diagnostic tool opens, select the type of diagnostic test that you want to run, and then follow the on-screen instructions.

Starting HP PC Hardware Diagnostics UEFI through HP Hotkey Support software (select products only)

This section describes how to start HP PC Hardware Diagnostics UEFI through HP Hotkey Support software.



NOTE: You must disable Fast Boot to access HP PC Hardware Diagnostics UEFI from the HP System Information application.

To disable Fast Boot:

1. Turn on or restart the computer, and when the HP logo appears, press **f10** to enter Computer Setup.
2. Select **Advanced**, and then select **Boot Options**.
3. Clear **Fast Boot**.
4. Select **Save Changes and Exit**, and then select **Yes**.

To start HP PC Hardware Diagnostics UEFI through HP Hotkey Support software, follow this procedure:

1. From the **Start** menu, open the HP System Information Application or press **fn+esc**.
2. In HP System Information screen, select **Run System Diagnostics**, select **Yes** to run the application, and then select **Restart**.



IMPORTANT: To prevent loss of data, save your work in all open apps before restarting your computer.



NOTE: When the restart is complete, the computer opens the HP PC Hardware Diagnostics UEFI Application. Proceed with the troubleshooting tests.

Downloading HP PC Hardware Diagnostics UEFI to a USB flash drive

Downloading HP PC Hardware Diagnostics UEFI to a USB flash drive can be useful in some situations.

- HP PC Hardware Diagnostics UEFI is not included in the preinstallation image.
- HP PC Hardware Diagnostics UEFI is not included in the HP Tool partition.

- The hard drive is damaged.

 **NOTE:** The HP PC Hardware Diagnostics UEFI downloading instructions are provided in English only, and you must use a Windows computer to download and create the HP UEFI support environment because only .exe files are provided.

Downloading the latest HP PC Hardware Diagnostics UEFI version

To download the latest HP PC Hardware Diagnostics UEFI version to a USB flash drive, follow these steps.

1. Go to <http://www.hp.com/go/techcenter/pcdiags>. The HP PC Diagnostics home page is displayed.
2. Select **Diagnose PC Hardware Issues outside of the OS**, scroll down to the expanded window that appears, and then select **Download**.
3. A pop-up that asks what you want to do with the file opens. Select **Open** or **Save As**. The latest version of the diagnostics tool opens or downloads to the selected location.

Downloading HP PC Hardware Diagnostics UEFI by product name or number (select products only)

You can download HP PC Hardware Diagnostics UEFI by product name or number (select products only) to a USB flash drive.

 **NOTE:** For some products, you might have to download the software to a USB flash drive by using the product name or number.

1. Go to <http://www.hp.com/support>.
2. Enter the product name or number, select your computer, and then select your operating system.
3. In the **Diagnostics** section, follow the on-screen instructions to select and download the specific UEFI Diagnostics version for your computer.

Using Remote HP PC Hardware Diagnostics UEFI settings (select products only)

Remote HP PC Hardware Diagnostics UEFI is a firmware (BIOS) feature that downloads HP PC Hardware Diagnostics UEFI to your computer. It can then run the diagnostics on your computer, and it might upload results to a preconfigured server.

For more information about Remote HP PC Hardware Diagnostics UEFI, go to <http://www.hp.com/go/techcenter/pcdiags>, select **Diagnose Other Potential Issues**, scroll down to **Remote PC Hardware Diagnostics UEFI**, and then select **Learn More**.

Downloading Remote HP PC Hardware Diagnostics UEFI

Remote HP PC Hardware Diagnostics UEFI is also available as a SoftPak that you can download to a server.

Downloading the latest Remote HP PC Hardware Diagnostics UEFI version

You can download the latest Remote HP PC Hardware Diagnostics UEFI version to a USB flash drive.

1. Go to <http://www.hp.com/go/techcenter/pcdiags>. The HP PC Diagnostics home page is displayed.

2. Select **Diagnose PC Hardware Issues outside of the OS**, scroll down to the expanded window that appears, and then select **Download**.
3. A pop-up that asks what you want to do with the file opens. Select **Open** or **Save As**. The latest version of the diagnostics tool opens or downloads to the selected location.

Downloading Remote HP PC Hardware Diagnostics UEFI by product name or number

You can download Remote HP PC Hardware Diagnostics UEFI by product name or number.



NOTE: For some products, you might have to download the software by using the product name or number.

1. Go to <http://www.hp.com/support>.
2. Select **Software and Drivers**, select your type of product, enter the product name or number in the search box that is displayed, select your computer, and then select your operating system.
3. In the **Diagnostics** section, follow the on-screen instructions to select and download the **Remote UEFI** version for the product.

Customizing Remote HP PC Hardware Diagnostics UEFI settings

Using the Remote HP PC Hardware Diagnostics setting in Computer Setup (BIOS), you can perform several customizations.

- Set a schedule for running diagnostics unattended. You can also start diagnostics immediately in interactive mode by selecting **Execute Remote HP PC Hardware Diagnostics UEFI**.
- Set the location for downloading the diagnostic tools. This feature provides access to the tools from the HP website or from a server that has been preconfigured for use. Your computer does not require the traditional local storage, such as a hard drive or USB flash drive, to run remote diagnostics.
- Set a location for storing the test results. You can also set the user name and password that you use for uploads.
- Display status information about the diagnostics run previously.

To customize Remote HP PC Hardware Diagnostics UEFI settings, follow these steps:

1. Turn on or restart the computer, and when the HP logo appears, press **f10** to enter Computer Setup.
2. Select **Advanced**, and then select **Settings**.
3. Make your customization selections.
4. Select **Main**, then select **Save Changes and Exit** to save your settings.

Your changes take effect when the computer restarts.

13 Specifications

This chapter provides specifications for your computer system.

Computer specifications

This section provides specifications for your computer. When you travel with your computer, the computer dimensions and weights, as well as input power ratings and operating specifications, provide helpful information.

Table 13-1 Computer specifications

	Metric	U.S.
Dimensions		
Width	355 mm	13.97 in
Depth	245 mm	9.64 in
Height (front to back)	14.55 to 16.99 mm	0.57 to 0.67 in
Weight		
	1.7 kg	3.73 lb
Input power		
Operating voltage and current	19.5 V DC @ 2.31 A - 45 W	
	19.5 V DC @ 3.33 A - 65 W	
	19.5 V DC @ 4.62 A - 90 W	
	19.5 V DC @ 7.70 A - 150 W	
	19.5 V DC @ 10.3 A - 200 W	
Temperature		
Operating	5°C to 35°C	41°F to 95°F
Nonoperating	-20°C to 60°C	-4°F to 140°F
Relative humidity (noncondensing)		
Operating	10% to 90%	
Nonoperating	5% to 95%	
Maximum altitude (unpressurized)		
Operating	-15 m to 3,048 m	-50 ft to 10,000 ft
Nonoperating	-15 m to 12,192 m	-50 ft to 40,000 ft



NOTE: Applicable product safety standards specify thermal limits for plastic surfaces. The device operates well within this range of temperatures.

Display specifications

This section provides specifications for your display.

Table 13-2 Display specifications

	Metric	U.S.
Active diagonal size	40.6 cm	16.0 in
Resolution	2880 × 1800	
	1920 × 1200	
Surface treatment	Brightview (OLED panel)	
Brightness	1000 nits	
	500 nits	
	300 nits	
Viewing angle	WUXGA	
Backlight	OLED	
Display panel interface	eDP 1.5	
	eDP 1.2	

Solid-state drive specifications

This section provides specifications for your SSDs.

Table 13-3 SSD specifications

	512 GB*	1 TB*
Dimensions		
Height	1.0 mm	1.0 mm
Length	50.8 mm	50.8 mm
Width	28.9 mm	28.9 mm
Weight	< 10 g	< 10 g
Interface type		
Ready time, maximum (to not busy)	< 1.0 ms	< 1.0 ms
Access times, logical	0.1 ms	0.1 ms
Transfer rate		
Sequential read	up to 2150 MBps	up to 2150 MBps
Random read	Up to 300,000 IOPs	Up to 300,000 IOPs
Sequential write	up to 1550 MBps	up to 1550 MBps
Random write	Up to 100,000 IOPs	Up to 100,000 IOPs
Total logical sectors	1,000,215,216	1,500,336,388

Table 13-3 SSD specifications (continued)

	512 GB*	1 TB*
Operating temperature	0°C to 70°C (32°F to 158°F)	0°C to 70°C (32°F to 158°F)

* Actual accessible capacity is less. Actual drive specifications might differ slightly.



NOTE: Certain restrictions and exclusions apply. Contact support for details.

14 Power cord set requirements

This chapter provides power cord requirements for countries and regions.

The wide-range input feature of the computer permits it to operate from any line voltage from 100 V AC to 120 V AC, or from 220 V AC to 240 V AC.

The 3-conductor power cord set included with the computer meets the requirements for use in the country or region where the equipment is purchased.

Power cord sets for use in other countries or regions must meet the requirements of the country and region where the computer is used.

Requirements for all countries

These power cord requirements are applicable to all countries and regions.

- The length of the power cord set must be at least **1.0 m** (3.3 ft) and no more than **2.0 m** (6.5 ft).
- All power cord sets must be approved by an acceptable accredited agency responsible for evaluation in the country or region where the power cord set will be used.
- The power cord sets must have a minimum current capacity of 10 A and a nominal voltage rating of 125 V AC or 250 V AC, as required by the power system of each country or region.
- The appliance coupler must meet the mechanical configuration of an EN 60 320/IEC 320 Standard Sheet C13 connector for mating with the appliance inlet on the back of the computer.

Requirements for specific countries and regions

To determine power cord requirements for specific countries and regions, use this table.

Table 14-1 Power cord requirements for specific countries and regions

Country/region	Accredited agency	Applicable note number
Argentina	IRAM	1
Australia	SAA	1
Austria	OVE	1
Belgium	CEBEC	1
Brazil	ABNT	1
Canada	CSA	2
Chile	IMQ	1
Denmark	DEMKO	1
Finland	FIMKO	1
France	UTE	1

Table 14-1 Power cord requirements for specific countries and regions (continued)

Country/region	Accredited agency	Applicable note number
Germany	VDE	1
India	BIS	1
Israel	SII	1
Italy	IMQ	1
Japan	JIS	3
Netherlands	KEMA	1
New Zealand	SANZ	1
Norway	NEMKO	1
The People's Republic of China	CCC	4
Saudi Arabia	SASO	7
Singapore	PSB	1
South Africa	SABS	1
South Korea	KTL	5
Sweden	SEMKO	1
Switzerland	SEV	1
Taiwan	BSMI	6
Thailand	TISI	1
United Kingdom	ASTA	1
United States	UL	2

1. The flexible cord must be Type HO5VV-F, 3-conductor, 0.75 mm² conductor size. Power cord set fittings (appliance coupler and wall plug) must bear the certification mark of the agency responsible for evaluation in the country or region where it will be used.
2. The flexible cord must be Type SVT/SJT or equivalent, No. 18 AWG, 3-conductor. The wall plug must be a 2-pole grounding type with a NEMA 5-15P (15 A, 125 V AC) or NEMA 6-15P (15 A, 250 V AC) configuration. CSA or C-UL mark. UL file number must be on each element.
3. The appliance coupler, flexible cord, and wall plug must bear a T mark and registration number in accordance with the Japanese Dentori Law. The flexible cord must be Type VCTF, 3-conductor, 0.75 mm² or 1.25 mm² conductor size. The wall plug must be a 2-pole grounding type with a Japanese Industrial Standard C8303 (7 A, 125 V AC) configuration.
4. The flexible cord must be Type RVV, 3-conductor, 0.75 mm² conductor size. Power cord set fittings (appliance coupler and wall plug) must bear the CCC certification mark.
5. The flexible cord must be Type H05VV-F 3-conductor, 0.75 mm² conductor size. KTL logo and individual approval number must be on each element. Approval number and logo must be printed on a flag label.
6. The flexible cord must be Type HVCTF 3-conductor, 1.25 mm² conductor size. Power cord set fittings (appliance coupler, cable, and wall plug) must bear the BSMI certification mark.

7. For 127 V AC, the flexible cord must be Type SVT or SJT 3-conductor, 18 AWG, with plug NEMA 5-15P (15 A, 125 V AC), with UL and CSA or C-UL marks. For 240 V AC, the flexible cord must be Type H05VV-F 3-conductor, 0.75 mm² or 1.00 mm² conductor size, with plug BS 1363/A with BSI or ASTA marks.

15 Swelling or deformation of notebook battery

To protect your hardware from potential damage, HP recommends that if you are experiencing battery swelling, stop using the notebook until you can replace the battery.

You can contact HP to understand what battery replacement options are available. To learn more about lithium-ion batteries and the factors that can accelerate battery swelling, see https://support.hp.com/us-en/document/ish_6824662-6824706-16.

Swollen notebook batteries

You might notice that your notebook battery has become somewhat deformed or swollen over time. In some cases, the battery swelling might be significant enough to impact other components of the system including the touchpad, keyboard, and chassis.

Swollen battery is not a safety issue

A swollen battery does not present a safety issue. It is the result of the generation of gases per the normal degradation of the battery cell over time.

HP has worked closely with our battery cell suppliers and third-party industry experts to help minimize the potential for HP batteries to swell over time and to identify that swollen batteries are not a safety issue.

Discontinue using a swollen battery

To protect your hardware from potential damage, HP recommends that, if you are experiencing battery swelling, you stop using the notebook until the battery can be replaced.

You can contact <https://www.hp.com/go/contacthp> to understand what battery replacement options are available.

Replace a swollen battery

If a battery is under warranty, HP will replace the battery per the terms and conditions of the HP Worldwide Limited Warranty or applicable HP Care Packs.

For batteries no longer under warranty, contact HP to purchase a genuine HP replacement battery.

Minimize battery swelling

Multiple factors can accelerate battery swelling.

To help mitigate battery swelling over time, you can use either HP Adaptive Battery Optimizer (consumer notebooks) or HP Battery Health Manager (commercial notebooks) settings to improve battery longevity and performance for various use scenarios.

Adaptive Battery Optimizer (consumer notebooks)

Adaptive Battery Optimizer technology can help mitigate the factors that cause the battery to swell. It is available on select HP OMEN, HP Spectre, HP Pavilion, and HP ENVY notebook computers.

Adaptive Battery Optimizer has been available on select gaming notebooks since 2019 and select consumer notebooks since 2020. To learn more about enabling Adaptive Battery Optimizer on your HP notebook, see https://support.hp.com/us-en/document/ish_9908083-9908127-16.

HP Battery Health Manager (commercial notebooks)

HP Battery Health Manager provides an easy-to-manage solution to help mitigate factors that cause the battery to swell. It is available on select HP ProBook and HP EliteBook notebook computers.

HP Battery Health Manager is available on select commercial notebooks manufactured since 2016. To learn more about HP Battery Health Manager, see https://support.hp.com/us-en/document/ish_4449597-3519507-16.

16 Recycling

When a nonrechargeable or rechargeable battery has reached the end of its useful life, do not dispose of the battery in general household waste. Follow the local laws and regulations in your area for battery disposal.

HP encourages customers to recycle used electronic hardware, HP original print cartridges, and rechargeable batteries. For more information about recycling programs, see the HP website at <http://www.hp.com/recycle>.

Index

- A**
- AC adapter and battery light, identifying 7
 - AC adapters, spare part numbers 20
 - action key, identifying 13
 - antenna
 - illustrated 20
 - spare part number 20
 - antenna cable
 - removal 55
 - spare part number 55
 - audio-out (headphone)/audio-in (microphone) combo jack, identifying 5
 - audio, product description 2
- B**
- backup, creating 148
 - backups 148
 - battery
 - illustrated 17
 - spare part number 17
 - battery swelling 163
 - BIOS
 - determining version 138, 142
 - downloading an update 139, 140, 143
 - preparing for an update 142
 - starting the Setup Utility 138
 - updating 138, 142
 - Bluetooth label 14
 - boot order
 - changing using the f9 prompt 144
 - boot order, changing 150
 - bottom components 13
 - bottom cover
 - illustrated 17
 - removal 30
 - spare part number 30
 - spare part numbers 17
 - buttons
 - left touchpad 9, 10
 - power 12
 - right touchpad 9, 10
- C**
- camera lights, identifying 8
 - camera module
 - removal 55
 - spare part number 55
 - camera privacy cover
 - identifying 8
 - camera/microphone module
 - illustrated 19
 - spare part number 19
 - cameras
 - identifying 8
 - caps lock light 11
 - caring for your computer 26
 - cautions
 - electrostatic discharge 22, 23
 - cleaning your computer 26
 - caring for wood veneer 28
 - disinfecting 27
 - HP Easy Clean 26
 - removing dirt and debris 26
 - components
 - bottom 13
 - display 7
 - keyboard area 9
 - left side 6
 - lights 10
 - right side 5
 - touchpad 9
 - computer major components 15
 - Computer Setup
 - navigating and selecting 141
 - restoring factory settings 141
 - starting 141
 - computer specifications 157
 - connectors
 - power 6, 7
 - control zone 9
 - creating recovery media 146
- D**
- display
 - specifications 157, 158
 - display assembly
 - subcomponents 18
 - display back cover
 - illustrated 20
 - display cable
 - removal 55
 - spare part number 55
 - display components 7
 - display panel
 - illustrated 19
 - product description 2
 - removal 55
 - spare part number 55
 - spare part numbers 19
 - display panel cable
 - illustrated 20
 - spare part number 20
- E**
- electrostatic discharge (ESD) 22, 23
 - preventing damage 22-24
 - erase and reformat recovery media
 - removal 147
 - esc key, identifying 12
- F**
- factory reset 145
 - fan
 - illustrated 18
 - removal 47
 - spare part number 47
 - spare part numbers 18
 - fn key, identifying 12
- G**
- graphics, product description 1
 - grounding methods 22-24
 - guidelines
 - packaging 22, 28
 - transporting 22, 28
 - workstation 22
- H**
- hard drive
 - product description 2
 - specifications 157
 - HDMI port
 - identifying 6

- heat sink
 - illustrated 18
 - removal 51
 - spare part numbers 18, 51
 - hinge
 - illustrated 20
 - spare part numbers 20
 - hinges
 - removal 55
 - spare part number 55
 - HP PC Hardware Diagnostics UEFI
 - downloading 154
 - failure ID code 153
 - HP Hotkey Support software 154
 - starting 153, 154
 - using 153
 - HP PC Hardware Diagnostics Windows
 - accessing 151, 152
 - downloading 152
 - failure ID code 151
 - installing 153
 - using 151
 - HP Recovery media
 - recovery 149
 - HP Sure Recover 150
- I**
- illustrated parts catalog 15
 - install
 - Chromebook Recovery Utility 146
 - Recovery Utility 146
 - integrated numeric keypad, identifying 13
 - internal microphones, identifying 8
- J**
- jacks
 - audio-out (headphone)/audio-in (microphone) 5
- K**
- keyboard
 - product description 3
 - keyboard with top cover
 - spare part numbers 62
 - keypad, integrated numeric 13
 - keys
 - action 13
 - esc 12
 - fn 12
 - num lock 13
 - Windows 13
- L**
- labels
 - Bluetooth 14
 - regulatory 14
 - serial number 14
 - service 14
 - wireless certification 14
 - WLAN 14
 - left control zone, identifying 9
 - left side components 6
 - lights
 - AC adapter and battery 7
 - caps lock 11
 - microphone mute 11
 - mute 11
 - power 11
 - touchpad 9
 - low blue light mode 7
- M**
- memory module
 - product description 2
 - microphone
 - product description 2
 - microphone mute light, identifying 11
 - model name 1
 - mute light, identifying 11
- N**
- num lock key, identifying 13
- O**
- operating system, product description 4
- P**
- packaging guidelines 22, 28
 - pointing device, product description 3
 - ports
 - HDMI 6
 - product description 3
 - USB port 5, 6
 - USB Type-C power connector and Thunderbolt port with HP Sleep and Charge and DisplayPort output 6, 7
 - power button, identifying 12
 - power connector
 - identifying 6, 7
 - power cord
 - requirements for all countries 160
 - requirements for specific countries and regions 160
 - set requirements 160
 - power cords, spare part numbers 20
 - power light, identifying 11
 - Power management board
 - removal 43
 - spare part number 43
 - power requirements, product description 3
 - primary storage
 - product description 2
 - processor
 - product description 1
 - product description
 - audio 2
 - display panel 2
 - graphics 1
 - hard drive 2
 - keyboard 3
 - memory module 2
 - microphone 2
 - operating system 4
 - pointing device 3
 - ports 3
 - power requirements 3
 - primary storage 2
 - processors 1
 - product name 1
 - security 3
 - serviceability 4
 - solid-state drive 2
 - video 2
 - wireless 2
 - product name 1
 - product name and number, computer 14
- R**
- recovering 145
 - recovering Chrome operating system 146
 - recovery 148
 - discs 149
 - media 149
 - USB flash drive 149
 - recovery media 148

- creating using HP Cloud Recovery Download Tool 148
 - creating using Windows tools 148
- Recovery Utility 146
- regulatory information
 - regulatory label 14
 - wireless certification labels 14
- Remote HP PC Hardware Diagnostics UEFI settings
 - customizing 156
 - using 155
- removal and replacement
 - procedures 30, 41
 - SSD 44
- resetting 145
- restoring 148
- restoring and recovery
 - methods 149
- right control zone, identifying 9
- right side components 5

S

- Screw Kit, spare part number 20
- security, product description 3
- serial number, computer 14
- service labels, locating 14
- serviceability, product
 - description 4
- setting up computer after reset or recovery 147
- setup utility
 - navigating and selecting 141
 - restoring factory settings 141
- solid-state drive
 - illustrated 18
 - product description 2
 - spare part numbers 18
 - specifications 158
- spare part country codes 62
- speaker
 - illustrated 17
 - removal 41
 - spare part number 17, 41
- speakers, identifying 13
- special keys
 - identifying 12
 - using 12
- specifications
 - computer 157
 - display 157, 158
 - hard drive 157
 - solid-state drive 158

- SSD
 - removal and replacement 44
 - static electricity 22, 23
 - support information 28
- Sure Start
 - using 144
- swelling or deformation of notebook battery 163
- system board
 - illustrated 17
 - removal 52
 - spare part numbers 17, 52
- system restore 149
- system restore point,
 - creating 148

T

- touch control board
 - illustrated 20
 - removal 55
 - spare part number 55
 - spare part numbers 20
- touchpad
 - illustrated 17
 - removal 49
 - settings 9
 - spare part numbers 17, 49
- touchpad buttons
 - identifying 9, 10
- touchpad components 9
- touchpad light, identifying 9
- touchpad settings, adjusting 9
- touchpad zone, identifying 9, 10
- TPM settings 144
- transition board
 - removal 42
 - spare part number 42
- transporting guidelines 22, 28
- traveling with the computer 14

U

- USB board
 - illustrated 18
 - removal 48
 - spare part number 48
 - spare part numbers 18
- USB port, identifying 5, 6
- USB Type-C power connector and Thunderbolt port with HP Sleep and Charge and DisplayPort output, identifying 6, 7

V

- vent, identifying 14
- video, product description 2

W

- wake-on-voice 7
- Windows
 - backup 148
 - recovery media 148
 - system restore point 148
- Windows key, identifying 13
- Windows tools, using 148
- wireless antennas, identifying 8
- wireless certification label 14
- wireless, product description 2
- WLAN antenna kit
 - illustrated 20
 - spare part number 20
- WLAN antennas, identifying 8
- WLAN device 14
- WLAN label 14
- WLAN module
 - removal 45
 - spare part numbers 45
- workstation guidelines 22