

JVM3162DJ

GE® 1.6 cu. ft. Over-the-Range Microwave Oven

DIMENSIONS AND INSTALLATION INFORMATION (IN INCHES)

NOTE: Requires 120V grounded outlet. Electrical receptacle must be located in cabinet above microwave oven. No additional wiring, venting or cabinet rebuilding necessary in many cases. Complete detailed, easy-to-follow installation instructions and convenient full-size templates are packed with the microwave oven.

IMPORTANT INFORMATION: When installing the microwave oven over a range, allow minimum of 2" from bottom of microwave oven to top of range backguard to allow for removal of light covers.

VENTILATION OPTIONS: The microwave ovens are designed for adaptation to the following three types of ventilation:

- Outside exhaust (vertical – as shown)
- Outside exhaust (horizontal)
- Recirculating (non-vented ductless – see Filter Kit drawing)

INSTALLATION INFORMATION: This information is not intended to be used for installing unit described. Before installing, consult installation instructions packed with product/kit for current dimensional data.

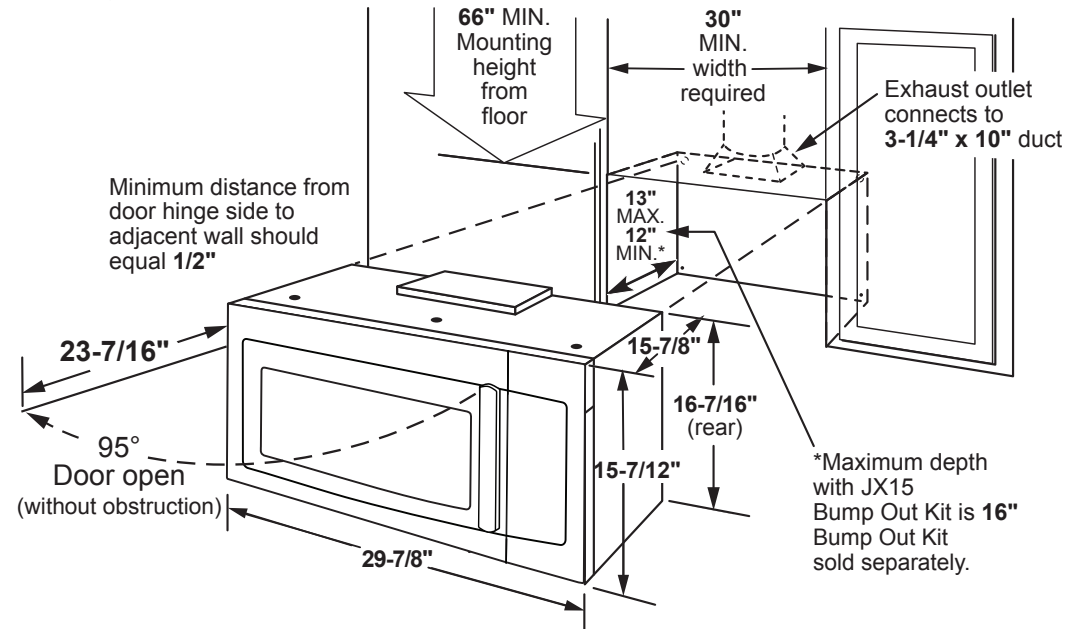

For answers to your Monogram, GE Café™ Series, GE Profile™ Series or GE Appliances product questions, visit our website at geappliances.com or call GE Answer Center® Service, 800.626.2000.



Specification Revised 1/18

JVM3162DJ

GE® 1.6 cu. ft. Over-the-Range Microwave Oven

DIMENSIONS AND INSTALLATION INFORMATION (IN INCHES)

HOOD EXHAUST DUCT: Outside ventilation requires a **HOOD EXHAUST DUCT**. Read the following carefully.

EXHAUST CONNECTION: The hood exhaust has been designed to mate with a standard 3-1/4" x 10" rectangular duct. If a round duct is required, a rectangular-to-round transition adaptor must be used. Do not use less than a 6" diameter duct.

REAR EXHAUST: If a rear or horizontal exhaust is to be used, care should be taken to align exhaust with space between studs, or wall should be prepared at the time it is constructed by leaving enough space between the wall studs to accommodate exhaust.

MAXIMUM DUCT LENGTH: For satisfactory air movement, the total duct length of 3-1/4" x 10" rectangular or 6" diameter round duct should not exceed 120 equivalent feet.

ELBOWS, TRANSITIONS, WALL AND ROOF CAPS, etc., present additional resistance to airflow and are equivalent to a section of straight duct which is longer than their actual physical size. When calculating the total duct length, add the equivalent length of all transitions and adaptors plus the lengths of all straight duct sections. The chart below shows the approximate feet of equivalent length of some typical ducts.

DUCT	EQUIVALENT FEET
A. Rectangular-To-round Transition Adaptor	5 ft.
B. Wall Cap	40 ft.
C. 90° Elbow	10 ft.
D. 45° Elbow	5 ft.
E. 90° Elbow	25 ft.
F. 45° Elbow	5 ft.
G. Roof Cap	24 ft.

OPTIONAL ACCESSORIES (AVAILABLE AT ADDITIONAL COST)

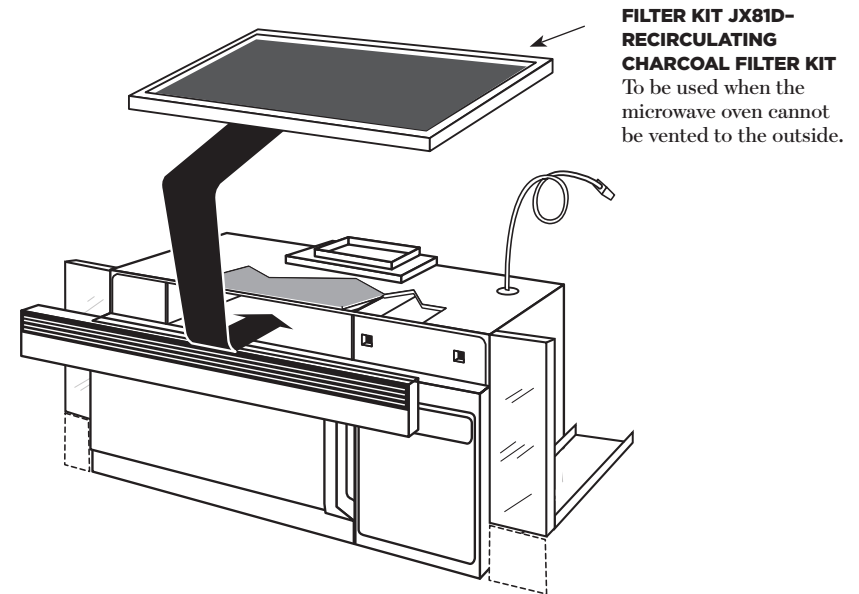

For answers to your Monogram, GE Café™ Series, GE Profile™ Series or GE Appliances product questions, visit our website at geappliances.com or call GE Answer Center® Service, 800.626.2000.



Specification Revised 1/18

JVM3162DJ

GE® 1.6 cu. ft. Over-the-Range Microwave Oven

FEATURES AND BENEFITS

1.6 cu. ft. capacity – 950 Watts (IEC-705 test procedure)

Convenience cooking controls – Operating made quick and easy

Auto and time defrost – Defrosting times and power levels are programmed automatically or manually for optimal results

Turntable on/off – Controls turntable operation

Two-speed, 300-CFM venting system – Removes smoke, steam and odors

10 power levels – Multiple power levels offer cooking flexibility

"Add 30 seconds" button – Add 30 seconds of microwave cooking time

Model JVM3162DJBB – Black

Model JVM3162DJWW – White

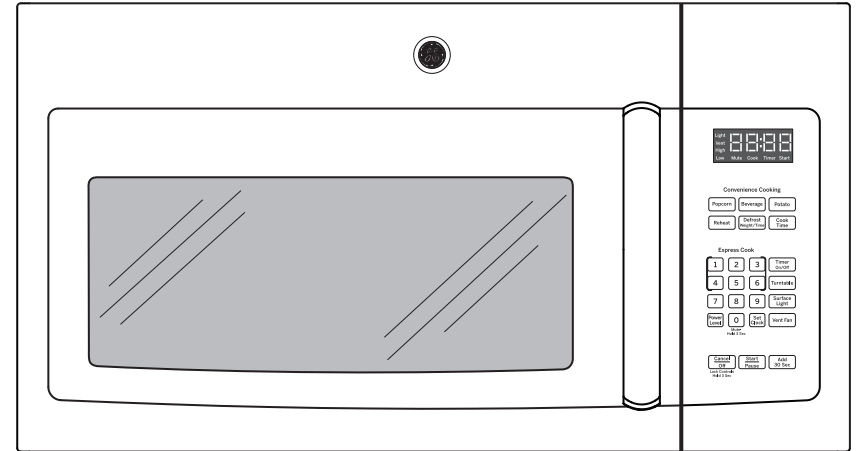

For answers to your Monogram, GE Café™ Series, GE Profile™ Series or GE Appliances product questions, visit our website at geappliances.com or call GE Answer Center® Service, 800.626.2000.



Specification Revised 1/18