

WCOU24LX



Product Family	Wine cooler
Installation	Built-in
Built-In Niche	60 cm
Defrost	Automatic
Cooling type	Fan-assisted
Hinge type	Self-balancing
Hinge position	Left



Wine compartment features



Number of removable shelves	12
Shelves material	Beech
Adjustable shelves	Yes
Removable shelves on telescopic guide rails	Yes
Type of internal light	LED

Functions

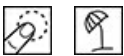

Control setting	Touch controls	Forced light on	Time-limited
Controls	Inside the cooler	Temperature Alarm	Yes
Display type	TFT	Door open alarm	Yes
Display functions	Holiday, Showroom mode, Sabbath mode, Temperature indication	Humidity level setting	Yes
Power-on indicator	Yes		

Technical Features

Adjustable temperature zones	2	Number of compressors	1
Independent cooling systems	2	Compressor type	Standard
Number of door glasses	3	Refrigerant gas type	R600a
Temperature range	40-65°F	Refrigerant quantity	2.7 oz
		Metal back panel	Metal

Temperature setting type	Electronic	Adjustable feet	Yes
Anti-UV door glass	Yes	Door opening type	With handle
Antibacterial Gasket	Yes		

Performance / Energy Label



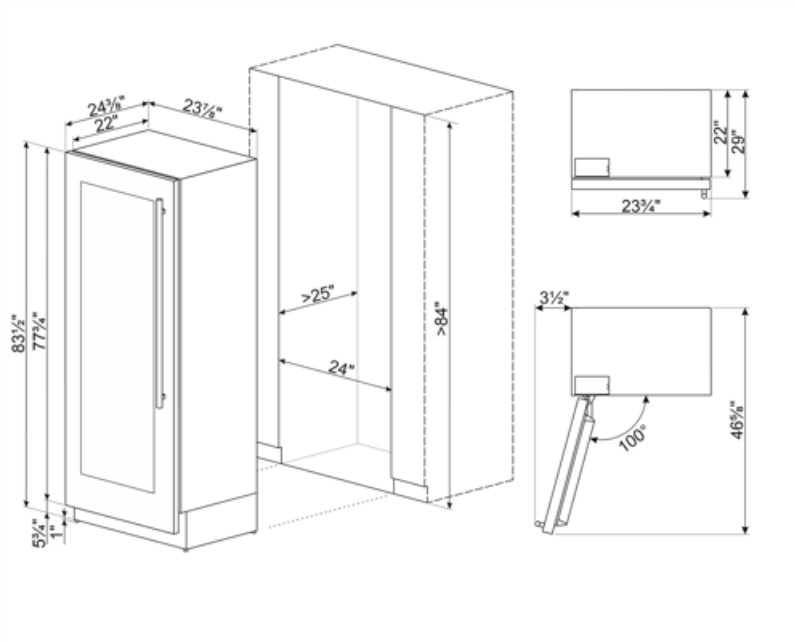

Total net volume	93.0 gal
------------------	----------

Electrical Connection

Current	2,5 A	Power cord length	78 3/4 "
Voltage (V)	115 V	Plug	(B) NEMA 5-15P
Frequency (Hz)	60 Hz		



Symbols glossary

- | | | | |
|--|---|---|--|
|  | The automatic defrost system works by automatically defrosting at regular intervals eliminating the need to defrost altogether. |  | Ventilated: Forced distribution of cold air in the refrigerator compartment, which allows even temperature distribution within the fridge. |
|  | Power saving mode: The power saving mode allows you to disable the refrigerator and keep the freezer working. |  | LED interior lighting: is a more energy efficient and long lasting way of illuminating the interior of the appliance. |
|  | Touch controls: Easy to use touch controls allow the appliance to be programmed at the touch of a button. | | |