



CONVECTION MICROWAVE HOOD

Viking 5 Series – VMOR

PROFESSIONAL FEATURES

- Instant sensor settings for cooking, reheating foods, and popping popcorn
- Four convection settings: ConvecBroil, ConvecRoast, ConvecBake, and a manual convection setting option
- Low Mix Bake and High Mix Roast settings offer use of convection heat to seal and brown outside of foods while using microwave energy to ensure the interior is cooked
- Add-A-Minute allows a minute of extra cooking time to be added with the touch of a button
- Child Lock safety feature locks the control panel to prevent unwanted operation
- Built-in exhaust system
 - 300 CFM
 - Unit shipped assembled to recirculate; may also be vented out the rear or vertically



SPACIOUS OVEN CAVITY

- 1.1 cubic ft. (31.2 liters) oven capacity
 - 17-1/8"W. x 8-1/16"H. x 13-13/16"D.
- 13" (33.0 cm) diameter turntable
- Interior light

INSTALLATION OPTION

- For use with 30"W. Viking cooking products

MODEL NUMBER

- VMOR506SS – 30" Wide Convection Microwave Hood

ACCESSORY

- CFOR1 – Replacement Charcoal Filter

COLOR FINISHES

- Available in Stainless Steel (SS)

WARRANTY

- 2-year full – complete product
- 90-day full – cosmetic parts such as glass, painted items and decorative items
- 5-year limited – magnetron tube



CONVECTION MICROWAVE HOOD

Viking 5 Series – VMOR

30" W. MICROWAVE HOOD	
DESCRIPTION	VMOR506
Overall Width	29-15/16" (76.1 cm)
Overall Height	16-3/8" (41.7 cm)
Overall Depth	15-5/16" (38.9 cm)
Electrical Requirements	120VAC/60Hz, single phase, AC only
Maximum Amp Usage	1.6 kW, 13.2 amps
Oven Interior Dimensions	Width – 17-1/8" (43.5 cm) Height – 8-1/16" (20.5 cm) Depth – 13-13/16" (35.1 cm) Overall Size – 1.1 cu. ft.
Approximate Shipping Weight	85 lb. (38.6 kg)

Please do not prepare installation from brochure data only. See installation instructions for important clearance/installation information.

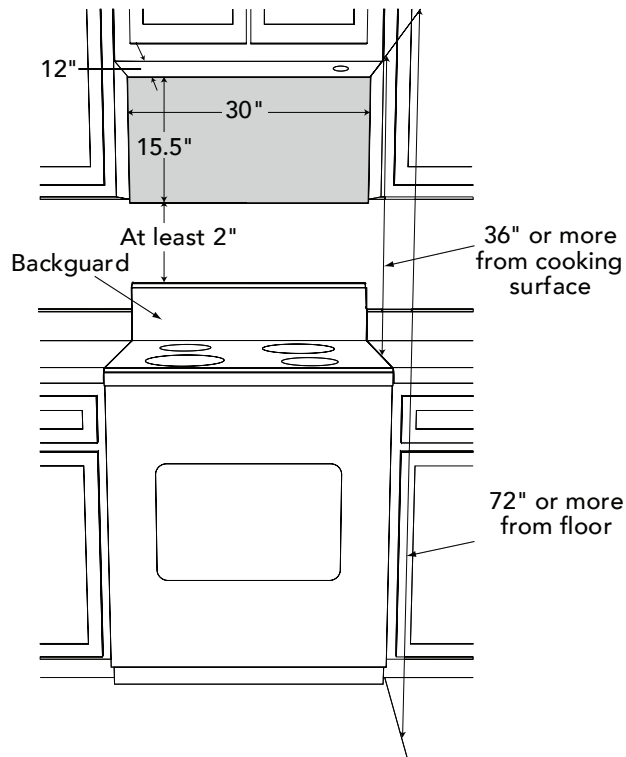

VIKING RANGE, LLC 111 FRONT STREET GREENWOOD, MISSISSIPPI 38930 USA

For detailed product information, model numbers, or to request a quote call 1-888-845-4641 or visit vikingrange.com

© 2018 Viking Range, LLC All rights reserved. Specifications subject to change without notice.