

Product Dimensions

Knob Control Electric Cooktop

KM5621

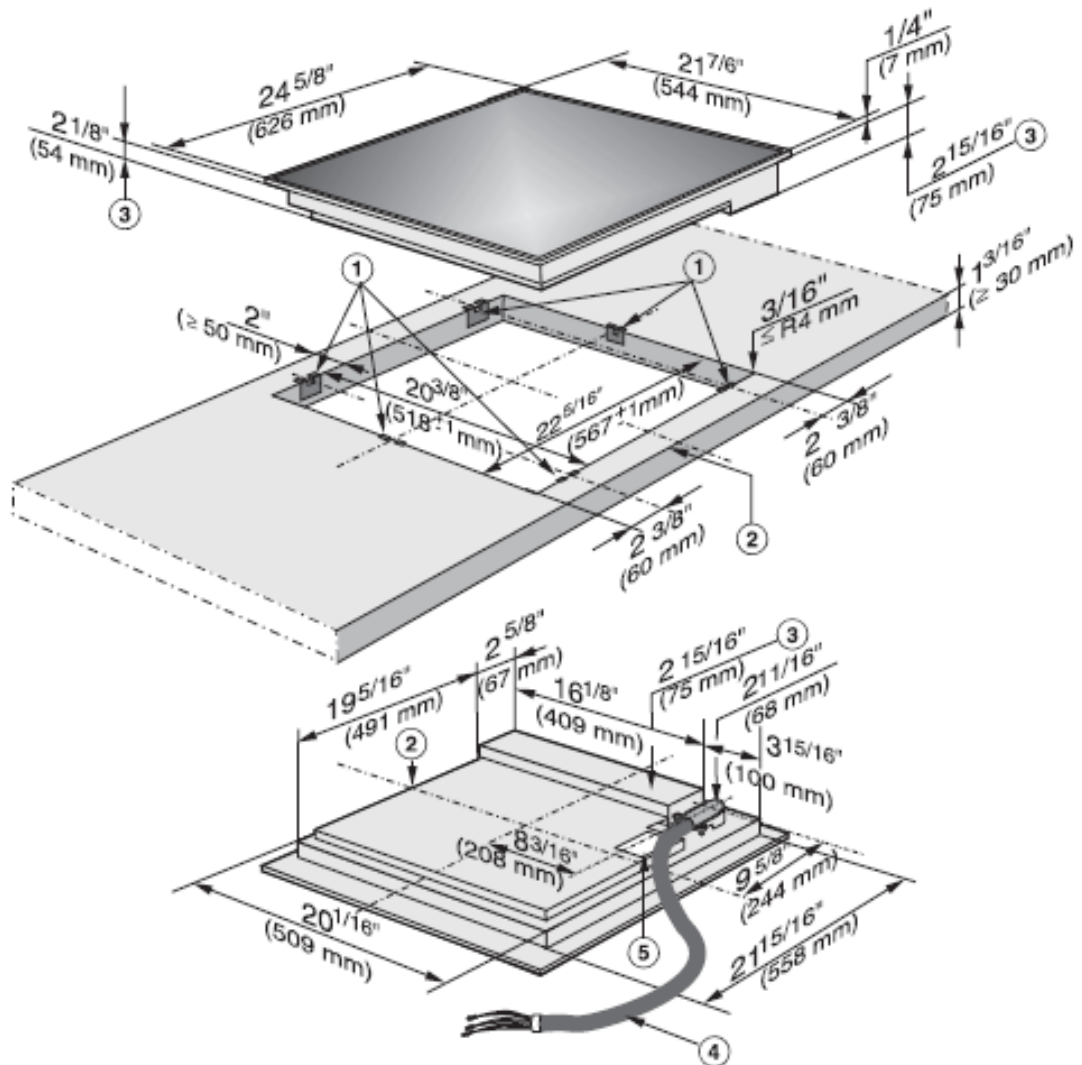

- ① Spring clips
- ② Front
- ③ Installation height
- ④ Power cord, L = $56\frac{11}{16}''$ (1440 mm)
- ⑤ Rating label

Location Codes
E - 208 / 240 Volt - 40 Amp 3-wire power supply connects rear center bottom.
Notes
<ul style="list-style-type: none"> • Please specify 208 Volt or 240 Volt unit when ordering. • All installations must be done in accordance with local codes.

Note: Drawing is not to scale

Specification Sheets OJS 04112011