

## FEATURES

- Dual-stacked sealed surface burners with flame recognition and automatic reignition for safety and ease of use.
- Heavy-duty stainless steel exterior with island trim.
- Individual spark ignition system—only the burner in use will spark.
- Porcelain-coated, cast iron continuous burner grates.
- Signature red control knobs with infinite control.
- Top configurations include infrared charbroiler, infrared griddle and French top with stainless steel covers.

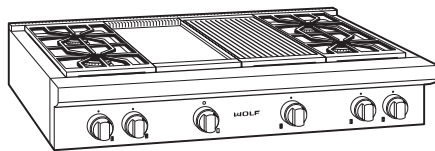

Model SRT484CG



## MODEL OPTIONS

### SIX BURNERS

Charbroiler	SRT486C
Griddle	SRT486G

### FOUR BURNERS

Charbroiler / Griddle	SRT484CG
Double Griddle	SRT484DG
French Top	SRT484F

*LP gas models, add (-LP).*

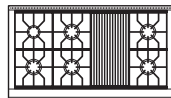

SRT486C

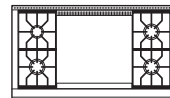

SRT484DG

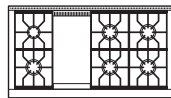

SRT486G

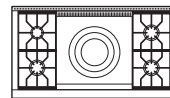

SRT484F

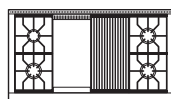

SRT484CG

## ACCESSORIES

- 5" and 10" stainless steel risers, and 20" riser with shelf.
- Signature red, black or stainless steel control knobs.
- Stainless steel, brass or chrome bezels.
- Cast iron S-grates and wok grate.
- Single or double hardwood cutting board (griddle models).
- Griddle cleaning kit (griddle models).
- LP gas high altitude conversion kit.

Accessories available through an authorized Wolf dealer. For local dealer information, visit the find a showroom section of our website, [wolfappliance.com](http://wolfappliance.com).

## SPECIFICATIONS

PRODUCT	
Dimensions	47 <sup>7</sup> / <sub>8</sub> "W x 8 <sup>1</sup> / <sub>2</sub> "H x 28 <sup>1</sup> / <sub>2</sub> "D
Weight	240–280 lb
ELECTRICAL	
Supply	110/120 VAC, 60 Hz
Service	15 amp circuit
GAS	
Supply	<sup>3</sup> / <sub>4</sub> " rigid pipe
Inlet	<sup>1</sup> / <sub>2</sub> " NPT female

## BURNER RATING (Btu)

SURFACE	SIMMER		HIGH
	Large (5 or 3)	950	
Small	325	9,200	
FEATURE	NATURAL		LP
	Charbroiler	16,000	
Griddle	15,000	13,000	
Double Griddle	30,000	26,000	
French Top	15,000	15,000	

Specifications are subject to change without notice. Visit [wolfappliance.com/specs](http://wolfappliance.com/specs) for the most up-to-date information.

Dimensions may vary  $\pm 1/8"$  (3). Dimensions in parentheses are millimeters unless otherwise specified.

## DIMENSIONS

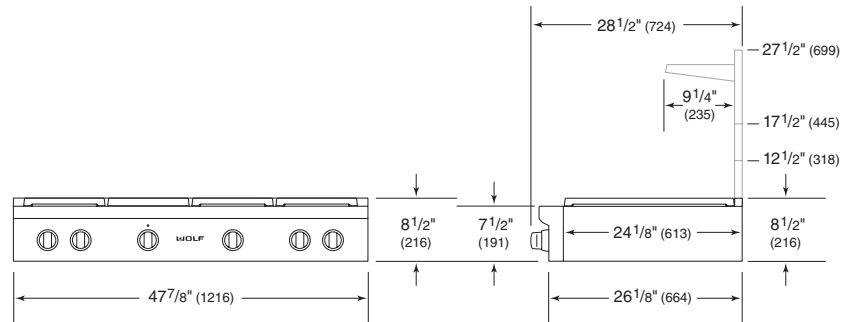

## INSTALLATION

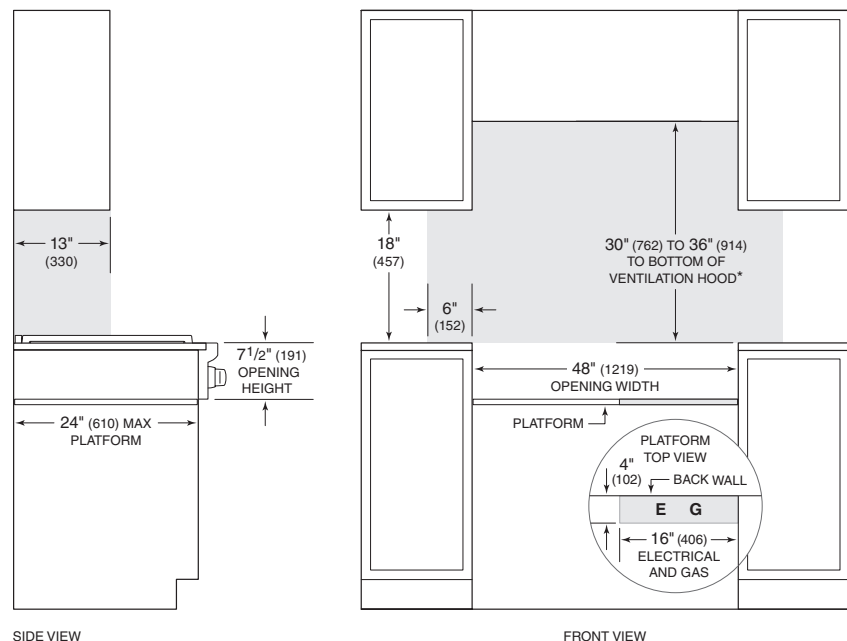

\*Without ventilation hood, 36" (914) minimum clearance countertop to combustible materials, 44" (118) for charbroiler.  
 NOTE: Shaded area above countertop indicates minimum clearance to combustible surfaces, combustible materials cannot be located within this area.  
 Electrical and gas supply located through bottom of platform.  
 A riser is required for installations against a combustible surface.