

10473





### **Get excited about our new packaging!**

We're switching from plastic to paper-based packaging. That's why you might find a mix of paper and plastic in our boxes!

### **Nos nouveaux emballages vous emballeront !**

Nous passons des emballages en plastique aux emballages à base de papier. C'est pourquoi vous pourriez trouver un mélange de papier et de plastique dans nos boîtes !

### **¡Te presentamos nuestros nuevos empaques!**

Estamos sustituyendo las bolsas de plástico por bolsas con base de papel. ¡Por eso, puedes encontrar una mezcla de papel y de plástico en nuestras cajas!

**[LEGO.com/sustainable-packaging](https://www.lego.com/sustainable-packaging)**



Rebuild  
the  
world™



## Building the Big Skills Toddlers Need

We believe in big starts. Our big bricks are designed for little hands to master. When toddlers' creativity is set free, their opportunities to learn become endless. We call it Learning Through Play. And it inspires every LEGO® DUPLO® set. Based on thorough scientific research, each set helps young minds develop both IQ skills (cognitive, physical, creative) and EQ skills (social, emotional). Let all toddlers Start Off Big. LEGO DUPLO sets are categorized into benefit territories that match toddlers' ages and developmental stages.

## Développer les grandes compétences dont les tout-petits ont besoin

Nous croyons aux grands départs. Nos grandes briques sont conçues pour être manipulées par les petites mains. Lorsque la créativité des tout-petits est libérée, les possibilités d'apprentissage deviennent infinies. C'est ce que nous appelons apprendre par le jeu. Et c'est ce qui inspire chaque ensemble LEGO® DUPLO®. Basé sur des recherches scientifiques approfondies, chaque ensemble aide les jeunes esprits à développer à la fois les compétences QI (cognitives, physiques, créatives) et les compétences QE (sociales, émotionnelles). Permettez à tous les enfants en bas âge de commencer en beauté.

Les ensembles LEGO DUPLO sont classés en catégories d'avantages qui correspondent à l'âge et au stade de développement des tout-petits.

## Desarrollamos las grandes habilidades que necesitan los peques

Creemos en los grandes comienzos. Nuestros bricks más grandes están diseñados para que una manita pueda manejarlos con facilidad. Cuando la creatividad de los peques fluye libremente, las oportunidades de aprender se vuelven infinitas. A eso lo llamamos "aprendizaje mediante el juego". Y es la fuente que inspira cada set LEGO® DUPLO®. Basados en rigurosos estudios científicos, estos sets contribuyen al desarrollo del cociente intelectual (CI, resultante de las habilidades cognitivas, físicas y creativas) y el cociente emocional (CE, que depende de las habilidades sociales y emocionales) de las mentes más jóvenes. Todos los niños y niñas merecen un gran comienzo.

Los sets LEGO DUPLO se clasifican en campos de aprovechamiento acordes con las edades y etapas de desarrollo de los niños y niñas.



LOGICAL  
THINKING



EXPRESSING  
YOURSELF

LEGO® DUPLO® sets in this territory can help toddlers master a range of skills, including how to care for others and understand feelings, learn to compare, match and sort things, and play out familiar situations. When you play along and offer instructions and guidance, you create a safe, creative space that encourages toddlers to learn.



PLAY  
IDEAS

IDÉES  
DE JEUX

IDEAS  
DE JUEGO

PENSÉE  
LOGIQUE



EXPRESSION  
DE SOI

Les ensembles LEGO® DUPLO® de cette catégorie peuvent aider les tout-petits à maîtriser toute une série de compétences, notamment à se soucier des autres et à comprendre les sentiments, à apprendre à comparer, à assortir et à trier des objets, et à simuler des situations familiales. Lorsque vous jouez le jeu et que vous donnez des instructions et des conseils, vous créez un espace sûr et créatif qui encourage les tout-petits à apprendre.

PENSAMIENTO  
LÓGICO



EXPRESATE

Los sets LEGO® DUPLO® de este campo ayudan a los peques a dominar una amplia variedad de habilidades: cuidar de los demás y comprender los sentimientos, aprender a comparar, emparejar y clasificar cosas, interpretar situaciones familiares, etc. Al jugar con instrucciones y orientación, se crea un espacio seguro y creativo que invita a los niños y niñas a aprender.









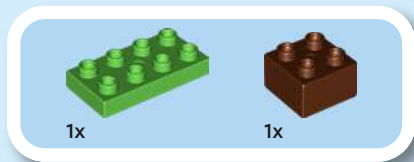

1

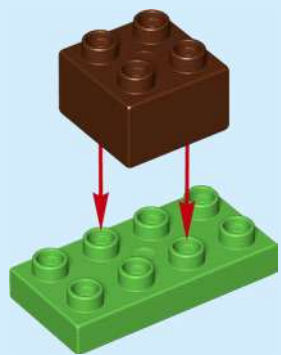

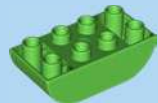

1x

2

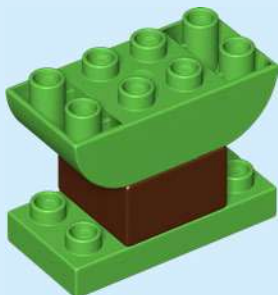

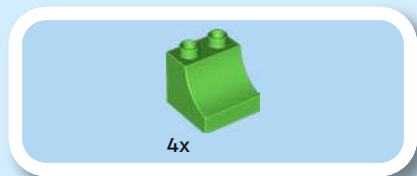

3

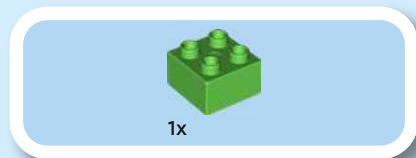
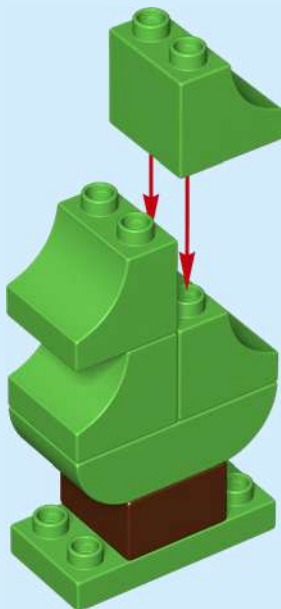

4





1x

1

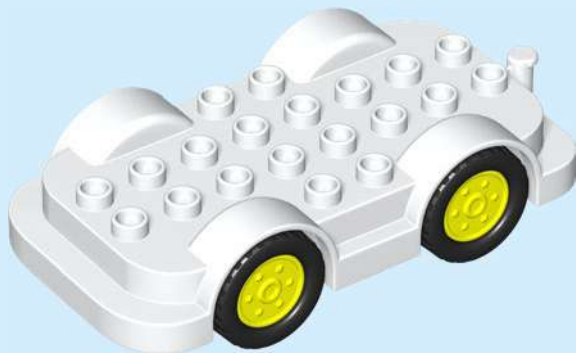

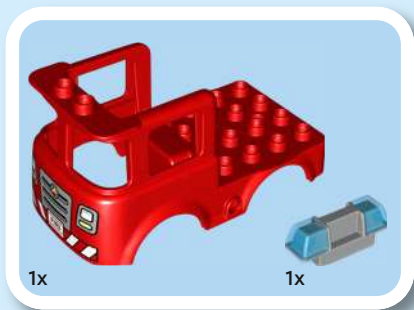

2





3



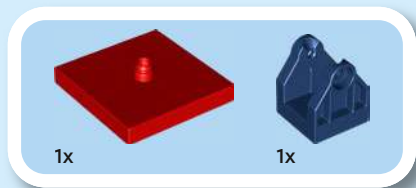

4

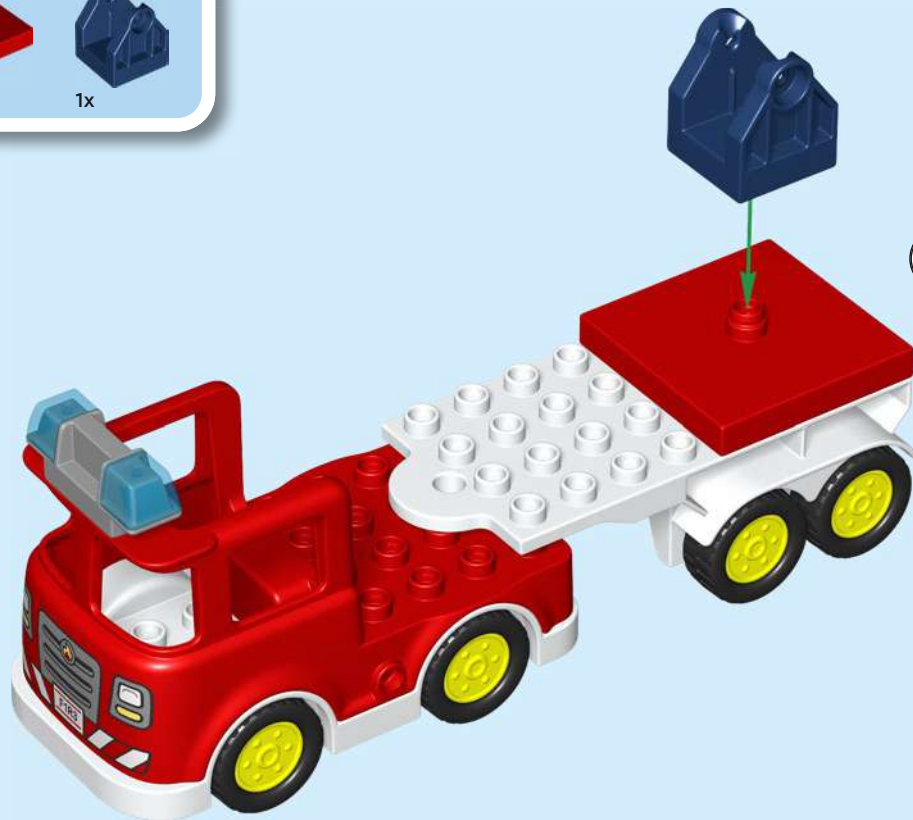

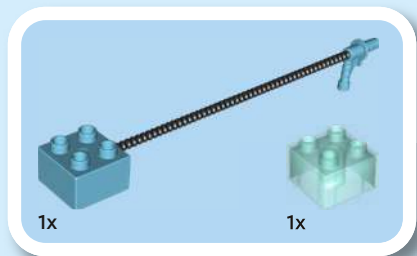

5

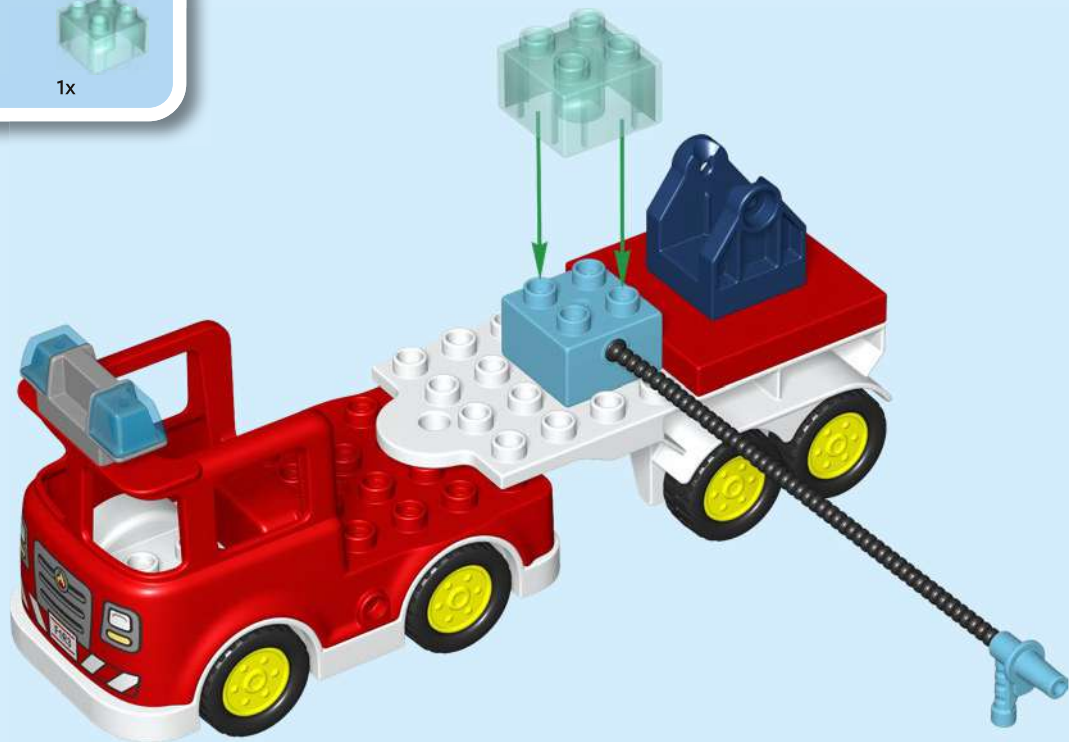

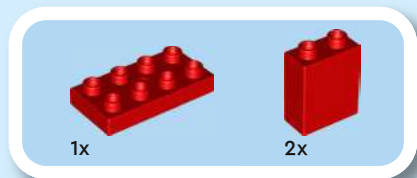

6

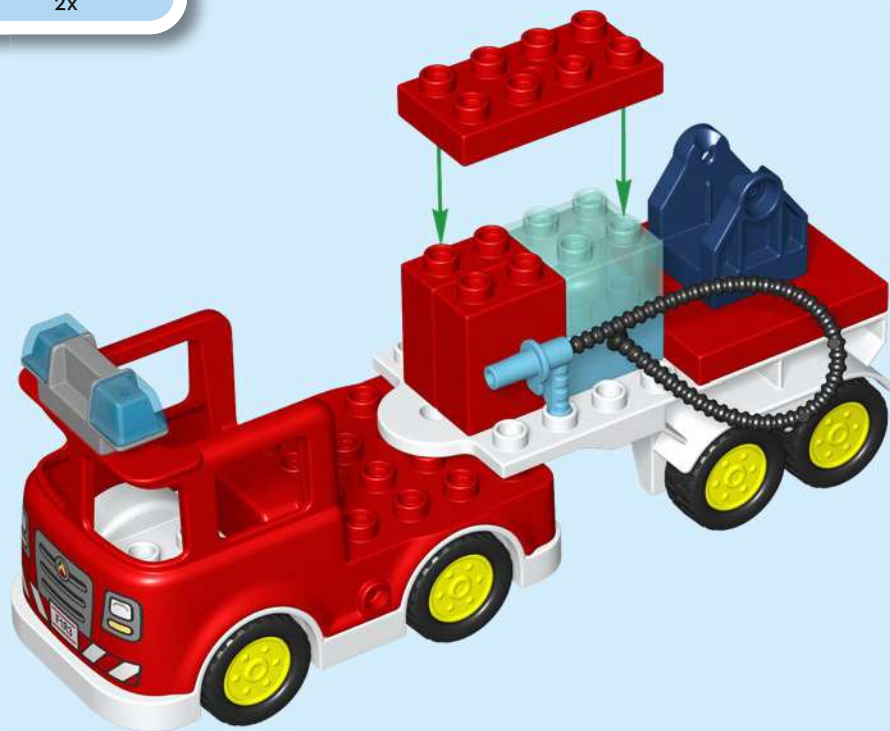

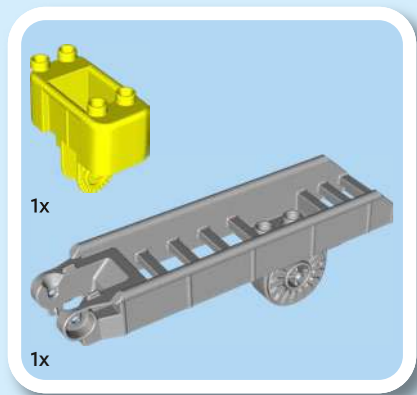

7

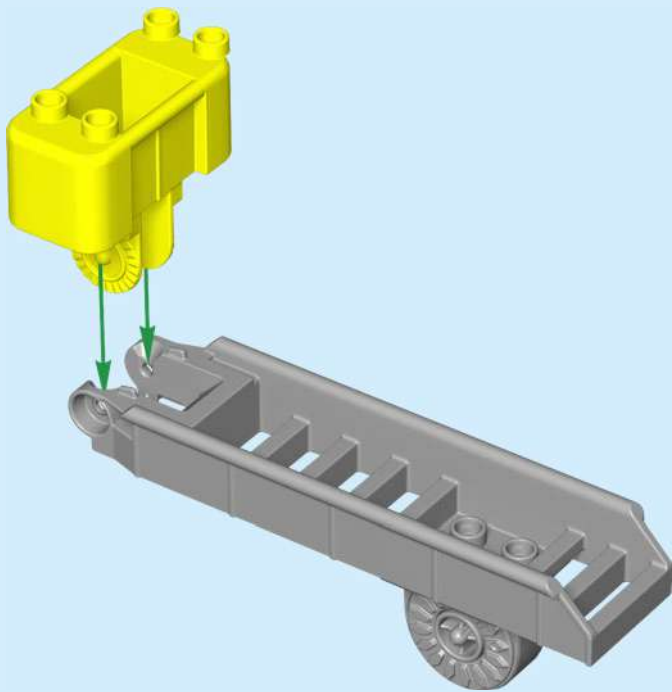

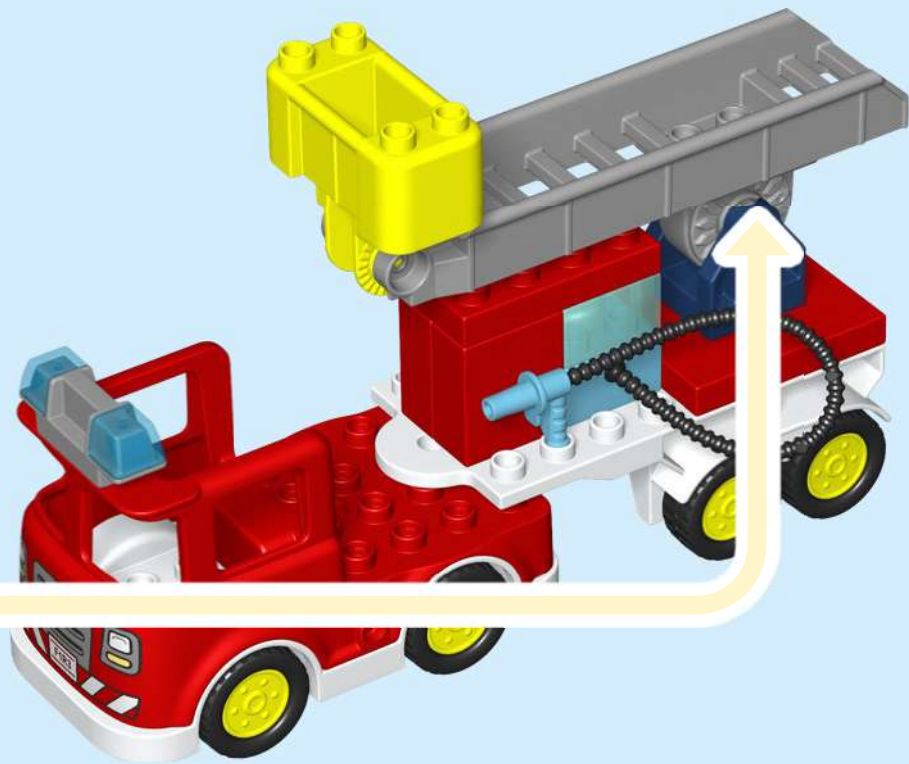



EXPLORE  
**LEGO® DUPLO®**  
DIGITAL GAMES

DES JEUX NUMÉRIQUES  
**LEGO® DUPLO®**  
À DÉCOUVRIR

EXPLORA LOS  
JUEGOS DIGITALES  
**LEGO® DUPLO®**



Apple and the Apple logo are trademarks of Apple Inc., registered in the U.S. and other countries and regions. App Store is a service mark of Apple Inc. Google Play and the Google Play logo are trademarks of Google LLC. Tencent and the Tencent logo are trademarks of Tencent Inc.





10473



10954



10913



10474



10477



10475



1x  
6589646



1x  
6587447



2x  
6270047



1x  
6464779



1x  
6217422



1x  
6375443



1x  
6584343



1x  
6507900



1x  
6481109



1x  
6368269



1x  
6370543



1x  
6375441



4x  
6094052



2x  
6040230

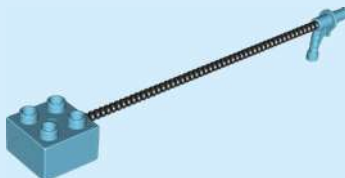

1x  
6563752



1x  
6390099



1x  
4168579



1x  
4153497

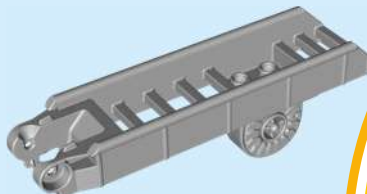

1x  
6364301



1x  
6587446

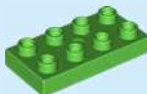

1x  
4170795

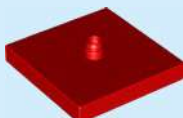

1x  
4603681

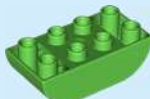

1x  
4652748



 [LEGO.com/service](https://www.LEGO.com/service)

YOU COULD  
**WIN!**



Scan this QR code or go to  
**LEGO.COM/PRODUCTFEEDBACK** and give us  
your short feedback about this LEGO® set  
for a chance to win a cool LEGO prize.

Terms and Conditions apply\*



**EN: YOU COULD WIN.** Terms and Conditions apply\* **DE: Du könntest GEWINNEN.** Es gelten die Teilnahmebedingungen\* **FR: Tu pourrais GAGNER.** Des conditions s'appliquent\* **IT: Potresti VINCERE tu.** Termini e condizioni sono applicabili\* **ES: Puedes GANAR.** Aplican términos y condiciones\* **PT: PODERÁ GANHAR.** Aplicam-se Termos e Condições\* **ZH: 轻松获奖.** 条款和条件适用\* **PL: Szansa na WYGRANĄ.** Obowiązuje regulamin\* **CS: Máte šanci VYHRÁT.** Platí všeobecné smluvní podmínky\* **SK: Máte šancu VYHRAŤ.** Platia všeobecné zmluvné podmienky\* **HU: TE IS NYERHETSZ.** Felhasználási feltételek érvényesek\* **UA: ВИ МОЖЕТЕ ВИГРАТИ.** Застосовуються загальні положення та умови\* **RO: Ai putea CÂȘTIGA.** Se aplică termeni și condiții\* **BG: Можете да СПЕЧЕЛИТЕ.** Има определени правила и условия\* **LV: Tu vari LAIMĒT.** Ir spēkā noteikumi un nosacījumi.\* **ET: Sul on võimalus VÕITA.** Kehtivad tingimused\* **LT: Jūs galite LAIMĖTI.** Taikomos sąlygos\*

\*[LEGO.com/productfeedback-terms](https://www.lego.com/productfeedback/terms)

