



Contents

About this manual

Safety information

General requirements

Emergency measures

Disposal and recycling

Operating environment

Product overview

Appearance

Display screen

Specifications

Get started with your power station

Power on/off

Power your appliances

Charge your power station

Manage your power station

Use EcoFlow app

Use EcoFlow PowerInsight

Explore your power station

Maximize power output

Maintain uninterrupted power

Store and maintain your power station

Storage

Cleaning

Maintenance

Regulatory compliance

About this manual

- This manual introduces detailed instructions on operation, management, and maintenance of DELTA 3 Ultra portable power station.
- Documentation content is subject to change (updates, revisions, or termination) without notice. To get the latest documentation, go to [EcoFlow Support website](#).
- The availability of certain accessories and features described in this manual might vary depending on your country or region.
- Illustrations in this documentation are based on US version and just for demonstrative purpose only.

Please read the product documentation thoroughly and ensure you understand it before using the product. Improper use may cause serious injury, product damage, or property loss. Always refer to the most up-to-date documentation available at <https://www.ecoflow.com/support/download/>. This documentation takes precedence over all other versions.

By using this product, you acknowledge and agree to all terms and conditions stated in the documentation. EcoFlow is not liable for losses caused by improper use or failure to adhere to the provided instructions. Subject to applicable laws and regulations, EcoFlow reserves the right to the final interpretation of this document and all documents related to the product.

Safety information

General requirements

1. Follow the environment temperature requirements specified in this documentation to use or store the product. Avoid degradation or damage to the product, or risks to personal safety due to excessively high or low

- temperatures.
2. Place the product on a stable and flat surface. Avoid damage to the device or personal injury due to the product falling or tipping over.
 3. Keep the product out of reach of children and pets. If the product is to be used near children, they should be closely supervised.
 4. Keep the product away from fumes, smoke, steam, and dust.
 5. Store the product in a tidy, dry, and well-ventilated place.
 6. Ensure that the cable length for each DC connection to this product is less than 3 meters.
 7. Use a soft, dry cloth to wipe and clean the product.
 8. Always disconnect the product from all external power sources before attempting any service or maintenance.
 9. To reduce risk of damage to the electric plug and cord, pull the plug rather than the cord when disconnecting the product.
 10. Electrical appliances connected to this product must comply with local certification requirements, and Type-C ports are only permitted for appliances with fireproof enclosures.
 11. The plug of the charging cable included in the package is a disconnecting device, and the wall outlet to which it is connected must be easily accessible and well grounded.
 12. Grounding Instructions: This product must be grounded. If there is a malfunction or breakdown, grounding provides a path of least resistance to electric current to reduce the risk of electric shock. For your safety, EcoFlow provides a cord with an equipment grounding conductor and a grounding plug. The plug must be plugged into an outlet that is properly installed and grounded in accordance with all local codes and ordinances. **WARNING** – Improper connection of the equipment grounding conductor can result in a risk of electric shock. If you encounter the following situations, consult a qualified electrician instead of modifying the plug provided with the product:
 - You are unsure whether the product is properly grounded;
 - You find that the plug provided with the product does not fit the outlet.
 13. Do not use the product near a heat source, such as a fire source or a heating furnace.
 14. Do not get the product wet or immerse it in any liquid. When using the product in wet environments like rainy areas or places near water, protect it with a waterproof bag.
 15. Do not use the product in an environment with strong static electricity or magnetic fields.
 16. Do not subject this product to severe impacts, vibrations, or drops.
 17. Do not carry this product onto a plane.
 18. Do not disassemble, repair, or modify this product by yourself. For any maintenance or service, please contact EcoFlow Customer Service.
 19. Do not pierce the product with sharp objects.
 20. Do not put fingers or hands into the product.
 21. Do not insert wires or other metal objects into the product to prevent short circuits.
 22. Do not block or restrict the heat dissipation system of the product during operation.
 23. Do not use any unofficial components or accessories. For any replacements, please contact EcoFlow for further assistance.

24. Do not operate this product with a damaged cord or plug, or a damaged output cable.
25. Do not stack any heavy objects on the product.
26. Risk of Electric Shock: Never use the product to supply power tools to cut or access live parts or live wiring, or materials that may contain live parts or live wiring inside, such as building walls, etc.
27. Use in Repair Facility: During use in a repair facility like a vehicle repair center, workshop, or any other place where repairs are conducted, do not place the product on the floor, or at a height less than 457 mm (18 inches) above the floor.
28. AC Timeout Tip: The AC output port of the power station will automatically turn off if the port is idle for a certain period. When the power station is connected to intermittent loads like refrigerators or air conditioners, this feature may be triggered. To ensure continuous power supply for critical uses, such as storing medicines, vaccines, the perishables, or other valuable items in a refrigerator, set the power station's AC timeout interval to never in the EcoFlow app. Additionally, regularly check the power station's battery level.
29. Medical Equipment Limit: The product is not intended for powering life-sustaining medical equipment, including but not limited to medical-grade ventilators (hospital-grade CPAP: Continuous Positive Airway Pressure) or artificial lungs (ECMO: Extracorporeal Membrane Oxygenation). If you plan to use it for other medical equipment, consult with the equipment's manufacturer first to ensure there are no restrictions on using an external power source with their equipment.
30. Medical Equipment Interference: When in use, power supply products will generate electromagnetic fields, which are likely to affect the normal operation of medical implants or personal medical equipment such as pacemakers, cochlear implants, hearing aids, defibrillators, etc. If these types of medical equipment are being used, please contact the manufacturer to inquire about any restrictions on the use of such equipment. These measures are fundamental to ensure a safe distance between the medical implants (for example, pacemakers, cochlear implants, hearing aids, defibrillators, etc.) and this product while in use.

Emergency measures

1. In case of any emergency, take precautions against electric shock before touching the device, such as wearing insulating gloves.
2. If the product gets wet, stop using it immediately and refrain from further operation or powering it on. Place the product in a secure, waterproof, and well-ventilated area, then contact EcoFlow Customer Service for assistance.
3. If the product falls into water, place it in a secure, waterproof, and well-ventilated area, and keep it away from contact until it is completely dry. The dried product should not be used again and must be properly disposed of according to local laws and regulations.
4. If the product catches fire, we recommend that you use the fire extinguishers in the following order: water or water mist, sand, fire blanket, dry powder, and finally a carbon dioxide fire extinguisher.
5. If the device is overturned and severely damaged, wear insulating gloves to power it off, place it in an open area far from flammable materials and

people, and dispose of it according to local laws and regulations.

Disposal and recycling

1. The device with severe damage, malfunction, or depleted battery should be properly disposed of or recycled.
2. The product contains batteries. Please dispose of the product following local laws and regulations for battery disposal and recycling. Do not dispose of it with household waste to avoid environmental pollution and safety hazards.
3. If possible, ensure that the battery is completely discharged (to 0% capacity) before disposing of the device. If not, do not directly put the battery into the recycling box and contact an authorized battery recycling company for proper handling.

Operating environment

Optimal operating temperature	20°C to 30°C (68°F to 86°F)
Charging temperature	0°C to 45°C (32°F to 113°F)
Discharging temperature	-10°C to 45°C (14°F to 113°F)
Storage temperature	-10°C to 45°C (14°F to 113°F)
Operating humidity	20% to 95%
Maximum operating altitude	≤3000m

Product overview

Appearance

Front view

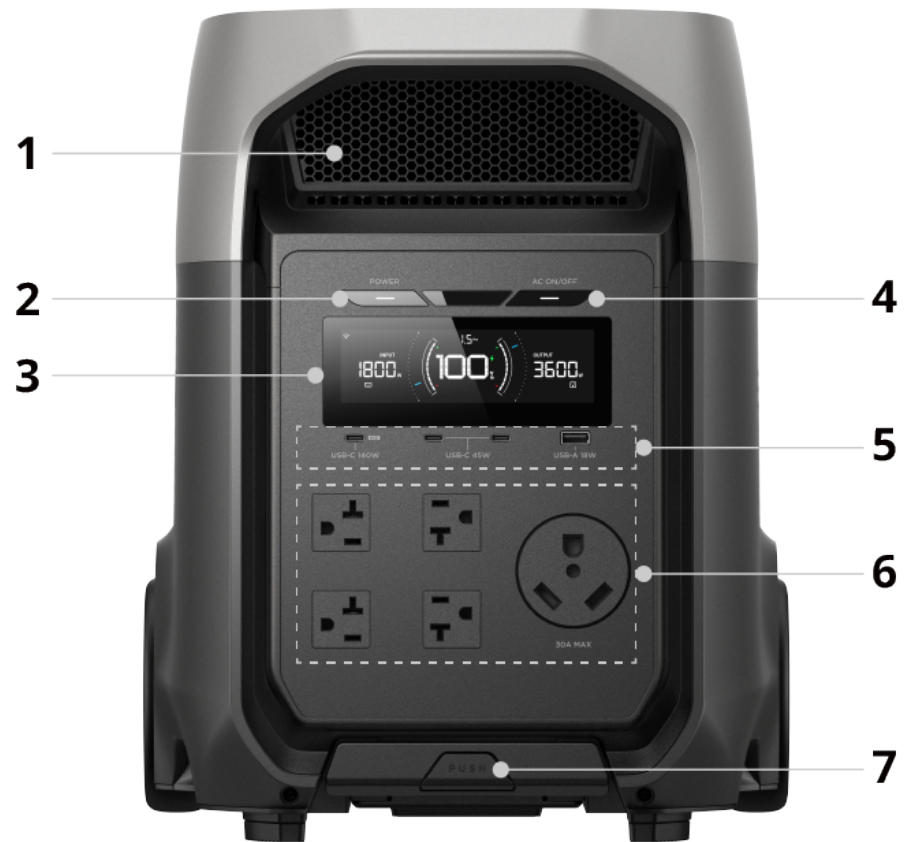

1	Air vent	Dissipate the internal heat.
2	Power button	Power on or off the device.
3	Display screen	Display operating status.
4	AC output button	Enable or disable the AC output sockets.
5	USB-C/USB-A output port	Supply power for small electronic device.
6	AC output socket	Supply power for AC load equipment. The AC output sockets and corresponding power cords vary depending on your country or region.
7	Telescopic handle button	Provide a handle to lift and carry the device.

Rear view



8	AC input socket	Connect the device to an AC power source for charging.
9	AC charging speed switch	<p>Switch between charging modes.</p> <ul style="list-style-type: none"> • ADJUST: Charge the power station at a customized speed that is set in the EcoFlow app. • FAST: Charge the power station at the maximum supported speed. <p>Note: This switch works only when charging the device with AC power.</p>
10	Solar/DC input port	Connect the device to the solar panel or vehicle's built-in cigarette lighter port for charging.
11	12V DC output button	Enable or disable the 12V DC output ports.
12	12V DC output port (cigarette lighter)	Supply power to 12V DC load equipment charging with cigarette lighter.

Display screen

Function bar



1	Wi-Fi	<p>On: The device is connected to a Wi-Fi network and the backend system.</p> <p>Blinking: The device is connected to a Wi-Fi network but not connected to the backend system.</p>
2	Bluetooth	<p>On: The device is connected to a Bluetooth device.</p>
3	Self-powered/Energy management mode	<p>On: The device is in self-powered/energy management mode. This mode allows the device to monitor your home's electricity consumption through the smart meter and delivers just the right amount of energy to minimize grid usage.</p>
4	TOU (Time of Use) mode	<p>On: The device is in TOU mode. This mode allows the device to charge and discharge according to electricity price schedules — charging when electricity rate is low and discharging when it is expensive.</p>
5	Scheduled task mode	<p>On: The device is in scheduled task mode. This mode allows the device to automatically charge batteries during off-peak evening hours and discharge during the day.</p>
6	Storm Guard	<p>On: The device is in Storm Guard mode. This mode allows the device to get fully charged 24 hours before extreme weather hits and lock energy until an outage occurs.</p>
7	Output port memory	<p>On: Output port memory is enabled. This function allows the device to retain its previous operational state or settings after an abnormal power loss, and automatically restore them once power is recovered.</p>
8	Disable grid bypass	<p>On: Grid bypass output is disabled. This function ensures the load is powered only by the battery backup instead of the utility grid.</p>
9	Fan status	<p>Rotating: The fan is operating normally.</p> <p>Blinking: The fan blade is physically blocked or stuck.</p>
		<p>On: AC Charging speed switch is set to ADJUST. The power station will be charged at user-defined speed.</p>

10 Adjustable AC charging speed **Off:** AC charging speed switch is set to FAST, and users are not allowed to customize the charging speed.

11 Charging/discharging limit **On:** The charge limit or discharge limit is set. The discharge limit is above 0% and the charge limit is below 100%.

Power input/output

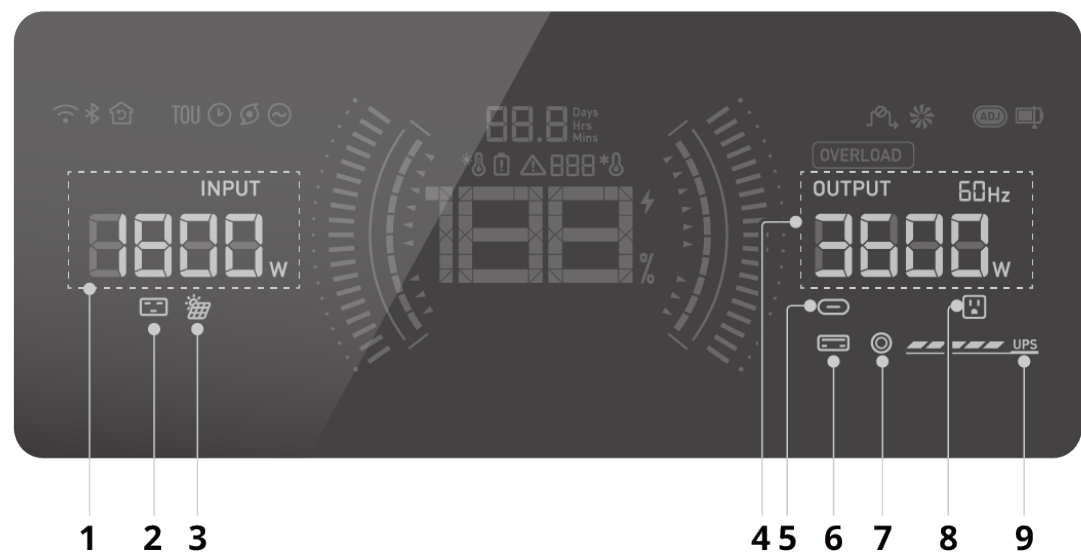

1 Total input	On: Display total input power from 0000 to 9999. Note: The value is 8888 during system upgrade.
2 AC input	On: The socket is connected and has power input. Blinking: The AC power input is experiencing a malfunction.
3 Solar/DC input	On: The port is connected and has power input. Blinking: Low light protection has been triggered, or the power input is experiencing a malfunction.
4 Total output	On: Display total output power from 0000 to 9999. Note: The value is 8888 during system upgrade.
5 USB-C output	On: The port is connected and has power output. Blinking: The power output is experiencing a malfunction.
6 USB-A output	On: The port is connected and has power output. Blinking: The power output is experiencing a malfunction.
7 12V DC output (cigarette lighter)	On: The port is connected and has power output. Blinking: The power output is experiencing a malfunction.
8 AC output	On: The socket is connected and has power output. Blinking: The AC power output is experiencing a malfunction.
9 UPS (Uninterruptible Power Supply)	On: The power station is connected to the grid and discharges through the bypass circuit. The power bars indicate discharging power capacity.

Battery

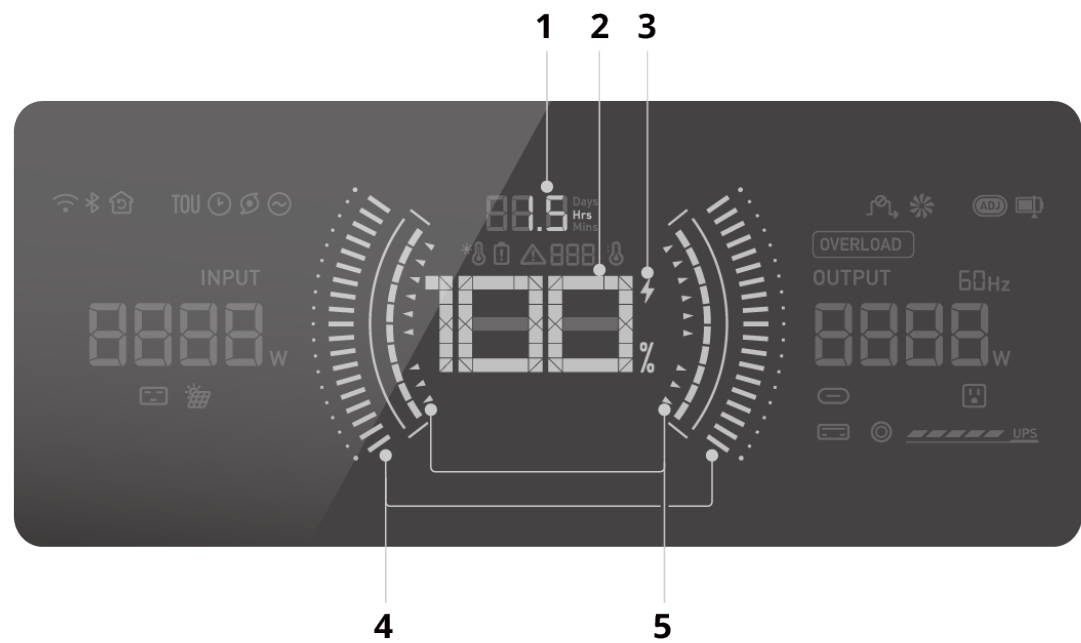

1	Remaining charging/discharging time	On: Display the ratio of the actual input power to the rated input power. From bottom to top, the segments represent 0% to 100%.
2	Battery level	On: Display current battery level.
3	Charging status	On: The device is under charging. Blinking: The charging is experiencing a malfunction.
4	Input/output power indicator	On: Display the ratio of the actual input/output power to the rated input/output power. From bottom to top, the segments represent 0% to 100%.
5	Charging/discharging limit	On: Display the preset charging limit (50%-100%) in green and discharging limit (0%-30%) in red.

Warning and error message

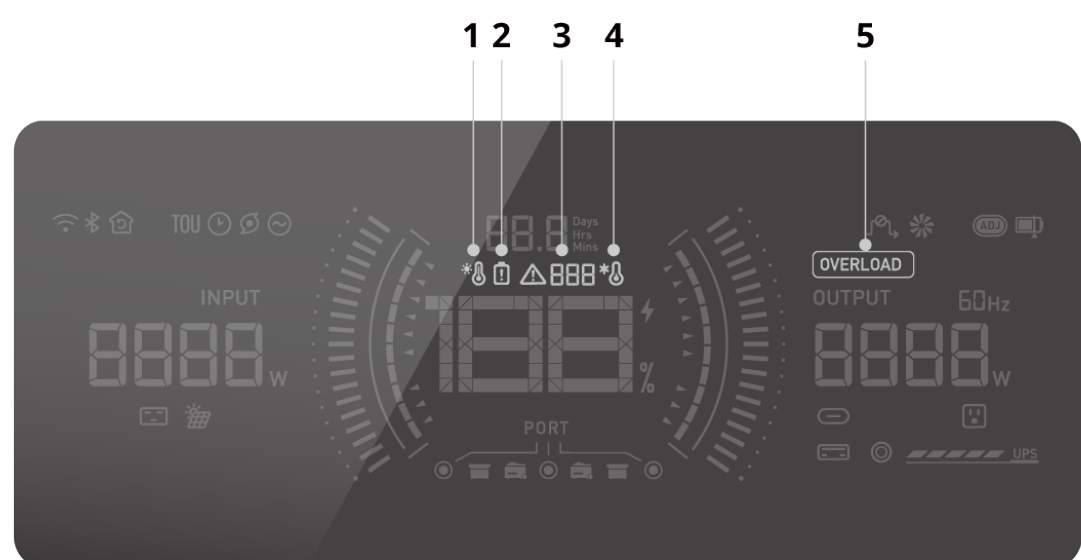

1	High temperature	Display pattern: Blinking Solution: Stop operation and move the device to a cool and well-ventilated spot.
2	Battery error	Display pattern: Blinking Solution: Check the EcoFlow in-app instructions for troubleshooting.

3	System error code	<p>Display pattern: On</p> <p>Note: If there are multiple errors at the same time, the error codes will be displayed in sequence, with each code shown for 3 seconds.</p> <p>Solution: Check the EcoFlow in-app instructions for troubleshooting.</p>
4	Low temperature	<p>Display pattern: Blinking</p> <p>Solution: Move the device to a warmer spot.</p>
5	Overload	<p>Display pattern: Blinking</p> <p>Solution: Disconnect some devices from the power station to decrease the overall power output.</p>

Specifications

General	
Model	EF-DL-H01-3U
Dimensions	626.0mm × 327.7mm × 395.0mm (81.02L)
Net weight	Approx. 32.7kg
Ingress protection rating	IP20
Monitoring mode	LCD
Fire resistance	UL94 5VA
Drop resistance	≤0.2m
Battery	
Rated capacity	3072Wh 51.2V \approx 60Ah
Cell chemistry	LFP (LiFePO4)
Protection type	<ul style="list-style-type: none"> • Overvoltage protection • Overload protection • Overtemperature protection • Short circuit protection • Low temperature protection • Low voltage protection • Overcurrent protection
Input	
AC input	<p>Charge only & Bypass mode:</p> <ul style="list-style-type: none"> • US/JP: 100-120V~15A 50/60Hz • BR_LV: 100-127V~10A 50/60Hz • CN/UK/EU/KR/AU/CH/ZA/BR_HV/INT: 220-240V~10A 50/60Hz

DC input

- Solar input: 11-60V=18A MAX, 800W
- DC input: 12V=8A MAX; 24V=8A MAX; 48V=16.6A MAX

Output

- Discharge only:
 - US: 120V~60Hz 3600W total (surge 7200W), 20A (×4) Max per port, 30A (×1) Max per port
 - JP: 100V~60Hz 3000w total (surge 6000W), 20A (×4) Max per port, 30A (×1) Max per port
 - BR_LV: 127V~60Hz 3600W total (surge 7200W), 20A (×4) Max per port
 - CN: 220V~50Hz 3600W total(surge 7200W), 13.6A (×1) Max per port, 10A (×3) Max per port
 - UK: 230V~50Hz 3600W total (surge 7200W), 13A (×4) Max per port
 - EU: 230V~50Hz 3600W total (surge 7200W), 13A (×4) Max per port
 - KR: 220V~60Hz 3600W total (surge 7200W), 13.6A (×4) Max per port
 - BR_HV: 220V~60Hz 3600W total (surge 7200W), 13.6A (×4) Max per port
 - AU: 230V~50Hz 3600W total (surge 7200W), 13A (×4) Max per port
 - CH: 230V~50Hz 3600W total (surge 7200W), 10A (×2) Max per port, 13A(×2) Max per port
 - ZA: 230V~50Hz 3600W total (surge 7200W), 13A (×2) Max per port, 13A(×2) Max per port
 - INT: 230V~50Hz 3600W total (surge 7200W), 13A (×4) Max per port
 - Bypass mode:
 - US:100-120V~50/60Hz 3600W total , 20A (×4) Max per port, 30A (×1) Max per port
 - JP:100-120V~50/60Hz 3000W total , 20A (×4) Max per port, 30A (×1) Max per port
 - BR LV:100-127V~50/60Hz 3600W total , 20A (×4) Max per port
 - CN: 220-240V~50/60Hz 3600W total, 16A (×1) Max per port, 10A (×3) Max per port
 - UK: 220-240V~50/60Hz 3600W total , 13A (×4) Max per port
 - EU: 220-240V~50/60Hz 3600W total , 15.6A (×4) Max per port
 - KR: 220-240V~50/60Hz 3600W total , 16A (×4) Max per port
 - BR_HV: 220-240V~50/60Hz 3600W total , 16A (×4) Max per port
 - AU: 220-240V~50/60Hz 3600W total , 15A (×4) Max per port
 - CH: 220-240V~50/60Hz 3600W total , 10A (×2) Max per port, 15.6A (×2) Max per port
 - ZA: 220-240V~50/60Hz 3600W total , 15.6A (×2) Max per port, 15.6A (×2) Max per port
 - INT: 220-240V~50/60Hz 3600W total , 13A (×4) Max per port
- Note: In bypass mode, ensure that the battery has enough power to achieve full AC output capacity. Low battery might

result in limited output power.

- DC output
- USB output port:
 - USB-A port (×1): 5V=3A / 9V=2A / 12V=1.5A, 18W MAX
 - USB-C port (×1): 5V=3A / 9V=3A / 12V=3A / 15V=3A / 20=5A / 28V=5A, 140W MAX
 - USB-C port (×2): 5V=3A / 9V=3A / 12V=3A / 15V=3A / 20V=2.25A, 45W MAX per port, total 45W
 - Cigarette lighter output port: 12.6V=10A, 126W MAX

Communication Wi-Fi / Bluetooth

Get started with your power station

Power on/off

To power on the device, press the power button once.

To power off the device, press and hold the power button for 2 seconds until the LED indicator changes.



- The device will be automatically powered on when it is connected to a power source.
- When the device is powered on, you can press the power button once to turn on or turn off the screen.

Power your appliances

Via USB output port

You can charge the portable and low-power electronic products by connecting

them to the USB (USB-A/USB-C) port on the device.

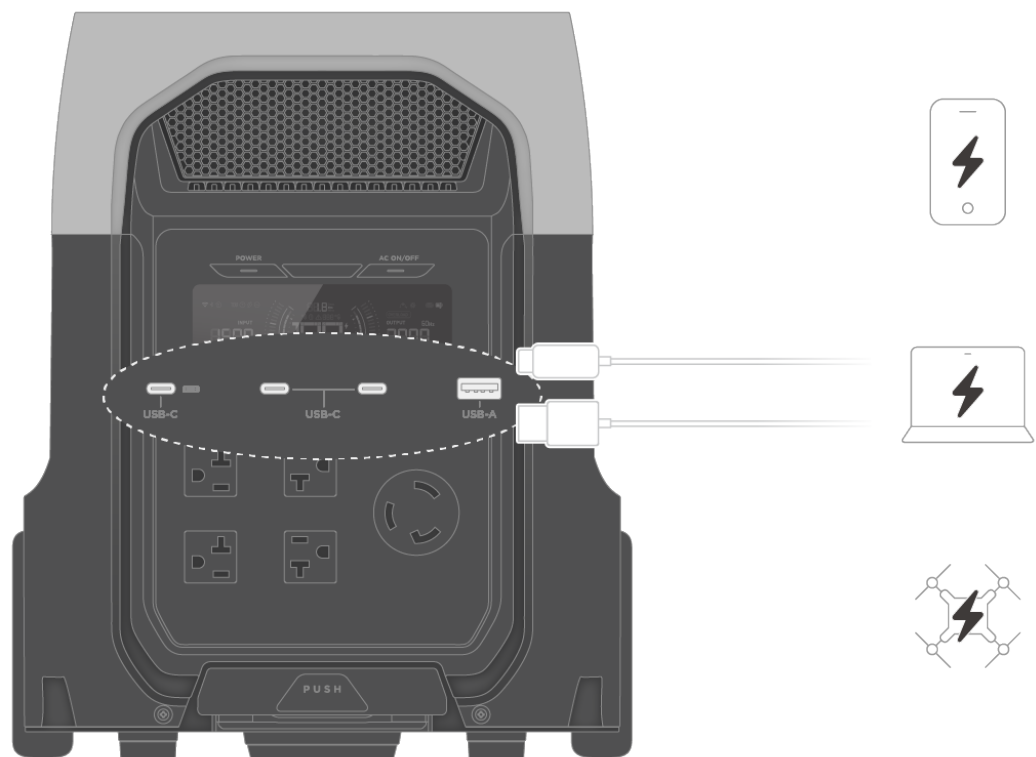

Via AC output socket

When the device is powered on, press the AC output button to enable the AC output socket as desired. Then, charge the AC load equipment by connecting them to the AC output socket.

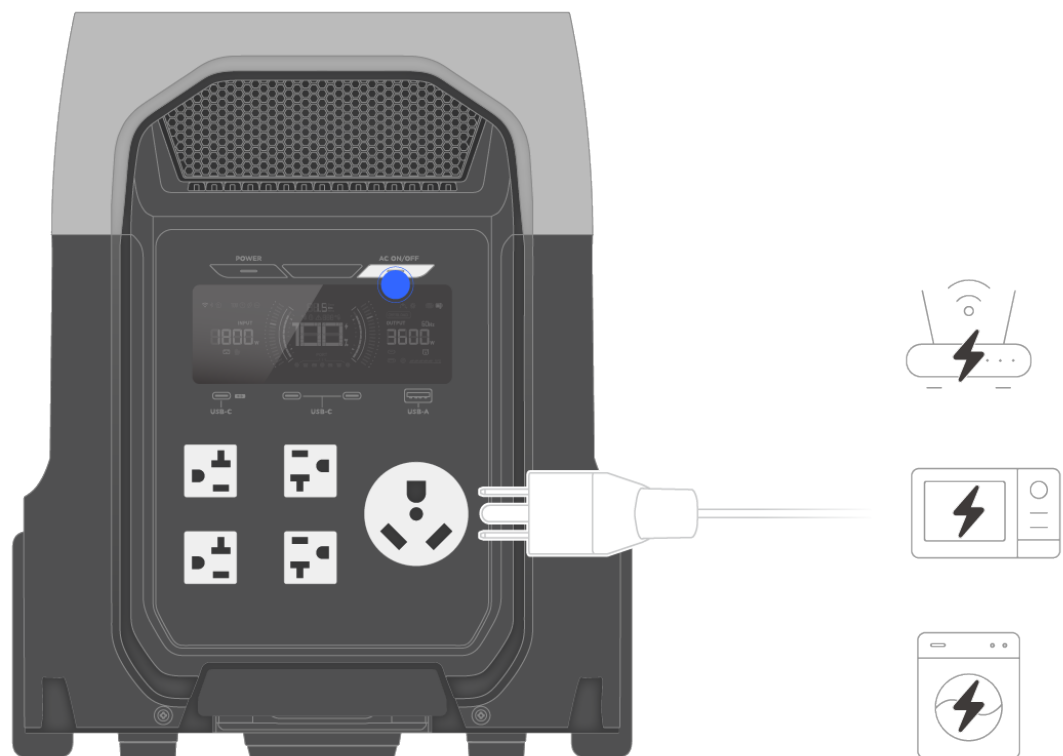

- The AC output sockets and corresponding power cords vary depending on your country or region.
- The AC output socket will be automatically disabled if it remains idle for a certain period. To ensure continuous power supply, set the AC timeout interval to Never in the EcoFlow app. Additionally, regularly check the power station's battery level.
- For appliances requiring high-quality power output, disable bypass mode in the EcoFlow app. Otherwise, unstable grid power might degrade the performance or cause damage to your appliances.

Via 12V DC output port

When the device is powered on, press the 12V DC output button to enable the 12V DC output port. Then, charge the DC load equipment by connecting them to the DC output port (cigarette lighter).

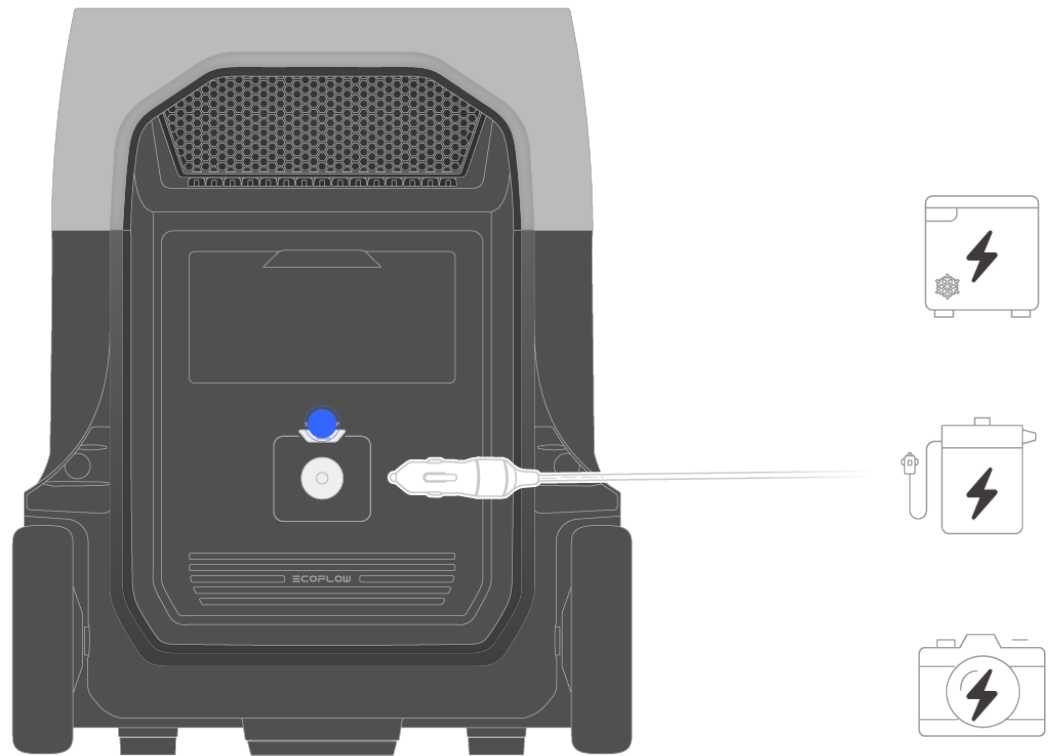

Charge your power station

Via wall outlet

You can charge the device by connecting it to the wall outlet.

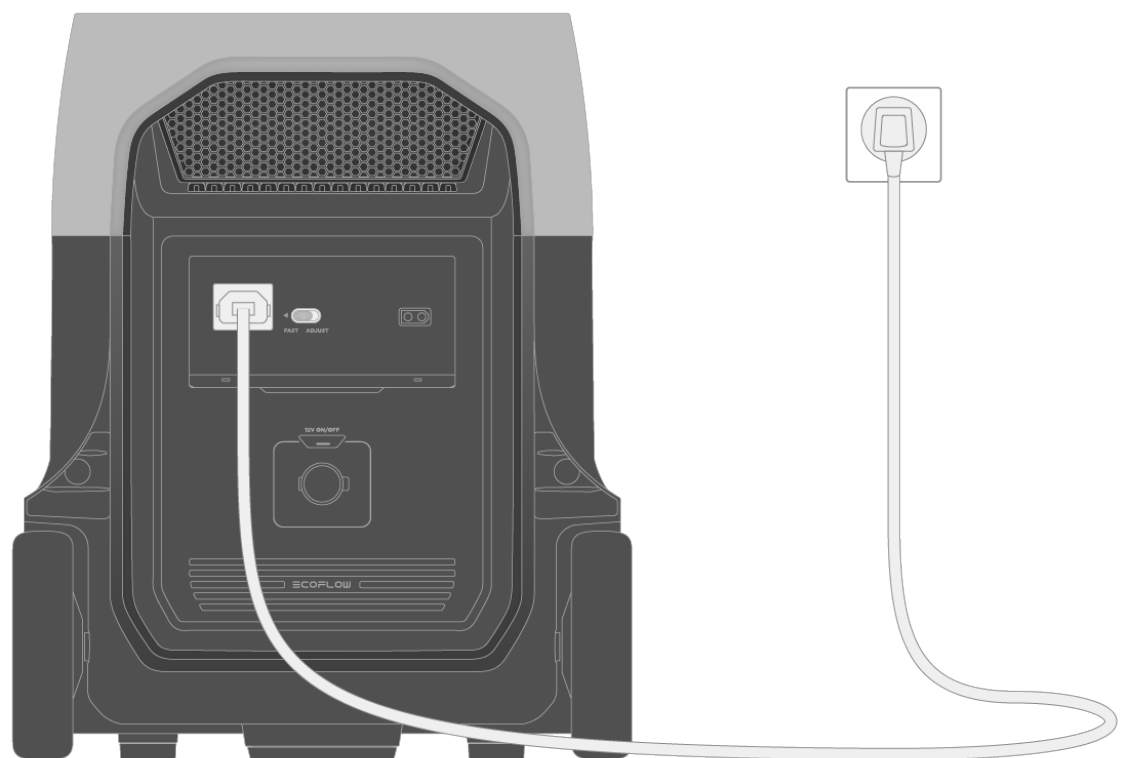

Via solar panel

You can charge the device by connecting it to the solar panel.

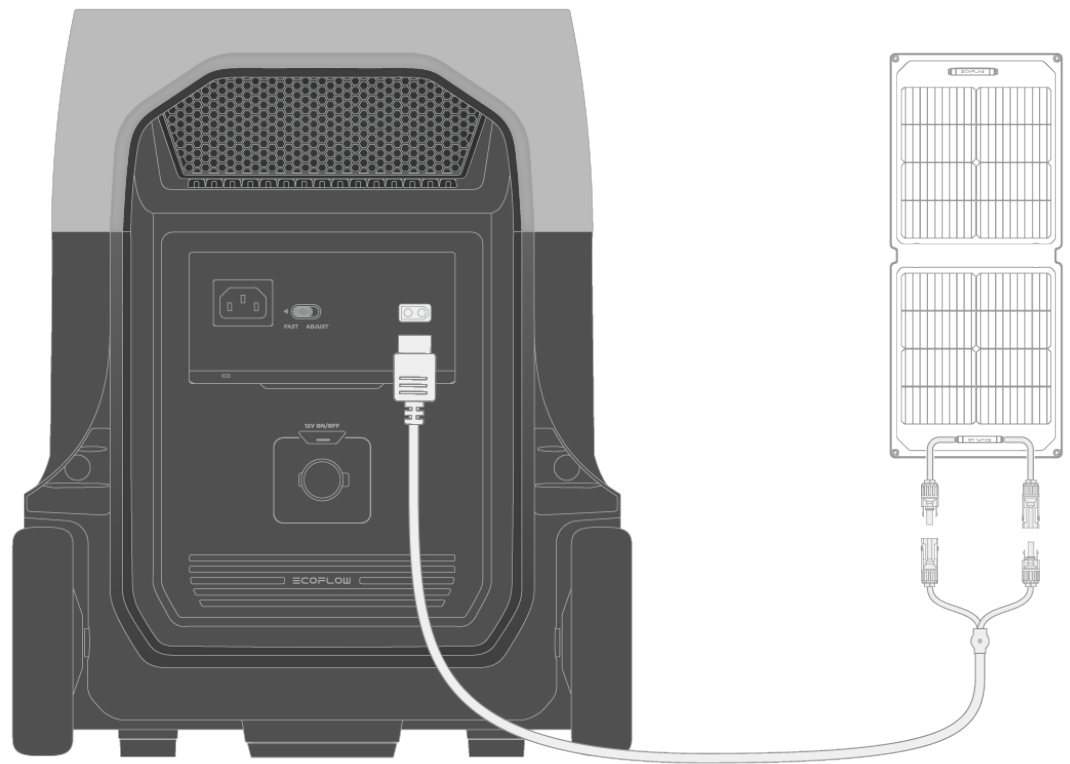

If you use more than one solar panel to charge the device at the same time, choose one of the following connection methods as desired:

- **Series connection:** It is recommended to use this connection method in sunny and unobstructed environment. This method increases the overall voltage, which can improve charging efficiency.

Notes:

- Ensure that the total voltage does not exceed the power station's maximum input limit.
- In this setup, keep all panels fully exposed to sunlight because the system is sensitive to shading. If one panel is blocked by shade, the performance of the entire array might decrease significantly.

- **Parallel connection:** It is recommended to use this connection method in an environment where sunlight might be partially blocked, such as under trees, in cloudy weather, or when panels are positioned at different angles. This method keeps the voltage stable while increasing the total current, making charging more reliable and consistent.

Notes:

- Ensure that the total current does not exceed the power station's maximum input rating.
- In this setup, you can use T-Branch/Y-Branch cables or standard parallel cables depending on your preferences and specific needs.

For more information or instruction on series or parallel connections, refer to the solar panel's user manual.

Via cigarette lighter

You can charge the device by connecting it to the vehicle's cigarette lighter.

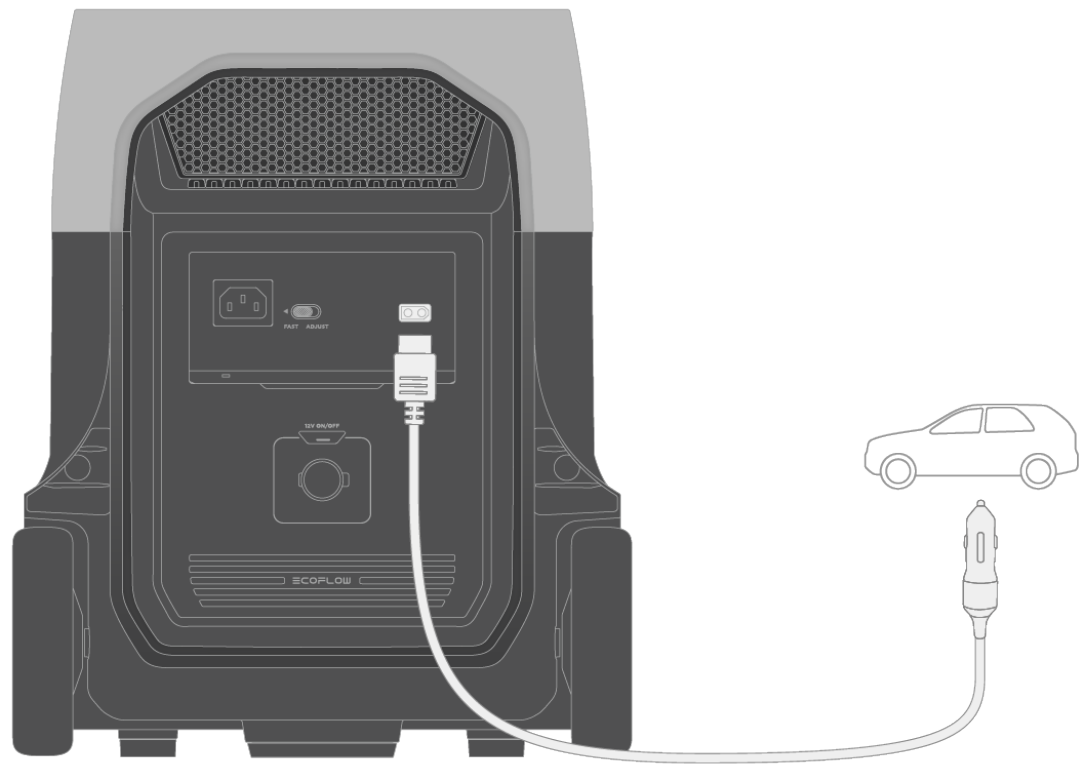

- Ensure that the vehicle engine is running when charging your device to avoid draining the vehicle's battery.
- The charging time might be longer than other charging methods such as wall outlets or solar panel because the current provided by the vehicles's cigarette lighter is generally lower.

Via generator

You can charge the device by connecting it to a compatible generator.

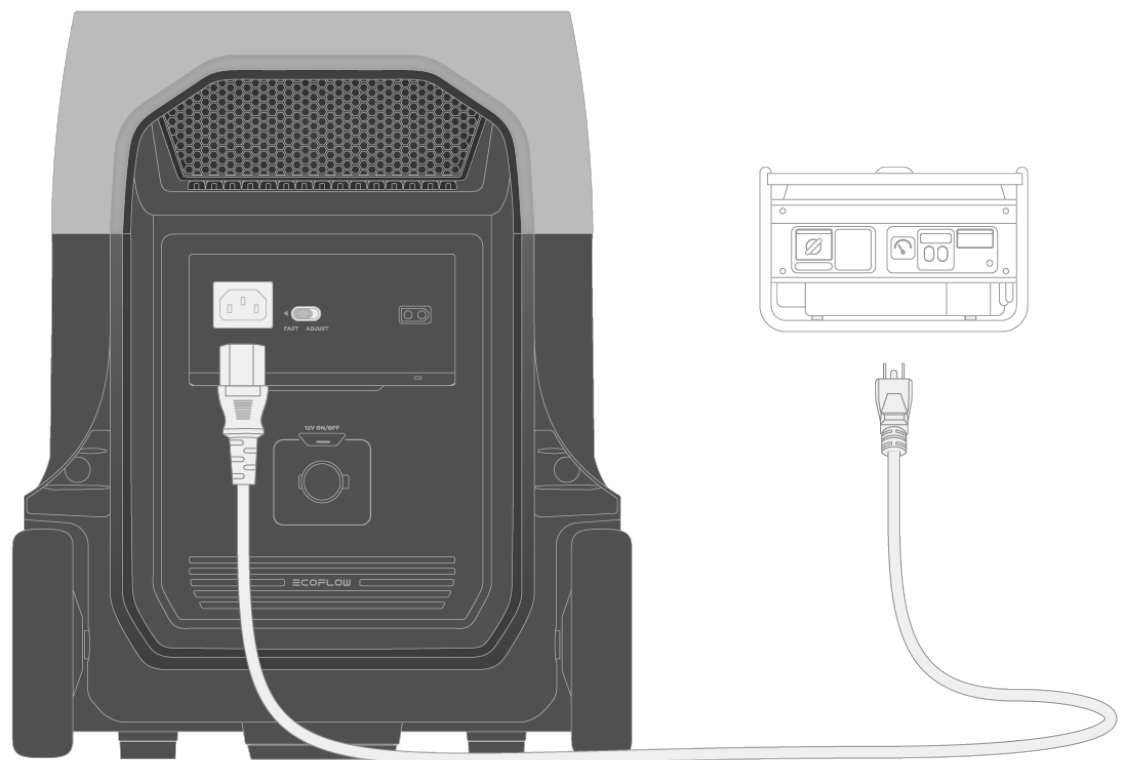

- Ensure that the generator is used in a well-ventilated spot away from flammable materials, preferably outdoors, to avoid fire and carbon monoxide poisoning. For detailed instructions, see the attached user documentation with the generator.

Manage your power station

Use EcoFlow app

Download the EcoFlow app

The EcoFlow app is a customized one-stop solution for you to monitor the status of all your devices in real time, manage them from one place, control from afar, and customize all settings, such as battery life, input/output, and more.

To download the EcoFlow app, choose one of the following methods:

- Scan the QR code.
- Search EcoFlow in iOS and Android APP Store.
- Go to <https://download.ecoflow.com/app>.

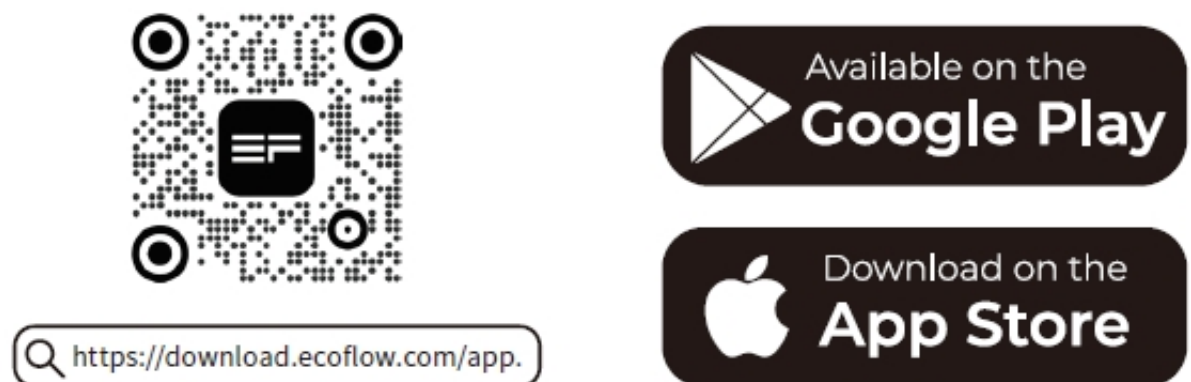

Add the device and connect to the network

You can add the device into the EcoFlow app to manage and control it anywhere at any time.

To add the device and set up the Internet, do the following:

1. Open the EcoFlow app and log into your account. If you don't have an account, you need to create a new account.
2. Tap the button that instructs you to add a device.
3. Select the device as from the device list and follow the on-screen instructions to add the device and set up the Wi-Fi network.



You can skip Wi-Fi connection when you add the device for the first time and set up the network later.

General settings

After binding your device to EcoFlow account, you can manage the settings such as:

- Rename your device.
- Share your device with others.
- Customize power input or output.
- Set charge and discharge limit.
- Change operating mode.
- Upgrade firmware.

For specific functions and settings of your device, refer to your EcoFlow app. You can set your device based on the use scenario and preference.



This app might make periodic updates of the features. Explore this app on the actual user interface.

Use EcoFlow PowerInsight

EcoFlow PowerInsight is an all-in-one intelligent energy monitor designed to manage and optimize home energy consumption. By integrating EcoFlow PowerInsight with your power station, you can monitor real-time energy usage, optimize energy use and save costs, remotely control the device, receive instant notifications, update the power station's firmware.

To purchase a EcoFlow PowerInsight, go to <https://www.ecoflow.com>. For detailed information, see the attached user documentation with EcoFlow PowerInsight.

Explore your power station

Maximize power output

X-Boost: Run high-wattage appliances that exceed the rated output

X-Boost is an innovative technology that supports appliances that exceed the rated output by adjusting the voltage, allowing it to start without overloading. With X-Boost enabled, your power station supports appliances with higher output, to run all kinds of household appliances, from electric water heaters to central air conditioning with a single unit.

X-Boost is enabled by default. To change the settings of this function, do the following:

1. Open the EcoFlow app and log into your account.
2. Turn off the X-Boost switch in settings.

For power with the X-Boost feature, refer to the following table:

AC output voltage (V)	Rated power (W)	Power with X-Boost (W)
100	3000	3800
120	3600	4600
127	3600	5100
220	3600	4300
230	3600	4700



- X-Boost is more suitable for heating devices, such as an electric blanket, a water heater, or a heat pump. X-Boost does not support devices with voltage protection (such as precise instruments). If such devices are connected, they may stop working due to low voltage.
- X-Boost is unavailable when the power station is being charged via an AC power source (e.g. when the power station is in bypass mode).

X-Fusion: Power high-wattage appliances beyond AC limits

When in bypass mode and connected to the grid to power appliances via an AC outlet, X-Fusion ingeniously overrides grid electricity with inverter power to overcome the grid's maximum output.



- X-Fusion is a built-in feature that requires no additional configuration.
- Ensure that your local circuits support high current loads and meet safety requirements.
- In bypass mode, ensure that the battery has enough power to achieve full AC output capacity. Low battery might result in limited output power.

Maintain uninterrupted power

When connected to the grid, the power station functions as a reliable UPS (uninterruptible power supply), a device or system provides continuous backup power during grid power outage. In the event of a sudden power outage, it automatically switches to battery power within 10 ms, ensuring your connected devices stay up and running without interruption.



In this setup, the power station should draw more power from the grid than it delivers to connected loads. The excess power is used to charge and maintain the internal batteries. If the input power is insufficient, the batteries may not charge properly, and the power station may fail to operate reliably as a backup power source.

Store and maintain your power station

Storage

- Store the device in an dry, cool, well-ventilated environment where the temperature is between -10°C and 45°C , with a recommended range of approximately 0°C to 30°C to maintain battery health.
- Place the device on a flat and non-slip surface to reduce the risk of falling.
- Ensure the device is kept away from water sources, heat sources, strong magnetic fields, environments with corrosive gases, and any flammable or

- explosive substances.
- For long-term storage, charge and discharge the product every 3 months (fully charge it, then discharge to 60% for storage) to maintain battery health.
- Do not leave the device unused or without charging for more than six months, as this will void the warranty.

Cleaning

- Before cleaning, power off the device and unplug all cables.
- Use a soft and dry cloth to wipe the surface.
- Do not use water, solvents, or chemical cleaners that might damage internal components or ports.
- Do not spray any liquid directly onto the device.
- Do not disassemble the device to clean internal components. Improper operation might void the warranty and cause safety hazards.

Maintenance

- Periodically check for dust or debris in vents or ports and clean the device if needed.
- Do not deeply discharge the device frequently, otherwise the battery lifespan will be shortened.
- Ensure all cables and connectors are intact and not frayed or damaged.
- Store and operate the device within the recommended temperature and humidity range.
- If the device shows any signs of abnormal symptoms (e.g., unusual heat, smell, noise), stop using it immediately and contact customer support.
- Do not open or disassemble the device under any circumstances. If your device needs to be serviced, contact our customer support.
- Ensure that air vent is unobstructed during use to avoid overheating.

Regulatory compliance

FCC Compliance Statement

Any Changes or modifications not expressly approved by the party responsible for compliance could void the user's authority to operate the equipment.

This device complies with part 15 of the FCC Rules. Operation is subject to the following two conditions:

- (1) This device may not cause harmful interference, and
- (2) this device must accept any interference received, including interference that may cause undesired operation.

This equipment has been tested and found to comply with the limits for a Class B digital device, pursuant to Part 15 of the FCC Rules. These limits are designed to provide reasonable protection against harmful interference in a residential installation. This equipment generates uses and can radiate radio frequency energy and, if not installed and used in accordance with the

instructions, may cause harmful interference to radio communications. However, there is no guarantee that interference will not occur in a particular installation. If this equipment does cause harmful interference to radio or television reception, which can be determined by turning the equipment off and on, the user is encouraged to try to correct the interference by one of the following measures:

- Reorient or relocate the receiving antenna.
- Increase the separation between the equipment and receiver.
- Connect the equipment into an outlet on a circuit different from that to which the receiver is connected.
- Consult the dealer or an experienced radio/TV technician for help.

RF exposure statement

This equipment complies with the FCC radiation exposure limits set forth for an uncontrolled environment. This transmitter must not be co-located or operating in conjunction with any other antenna or transmitter.

Industry Canada compliance

This device complies with Industry Canada licence-exempt RSS standard(s) Operation is subject to the following two conditions:

- (1) this device may not cause interference, and
- (2) this device must accept any interference, including interference that may cause undesired operation of the device.

Le présent appareil est conforme aux CNR d'Industrie Canada applicables aux appareils radio exempts de licence. L'exploitation est autorisée aux deux conditions suivantes:

- (1) l'appareil ne doit pas produire de brouillage, et
- (2) l'utilisateur de l'appareil doit accepter tout brouillage radioélectrique subi, même si le brouillage est susceptible d'en compromettre le fonctionnement.

This Class B digital apparatus complies with Canadian ICES-003.

Cet appareil numérique de la classe B est conforme à la norme NMB-003 du Canada.

CAN ICES(B) / NMB(B)

Radiation Exposure Statement / Déclaration d'exposition aux radiations

This equipment meets the exemption from the routine evaluation limits in section 2.5 of RSS-102. It should be installed and operated with a minimum distance of 20cm between the radiator and any part of your body.

Cet équipement est conforme à l'exemption des limites d'évaluation habituelle de la section 2.5 de la norme RSS-102. Il doit être installé et utilisé à une distance minimale de 20 cm entre le radiateur et toute partie de votre corps.

CE Hereby, EcoFlow Inc. declares that this product is in compliance with Directives 2014/53/EU, 2011/65/EU+(EU)2015/863, (EU)2023/1542. The full text of the EU Declaration of Conformity is available at the following Internet address: <http://www.ecoflow.com/eu/eu-compliance>.

Radio Frequency (RF) Specifications for EU:

Bluetooth:

- Frequency: 2402-2480 MHz
- Maximum Output Power: <20 dBm

WLAN

- Frequency: 2412-2472 MHz / 2422-2462 MHz
- Maximum Output Power: <20 dBm



This marking indicates that this product should not be disposed of with other household waste within the EU. Recycle this product properly to prevent possible damage to the environment or a risk to human health via uncontrolled waste disposal and in order to promote the sustainable reuse of material resources. Please return your used product to an appropriate collection point or contact the retailer where you purchased this product. Your retailer will accept used products and return them to an environmentally-sound recycling facility.

For information on the disposal of electrical and electronic equipment, please visit the following website:

<https://eu.ecoflow.com/pages/electronic-devices-disposal>.

Copyright © 2025 EcoFlow. All Rights Reserved.