



PLEASE READ THESE INSTRUCTIONS  
BEFORE USING THIS APPLIANCE.



## eR7 Users Guide

LPRT 517763  
07/24 EINS 517764

# My AGA Details

AGA eR7

Serial No \_\_\_\_\_

AGA Service No \_\_\_\_\_

Date of Installation \_\_\_\_\_



For further advice or information contact your local AGA specialist.

With a policy of continuous product improvement, AGA Rangemaster reserves the right to change specifications and make modifications to the appliance described and illustrated at any time.

© AGA Rangemaster Limited 2019

AGA is a trading name of AGA Rangemaster Ltd. AGA brand names, words and logos are registered trademarks of the AGA Rangemaster Ltd, Meadow Lane, Long Eaton, Nottingham NG10 2GD





[www.agaliving.com](http://www.agaliving.com) | [www.agacookshop.co.uk](http://www.agacookshop.co.uk)

# Contents

---

Warnings	3	The ovens	36
Introduction	4	Slumber mode	37
A brief description - AGA eR7	5	The roasting oven	38
A brief description - AGA eR7 hotcupboard	7	The baking oven	40
Equipment supplied with your AGA eR7	9	The simmering oven	41
AGA Utensils and Accessories	13	The simmering oven	42
Getting to know your AGA	13	AGA Hotcupboard	43
How to use your AGA eR7	14	Caring and cleaning	44
AGA eR7 Operating hobs and ovens	16	Important	45
Cooking on your AGA eR7	20	Fitting of oven shelves	46
Oven venting	21	Removal of oven shelves	46
General advice	22	Servicing and warranty	47
Handset - A hand held control	23	Serial number	47
Screens	23	Health & safety	47
Button operations	23	Deep fat frying	48
Handset advice	24	AGA basic recipes	49
Communication/handshake	25		
The date/time setting screen	27		
Auto/events programme screen	29		
Information (home) screen	31		
Batteries	33		
Using the zones of the AGA eR7	34		
The hotplates	34		
The boiling plate	35		
The simmering plate	35		
The top plate	36		

## Warnings

-  **WARNING:** The appliance and its accessible parts become hot during use. Care should be taken to avoid touching heating elements. Children less than 8 years of age should be kept away unless continuously supervised.
-  The appliance can be used by children aged from 8 years and above and persons with reduced physical, sensory or mental capabilities or lack of experience and knowledge if they have been given supervision or instruction concerning use of the appliance in a safe way and understand the hazards involved. Children should not play with the appliance. Cleaning and user maintenance should not be made by children without supervision.
-  **WARNING:** Unattended cooking on a hob with fat or oil can be dangerous and may result in fire. NEVER try to extinguish a fire with water, but switch off the appliance and then cover flame e.g. with a lid or fire blanket.
-  **WARNING:** Danger of fire: DO NOT store items on the cooking surfaces.

## Introduction

Your new AGA eR7 gives you everything you love about the classic AGA heat storage cooker, but with the ability to turn each cooking area on and off, and the added convenience of touchscreen control to select from a range of cooking temperatures.

Made in the heart of Shropshire, your AGA cooker, like the generations of cookers before it, has been manufactured from cast iron. Traditional iron-making skills combined with industrial strength elements enable the ovens and hotplates to heat up rapidly, so you can have them all on, or just one.

The cooking excellence of the AGA cooker has been famous since it's inception in the 1920's, and is renowned due to the indirect radiant heat that its cast iron emits rather than just air temperature. And, if you haven't found out already, you'll soon discover that food that is cooked this way retains its natural flavour and succulence, and simply just tastes better.

So grab a cup of tea, have a read, and prepare to dig into some of the tastiest dishes you're ever likely to make.

## A brief description - AGA eR7



## Hotplates

The two hotplates are at different heats; the boiling plate being the hottest of the two and the simmering plate at a lower heat. Each hotplate is individually temperature controlled.

### **Boiling plate**

The boiling plate is used for making toast, boiling a kettle, stir-frying and cooking at a high heat.

### **Simmering plate**

The simmering plate is for cooking slower, such as sauces, simmering pans and can also be used direct on for toasted sandwiches, drop scones, non-fat fried eggs and quesadillas. (Use of Bako-Glide will protect the hotplate surface during 'direct on' cooking)

### **Roasting oven**

The hottest oven for high temperature cooking pastries, breads, roasting of meat, vegetables and poultry, grilling at the top of the oven and frying on the floor. The oven has 5 pre-set cook settings R9, R8, R7, R6 and B4 which gives the flexibility to vary the oven temperature from very hot to moderate. The oven, as the others, is vented into the room, so some cooking smells will be present.

### **Baking oven**

A moderate oven for cooking cakes and biscuits, baking fish, lasagne or shepherd's pie, plus roasting meat and poultry at a medium heat. The oven has 4 pre-set cook settings B4, B3, B2 and B1 which gives the flexibility to vary the oven temperature from moderate to cool. Cooking sweets and savoury together is no problem as the flavours do not mix.

### **Simmering oven**

Long, slow cooking in the simmering oven develops flavours and makes the toughest meat tender. Its large capacity means several pans can be stacked here; soup, casserole, steamed rice, steamed carrots and poached pears all cooking simultaneously, without any danger of burning. The oven has a fixed temperature.

## A brief description - AGA eR7 hotcupboard





## Hotplates

The two hotplates are at different heats; the boiling plate being the hottest of the two and the simmering plate at a lower heat. Each hotplate is individually temperature controlled.

### Boiling Plate

The boiling plate is used for making toast, boiling a kettle, stir-frying and cooking at a high heat.

### Simmering Plate

The simmering plate is for cooking slower, such as sauces, simmering pans and can also be used direct on for toasted sandwiches, drop scones, non-fat fried eggs and quesadillas. (Use of Bako-Glide will protect the hotplate surface during 'direct on' cooking)

### Warming Plate (Hotcupboard)

The warming plate is the ideal resting place for cooked food.

### Slow Cooking Oven (Hotcupboard)

Ideal for a broad range of long slow cooking applications, such as leg of lamb, pulled pork, belly pork and celebration cake.

**NOTE:** Meat and vegetable dishes should be started on the boiling plate or in the roasting oven.

### Warming Oven (Hotcupboard)

Used for warming plates and serving dishes. Can also be used for resting joints before carving.

### Roasting Oven

The hottest oven for high temperature cooking pastries, breads, roasting of meat, vegetables and poultry, grilling at the top of the oven and frying on the floor. The oven has 5 pre-set cook settings R9, R8, R7, R6 and B4 which gives the flexibility to vary the oven temperature from very hot to moderate. The oven, as the others, is vented into the room, so some cooking smells will be present.

### Baking Oven

A moderate oven for cooking cakes and biscuits, baking fish, lasagne or shepherd's pie, plus roasting meat and poultry at a medium heat. The oven has 4 pre-set cook settings B4, B3, B2 and B1 which gives the flexibility to vary the oven temperature from moderate to cool. Cooking sweets and savoury together is no problem as the flavours do not mix.

### Simmering Oven

Long, slow cooking in the simmering oven develops flavours and makes the toughest meat tender. Its large capacity means several pans can be stacked here; soup, casserole, steamed rice, steamed carrots and poached pears all cooking simultaneously, without any danger of burning. The oven has a fixed temperature.

## Equipment supplied with your AGA eR7



---

### Large Size Roasting Tin with Grill Rack

This is designed to slide onto the oven runners without the need for it to sit on an oven grid shelf. The roasting tin can be used with the grill rack, in its high position, for grilling at the top of the roasting oven. It can be used for roasting meat, or poultry with or without the grill rack. Large quantities of roast potatoes can be cooked in this tin. The roasting tin can also be employed for making large traybakes or cakes. The grill rack is useful on its own as a cake cooling rack. Can be used in any oven but not recommended for hotplate use.



---

### Half Size Roasting Tin and Grill Rack

This tin can be slid onto the oven runners width-ways or can sit on an oven grid shelf. The half size roasting tin can be used with the grill rack, in its high position, for grilling at the top of the roasting oven. It can be used for roasting smaller joints of meat, or poultry with or without the grill rack. Roast potatoes can be cooked in this tin. The roasting tin can also be employed for making traybakes or cakes. The grill rack is useful on its own as a cake cooling rack. It can be used in any oven but not recommended for hotplate use.

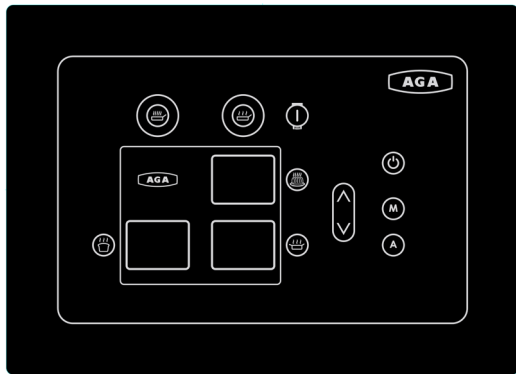

---

### Control Panel

This is situated behind the top left hand door. The control panel has a capacitive touch screen with LED indicators and character display to indicate which zone is activated and what setting is selected. An audible beep will confirm selection.



---

### Handset

Your AGA eR7 cooker also comes with a Handset which can be used to programme the ovens. It displays the time, date and programme events. The hotplates work on Manual only.

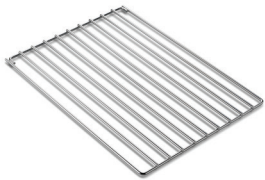

---

### 1 Floor Grid

This grid is used on the floor of the ovens, in particular the roasting and simmering ovens to protect food needing over 30 minutes cooking from the intensity of the heat from the base element.

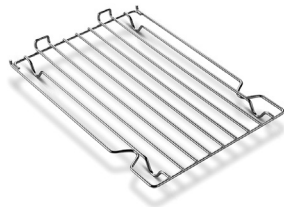

---

### 3 Oven Grid Shelves

These are for inserting in each oven to provide a surface for dishes and tins which do not fit direct onto the oven runners. They can be used in any oven, as required. **“Fitting of oven shelves” page 46** on how to locate the oven shelves correctly.

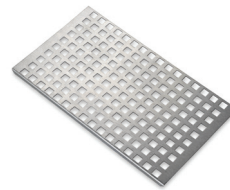

---

### Roasting Oven Perforated Baffle

A roasting oven perforated baffle is positioned in the top of the roasting oven, in order to optimise cooking performance. For best results, please ensure it is in place at all times, while the oven is in operation, including when grilling. The Installation Engineer will fit this in place. This can also be removed for cleaning.



---

### **Toaster**

This is for toasting bread on the boiling plate. AGA toast is renowned for its excellence, crisp on the outside and soft in the centre. Take thick slices of bread and place in the AGA toaster - if the bread is very moist or very fresh, heat the toaster beforehand to prevent sticking - lift the boiling plate insulated cover and place the toaster direct onto the plate with the handle at an angle from the handle of the cover.

Close the cover and wait for the bread to toast one side - this will take 1-2 minutes dependent upon the variety of bread - open the cover and turn the toaster over and repeat the process to toast the other side. The toaster can also be used for heating pitta bread, toasting teacakes and as a cake cooling rack.



---

### **Wire Brush**

This is for cleaning the raw cast iron hotplate surfaces, keeping them clear of crumbs and burnt on debris - which would otherwise affect the boiling performance of pans and the kettle. Use on the hotplates and the ovens. Take care not to touch the enamel surfaces as the wire brush will scratch the finish.



---

## **AGA Utensils and Accessories**

To get the very best performance from your cooker we recommend AGA saucepans with the thick tri-core bases and stacking lids so that the maximum use of oven space is made and an AGA kettle for boiling water. AGA Accessories can be viewed at your AGA Specialist or online at [www.agacookshop.co.uk](http://www.agacookshop.co.uk)

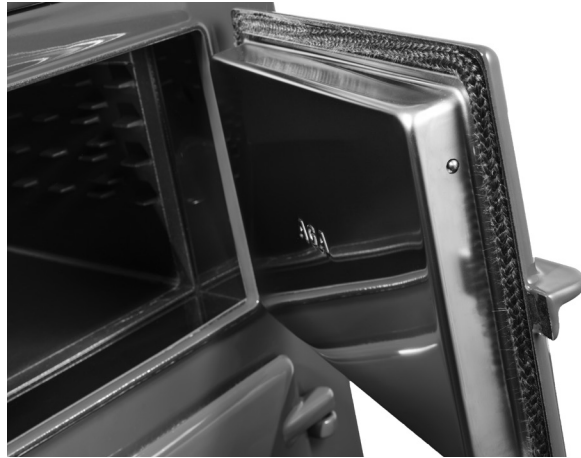

---

## **Getting to know your AGA**

If you have not already seen a demonstration, ask your AGA Specialist for details. A demonstration will show you how to get the best from your new AGA and will give you hints and tips. You will also see a selection of AGA utensils and accessories being used.

# How to use your AGA eR7

## Getting started

When switching on the AGA cooker for the first few times, there are two things you may notice, neither of which should cause concern.

The AGA cooker will emit an odour for a short while, this is simply due to the protective oil we put on the hotplates and ovens burning off. Due to the newness in the first couple of hours, it is advisable to open the kitchen window while this takes place.

Condensation may occur on the top and front plate whilst the AGA cooker is heating up, caused by the insulation lagging and starch binder on the element insulation drying out. The condensation should be wiped away as soon as possible to prevent staining the enamel.

Your AGA eR7 has the external appearance of a classic AGA heat storage enamelled cast iron cooker. However its flexibility is almost unbounded because in place of a single heat source each cooking zone has its own electrically heated cast iron element(s). The separation of cooking zones, allows a choice of control. You are able to select only the zones that you want, or need, to use.

The control panel is situated behind the top left hand door and has a capacitive touch screen with LED indicators and character display to indicate which zone is activated and what setting is selected. An audible beep will confirm selection.







## AGA eR7 Operating hobs and ovens

### Hob

To turn on the cast iron hotplates press on/off button  to turn on the power to the appliance. The 'Power ON/OFF' button and 'Manual Select' button will light up.

Press the Hob power button  which illuminates to indicate the hotplate and simmer buttons are ready to be activated. If the hotplate or simmer plate is not selected within 3 seconds the 'Hob Power' button will deactivate.

With the 'Hob Power' button active the hotplate and/or simmer plate can be turned on by pressing the centre of the symbol  . The symbol outer ring will blink until the desired temperature is reached, at which point the LED will become solid.

### Options to turn the hobs Off

De-select the hotplate or simmer plate by pressing the illuminated symbol. The LED will turn off to indicate that hob is no longer active. After 3 seconds of both hotplate and simmer plate being de-selected the 'Hob Power' LED will automatically deactivate.

Both the hotplate and simmer plate can be turned off together by pressing the 'Hob Power' button .

To turn OFF all zones press on/off button (Ovens & Hob) .

## Ovens

The appliance has 4 oven operating modes:

- MANUAL
- SLUMBER
- AUTO
- AUTO-SLUMBER



Selection can only be made when the on/off button is on.

### Manual mode *(ovens only)*

In this mode, all three ovens can be activated and the desired cooking temperature selected.

Press on/off button  to switch on the power to the appliance.

The 'M' button  will be illuminated to indicate the appliance is in manual mode.

Each oven can be selected by pressing the appropriate button.   

The selected oven will blink until the desired temperature is reached. For the roast and bake ovens the oven setting will also be displayed in the relevant window (Roast oven – 'R8' and Bake oven – 'B4').

To change the oven setting, press the desired button, a red selection bar will appear under the relevant window to indicate the setting can be changed.

Use the UP  or DOWN  arrows to change the setting. The red selection bar will remain active for 30 seconds.

To turn OFF a single oven press the desired button.



For the roast and bake ovens, the button is to be pressed twice, once to select and once to switch OFF.

To turn OFF all zones press on/off button (Ovens & Hob)







### Slumber setting *(ovens only)*

In this mode, all three ovens are active, (the roasting and baking oven are pre-set to approximately 120°C, the simmering oven is pre-set to approximately 100°C).

Press on/off button  to switch on the power to the appliance.

Press and hold the 'M' button  for 3 seconds, which will blink to indicate slumber mode is selected.

The 3 oven symbols will illuminate    and blink until at the desired temperature. The settings display window for the roast and bake ovens will display the letter "S" to indicate slumber mode.

To cancel Slumber, press and hold the 'M' button  for 3 seconds or press on/off button  to turn OFF all zones (Ovens & Hob).

### To override an oven setting while in slumber mode

No individual oven can be 'OFF'. However the roast or bake oven can be switched from 'Slumber' to a cooking setting. This is achieved by pressing the relevant symbol once. A selection bar will appear under the relevant oven and the default setting is displayed. (Roast oven – 'R8' and Bake oven – 'B4') The desired setting can then be selected by using the arrow buttons as previously described.

Pressing an individual oven button once more returns that oven back to 'Slumber'

If both roast and bake ovens are overridden the appliance will revert back to manual mode and the 'M' button  will become solid to indicate it is no longer in slumber mode.

### Auto

This mode setting brings selected ovens up to full heat from off.

The ovens can be selected to operate once or twice each day.

Each operation is termed an 'event', the start and finish time is chosen by you unless you use the pre-set time.

Press on/off button  to switch on the power to the appliance.

Press 'A' button , which illuminates to indicate the cooker is in Auto mode.



Select oven (s) for automatic operation, by pressing the appropriate button (s).   

Select the desired cook setting by using the arrow symbols. Press the desired button, a red selection bar will appear under the relevant window to indicate the setting can be changed.

Use the UP  or DOWN  arrows to change the setting. The red selection bar will remain active for 30 seconds.

The roast and bake ovens will indicate selection by displaying the setting and the letter 'A' in the display window. After 30 seconds only the letter 'A' will be displayed until the event time is reached. During an event period the desired setting will be displayed in the window and the relevant oven symbol will blink until the desired temperature is reached.

When the simmering oven is selected the symbol will blink to indicate selection and will continue to blink until an event period as started and the temperature reached.

To cancel AUTO mode press 'M' button  to return to manual mode or press on/off button  to turn OFF all zones (Ovens & Hob).

## **AUTO/Slumber** (ovens only)

This mode setting brings selected ovens up to full heat from Slumber.

The ovens can be selected to operate once or twice each day.

Each operation is termed an 'event', the start and finish time is chosen by you unless you use the pre-set time.

Press on/off button  to switch on the power to the appliance.

Press 'A'  then press and hold the 'A' button for 3 seconds.

Select ovens for automatic slumber operation, by pressing the appropriate buttons. 

The 3 oven symbols will illuminate  and blink until at the desired temp (slumber).

The 'A' button  will blink continually while in Auto slumber mode.

Select the desired cook setting by using the arrow symbols. Press the desired button, a red selection bar will appear under the relevant window to indicate the setting can be changed.

Use the UP  or DOWN  arrows to change the setting. The red selection bar will remain active for 30 seconds.

The roast and bake ovens will indicate selection by displaying the setting and the letters 'AS' in the display window. After 30 seconds only the letter 'AS' will be displayed until the event time is reached. During an event period the desired setting will be displayed in the window and the relevant oven symbol will blink until the desired temperature is reached.

## **NOTE:**



During Auto-Slumber mode the simmering oven is not affected by event periods and can be switched ON or OFF at any time.

## **PLEASE NOTE:-**

- Don't forget to include time for warm-up.
- Don't forget if you have set the AUTO/Slumber programme and have selected the AUTO/Slumber mode, an oven or ovens must be selected.
- The hotplates can only be operated manually.
- All the selected ovens will remain at 'Slumber' between 'events'.
- The last 'AUTO/Slumber' oven selection is remembered and re-called when 'AUTO' is next selected.
- **DO NOT OPERATE WITH THE APPLIANCE DOORS OPEN.**

## **AUTO and AUTO/Slumber**

Changing between any of the four operating modes, will cause the hotplates to switch OFF if in use - this is a built-in safety factor. They can be switched back on after the mode change if required.

To cancel AUTO/SLUMBER mode press 'M' button  to return to manual mode or press on/off button  to turn OFF all zones (Ovens & Hob).

## Cooking on your AGA eR7

The Aga eR7 is designed to give you flexibility when cooking a range of dishes through the four settings in the baking oven and the five settings in the roasting oven, as well as the long slow cooking in the simmering oven.

When referencing recipes from cookbooks, the eR7 pre-set cook settings are equivalent to the gas mark number.

The guide below gives an indication of the settings to use for specific foods, but the degree of cooking is often down to personal taste and you will soon find the settings which suit you. Happy cooking!

eR7 Pre-set oven settings	Description	Equivalent cooking Temperature °C	Equivalent Fan Oven Temperature °C	Typical Food Type
Simmering / Slumber	Very low	110 - 120	90 - 100	Very slow drying of meringues Slow cooking of stews, casseroles, meats, vegetables and poaching fruit. Food must be brought to temperature before placing in the simmering oven with the exception of meringues.
B1	Cool	140	120	Slow braised meat eg salt beef. Very rich fruit cake, pavlova.
B2	Slow	150	130	Slow roast eg. pork belly, ribs, gammon, lamb. Simnel cake, finishing lemon meringue, rice pudding, shortbread, cherry cake, custards eg crème caramel
B3	Moderately low	160	140	Curry, casseroles, stews, gammon, slow cooked meat, suet puddings eg steak and kidney, chilli. Cherry cake, Madeira cake, light fruit cake and cheesecake.
B4	Moderate	180	160	Tray bakes, sandwich cakes, small cakes, flapjacks, biscuits, bread and butter pudding, roulade
R6	Hot	200	180	Pastry, pizza, garlic bread, gratin, baked fish, baked chicken, toad in the hole, roasting meat, browning potato toppings on pies, moussaka, lasagne, baked vegetables eg dauphinoise potatoes, roasting nuts, finishing pasta bakes and soufflé. Fairy cakes, swiss roll, muffins, crumble.
R7	Hot	220	200	Bread, choux, roasting meat, soufflé, fish cakes, crackling, puff pastry pies and tarts, roasted vegetables and potatoes, baked potatoes, browning potato toppings on pies. Blind baking pastry, fruit pies, scones, quiche.
R8	Very hot	230	210	Roasted Mediterranean vegetables, potatoes. Fast roasting meat and poultry. Pizza and grilling
R9	Very hot	240	220	Fast grilling

## Oven venting

The AGA eR7's ovens are vented through the shroud located on top of the AGA between the two hotplates unless the AGA powered vent kit has been fitted. The venting system is designed for venting the moisture from the ovens.

It is recommended to install a cooker hood above the AGA eR7 if the AGA powered vent kit is not fitted. The cooker hood should be positioned not less than the minimum height as recommended by the manufacturer from the top of the AGA.

If a powered vent kit is fitted to your cooker, it should be used as follows:-

As each oven is vented to the outside, operation of the fan when food is placed in the oven means cooking smells and steam are directed to the outside rather than being evacuated into the kitchen. Turn on the vent fan by pressing the small AGA logo on the control panel when food is placed into the ovens. The venting of the oven also means that you can cook sweet and savoury items together without danger of mixing flavours - a delicate lemon sponge can be cooked in the same oven as garlic mushrooms!

### **REMEMBER TO SWITCH THE FAN OFF WHEN YOU HAVE FINISHED COOKING.**

The AGA eR7 ovens are manufactured from cast iron, over a period of time they will become individually seasoned.

The ovens are coated with **ALTRASHELL™** protective coating however, the ovens may rust if high moisture content foods are not covered (especially in the simmering/slow cooking oven) or spillages are not cleaned up.

It is also not advisable to leave a full or partially filled saucepan/utensils with high moisture content food in the ovens when they are not in use.

To season the ovens a light vegetable oil is ideal, spray oil is recommended. Any stubborn stains can be removed with the wire brush supplied.

Please refer to **“Caring and cleaning” page 44**, for Cleaning of Ovens.

## General advice

Food **SHOULD NOT** be placed into any oven until it is up to normal operating heat i.e. the green light of the selected oven is solid and not flashing.

The oven doors should not be left open for long periods of time during cooking and heating up.

### Warm up times

When a zone is heating up it will be indicated by a blinking red light on the control panel. When a zone has reached temperature a solid red light will indicate it has warmed up. AGA recommends that to fully saturate the castings it is best to leave them for one hour for the optimum cooking results.

### Boiling Plate

The boiling plate takes approximately 11 minutes to reach temperature from cold.

### Simmering Plate

The simmering plate takes approximately 8 minutes to reach temperature from cold.

### Roasting Oven

The roasting oven takes approximately 35 minutes to reach R8 from cold, and approximately 15 minutes to reach temperature from 'Slumber'.

### Baking Oven

The baking oven takes approximately 22 minutes to reach B4 from cold, and approximately 15 minutes to reach temperature from 'Slumber'.

### Simmering Oven

The simmering oven takes approximately 45 minutes to reach temperature from cold.

**PLEASE NOTE:** For optimum cooking performance, after the temperature has been reached, we recommend leaving for another 30 minutes for the castings to become heat saturated, particularly relevant if you are cooking a large meal or baking.

**PLEASE NOTE:** The times are based on each zone being operated individually. If a large combination of zones are turned on simultaneously, it may slow down the individual warm up times. If all zones are turned on at the same time it will take approximately one hour for the whole appliance to reach operating temperature.

These times are based on the cooker having a single phase supply of 32 amps @ 230 V. For other power supply configurations, these times may change.

## Handset - A hand held control

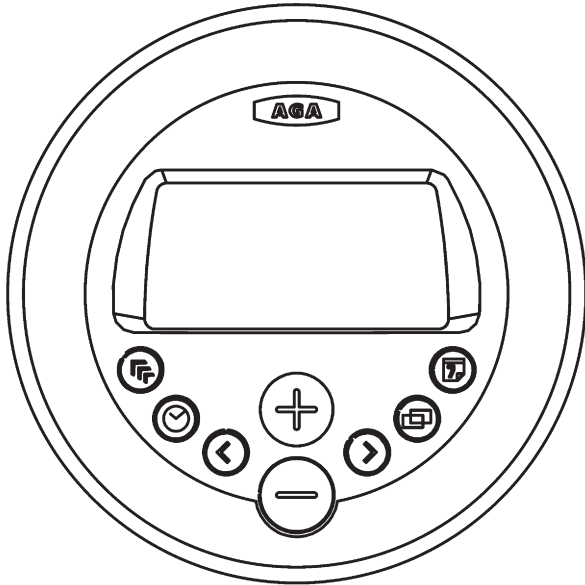

The handset displays the time, date and events. Programming uses eight push buttons. The information is displayed using a back-lit LCD screen.

### Screens

The handset has 3 main screens.

The display will revert to 'sleep' mode after approximately 3 minutes. Simply press the required button to open up any screen.

1. Information Home screen (main menu)
2. Date/Time screen
3. Events Programming screen

### Button operations

1.  **Communication or 'Handshake' button** used initially to synchronise the handset to the AGA eR7.
2.  **Clock button** Opens and closes the date and time settings screen.
3.  **Left/Back Button** Moves back and highlights the previous setting.
4.  **Plus Button** Increases the highlighted setting.
5.  **Minus Button** Decreases the highlighted setting.
6.  **Right/Forward Button** Moves forward and highlights the next setting.
7.  **Copy Button** Copies the time programme from the current day to the following day in the 7-day event calendar screen.
8.  **7-day event Button** Opens and closes the 7-day event calendar screen.



## Handset advice

### Operating distance

The handset will only operate in the same room as the cooker and up to a maximum distance of 4 metres from the appliance. If out of recommended operating range, the handset may show 'Standby'. If this happens move the handset back to within the recommended distance and it should correct itself, see below.

### Handset to AGA eR7 Signal Check

The  (Standby) symbol is shown when in the following situations;

1. Standby mode
2. Communications fail
3. A power cut
4. Handset is out of range of the AGA eR7 cooker

When transferring information from or to the controller always operate the handset in front of the cooker, this gives the strongest signal.





If the handset shows  Standby, when the cooker is on, press the  button firmly for 1 second, this will activate the communication link between the cooker and handset.

### Communication/Handshake

For details on initial Communication/Handshake, see **"Communication/handshake" page 25.**

### Preview Mode

If the handset is out of range of the cooker or if the appliance is switched off, Preview only mode is available. Changes cannot be made to the programmed events. The  symbol is displayed in the screen and the message 'Preview only' is displayed briefly when the events programme screen is first entered.

When in Preview Mode you can review the days by using the  and  buttons. The  and  buttons become inactive and you cannot make any changes.

### Handset Failure

In the unlikely event of handset failure, the appliance would still be operational with the last selected programme. The cooker can also be changed to Manual mode from one of the auto modes using the mode button on the control panel. If the handset is damaged or lost, a replacement can be obtained from AGA and re-programmed to suit your appliance.

**DO NOT PLACE THE HANDSET ON ANY HOT SURFACES.**

## Communication/handshake

This process will be required on the original installation of the AGA eR7. If the handset is replaced for any reason the new handset will need to be synchronised.

- You will also need to set the time and date.
- You will also be given the option to set your own Auto programme preferences.

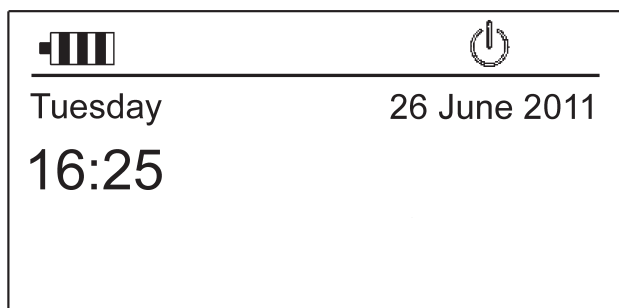

### Step 1



Handshake can be activated 30 seconds after mains power has been applied to the cooker. The Standby button on the touch panel must be 'ON'. It must then be completed within 2 minutes, otherwise you will need to repeat the process.

### Step 2

Press and hold  button on the handset for 10 seconds to open the communicate/synchronise screen. The following screen message then appears.

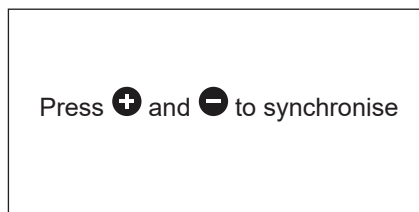
### Step 3



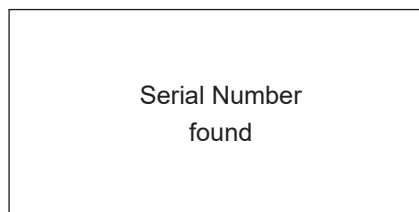

Simultaneously press the  and  buttons, the serial number will be 'found' by the handset.

The following screen message then appears briefly.



#### Step 4

Use the  and  buttons to choose the language you want the handset text to be in, then press  to confirm the language choice required.

Once time and date has been set the Auto/Event programme screen will appear.



#### Step 5

Set the correct time and date see **“The date/time setting screen” page 27**.

#### Step 6

You have the option to set your own Auto programme at this stage, see **“The date/time setting screen” page 27**. If you wish to leave until later, then press  it will remain at the pre-set times: 1 Event 7am - 7pm (7 days).

#### Notes

-  Symbol appears in the top right hand corner of the screen, if the handset is out of range with the cooker or the communication/handshake process has not been completed. When communication is OK then  symbol is displayed.
- The  button can be used to force communication between the cooker and the handset. This function is active once successful initial communication has been made, and the handset is in range.

## The date/time setting screen

Press and hold Clock button  until the screen is displayed.

In this screen the time, date, month and year can be altered/set.

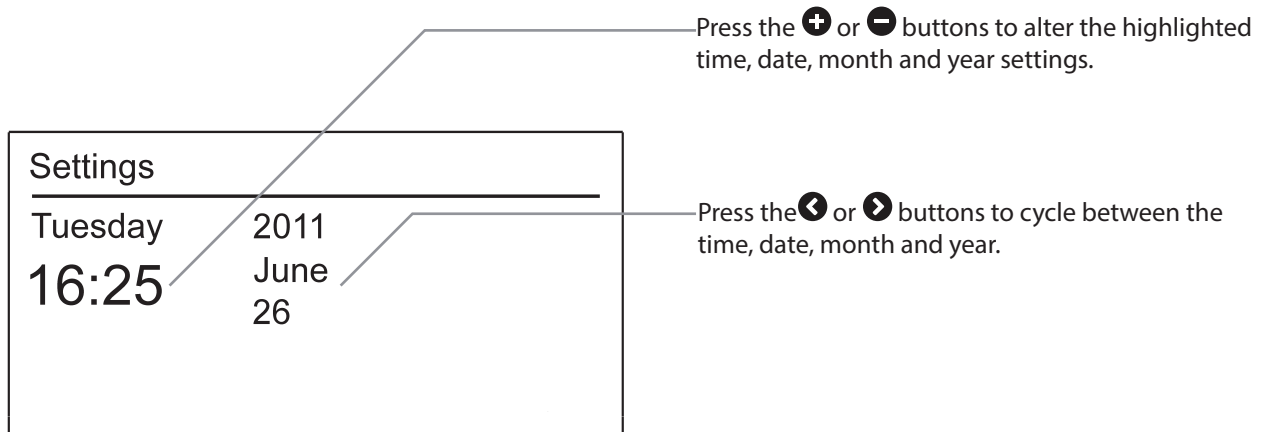

Press  button at any stage to save the settings and exit the DATE/TIME screen.

**'Message sent OK'** will appear on the screen when the handset is in range of the cooker.

**'Changes stored on handset only'** will appear on the screen, when the controller handset is out of range of the cooker.

### Notes

- Even if no changes are made to the time, date, month and year settings, a press of the clock button  is still required, to return to the Home screen.
- The day cannot be changed as the handset automatically knows this information, when the date and year is set.
- The Home screen will automatically appear after the replacement of new batteries.

## Auto/events programme screen

This screen is opened by pressing the 7-day event button .

In this screen, the number of events and the start and end time of events can be set. Each day can have a different number of events, and start and end times, or all seven days can be the same.

There are pre-set times already programmed, to change to your desired settings follow these instructions. Pre-set times are 1 event 7am - 7pm (7 days).

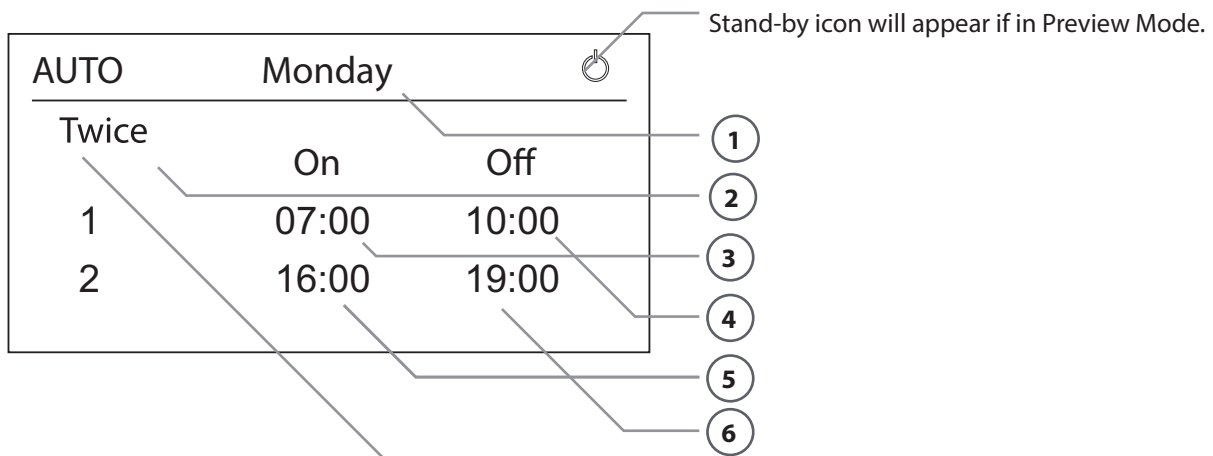













'Twice' will be shown if two events are set.





'Once' will be shown if one event is set.

'No' will be shown if no events are set.

### What you can do



1. The current day is shown on the display, this can be changed to the day that you wish to edit by pressing the  and  buttons.
2. This shows the number of events in that day. This can be changed from no, once or twice by pressing the  and  buttons.
3. This shows the start time of the first event. This can be changed by pressing the  and  buttons.
4. This shows the end time of the first event. This can be changed by pressing the  and  buttons.
5. This shows the start time of the second event. This can be changed by pressing the  and  buttons.
6. This shows the end time of the second event. This can be changed by pressing the  and  buttons.

### How you do it

Press the  or  buttons to navigate through the settings on the screen. When a setting is selected it will be highlighted by a dark box. Pressing the  and  buttons. will change the information in this highlighted box.

Press  to copy program settings to next day.

If you have made changes and wish to exit this screen, press the  button. A 'Save Changes' - Yes or No? message will appear on the screen.

Pressing the  and  buttons will highlight Yes or No. Press the  button again to confirm your choice.

**REMEMBER:** After setting the Auto event that an oven selection must be chosen on the touch panel  if you wish to activate the programme you have just entered.

### Notes

- Even if no changes are made a press of the  button is still required, to return to the Home screen.



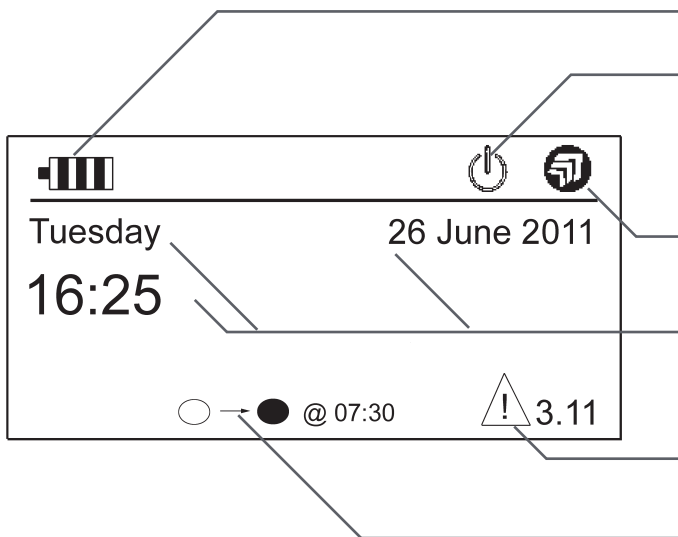

## Information (home) screen

This is the main screen, where information such as time, date, battery life and connectivity is displayed. If you have programmed either of the 'AUTO' modes and they are currently in progress, the next change of event will also be displayed. The information below explains this in more detail.

Press any button on the handset to open this screen, from 'Sleep' mode.



## Change of event symbols

-  **AUTO event on**  
(before AUTO event)
-  **AUTO event OFF**  
(during AUTO event)
-  **AUTO/Slumber event ON**  
(before AUTO/Slumber event)
-  **AUTO/Slumber event OFF**  
(during AUTO/Slumber event)

Symbol indicating the battery life.

If there is no communication between the AGA eR7 and the handset because: the cooker is not powered, in standby or the handset is out of range from the cooker. The  symbol is displayed.

Communication/Handshake symbol indicates communication between the cooker and handset is OK.

Symbols indicating the current time and day.

Warning triangle and error code is displayed if an error occurs.

If either AUTO or AUTO/Slumber mode is active the next event change will be displayed for that day with the relevant symbols to show start and end times.

**NOTE:** If standby icon is shown then event indicator will not be displayed.



### **Power cuts under 10 minutes**

When the power is restored, the AGA eR7 will resume normal operation as was set prior to the power interruption.

### **Power cuts over 10 minutes**

Most functions will have turned OFF.

- 'Manual' mode - all zones OFF.
- 'Slumber' mode - hotplates OFF, Slumber ON
- 'AUTO' mode - hotplates OFF, ovens continue with the set programme.
- 'AUTO/Slumber' - hotplates OFF, ovens continue with the set programme.

A 'Power Cut' message may appear on the handset screen, confirm by pressing any button on the handset. Therefore the cooker may not be at temperature when expected.

### **Automatic update of time**

In the event of power cuts the handset will automatically update the controls within the cooker to the correct time on restoration of power. This is provided that the following criteria are met:

1. The handset is sited within range of the cooker
2. The handset has good batteries
3. The handset contains the correct time itself

**PLEASE NOTE:** The handset time will need to be updated with Spring and Autumn time changes B.S.T / G.M.T. See "**The date/time setting screen**" page 27.

## Batteries

The handset is fitted with four 'AAA' batteries, which are packed separately. Your Engineer will insert them when your AGA eR7 cooker is installed. When replacing the batteries, follow these instructions in conjunction with the diagrams. Remove the handset from its backplate, then remove the battery cover plate from the rear of the handset (Fig. 1).

Carefully lever out the batteries commencing with the bottom one first pushing and pulling out on the **positive (+) end only** (Fig. 2). Repeat this procedure to remove the other batteries.

**Always** use long life batteries for replacements - rechargeable batteries are not recommended.

Replace the batteries commencing with the bottom one working to the top (Fig. 3).

Battery life will depend on usage. Replace the batteries when the battery symbol on the handset is down to one bar.

### Care and cleaning

The handset should be wiped clean using a soft clean cloth. **DO NOT** use abrasive cleaning products or submerge the handset in water.

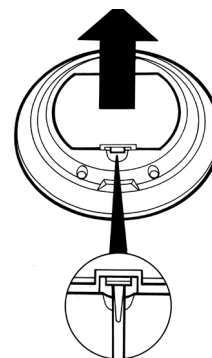

fig. 1

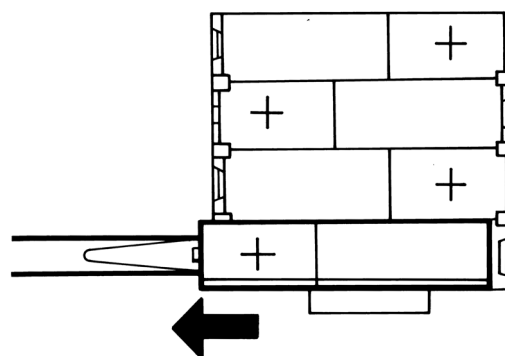

fig. 2

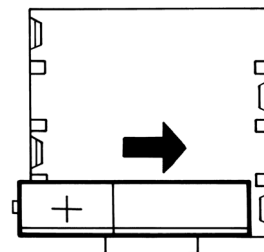

fig. 3

## Using the zones of the AGA eR7

### The hotplates

The hotplates are operated manually, make sure the standby button is on then just press the touch control panel of the hotplate you need and a flashing red light will appear, when the hotplate reaches its full preset heat it will become solid red.

The boiling plate is on the left hand side and the simmering plate is on the right hand side of the AGA eR7. The boiling plate is the hottest with the simmering plate being the cooler of the two. They both have electric elements embedded into the cast iron which heat up in approximately 11 and 8 minutes respectively. The hotplates can be used completely independently from the ovens.

This means the AGA eR7 differs from the classic AGA heat storage cooker in that they can be used for the entire cooking time of appropriate dishes because the design keeps the hotplates at a constant heat, whereas the classic AGA cooker continues to cook on a falling heat so for these we recommend starting on the hotplate(s) then transferring to the ovens, this can be done with the AGA eR7 but is not necessary. For instance, if making a pasta dish with sauce on the AGA eR7, it can all be done on the hotplates.

The whole hotplate area can be used for cooking and several pans can be accommodated on a single plate at any one time. The hotplates are set very slightly above the top plate to avoid accidental scratching if the pans are pulled to one side. **DO NOT** drag the utensils from one plate to another as the enamel will suffer!

The stainless steel insulated covers are brought down over the hotplates when they are not in use. When the hotplates are 'on' the insulated covers will be warm. We **strongly advise** not to put anything such as kettles, saucepans or baking tins directly onto the insulated covers because they will show any scratches – invest in a pair of chef's pads to protect the surface if the covers are to be used as resting places!

Keep the hotplates clear of any burnt on food or crumbs by brushing with the wire brush, supplied with your AGA. Cleaning details can be found on **“Caring and cleaning” page 44.**

## The boiling plate

The hottest hotplate, the boiling plate is used for boiling, frying, griddling, stir-frying, making toast - indeed anything that requires a high heat. Green vegetables keep their colour when boiled quickly here, or use a steamer over the saucepan to cook more than one vegetable at once.

When stir frying or cooking anything that is inclined to splash we would recommend using an AGA Splash Shield which will protect the insulated cover from splatter, making cleaning a doddle! Just wash the Splash Shield in hot soapy water or place in a dishwasher between two dinner plates.

Please be advised the boiling plate is too hot to cook food direct on it.

## The simmering plate

The simmering plate is the cooler of the two hotplates and so is used for recipes that require a lower heat such as, making sauces, scrambling eggs, heating milk, slow frying, simmering soups and root vegetables. In addition it can be used direct on as a form of griddle - invaluable for toasted sandwiches, quesadillas, drop scones, searing scallops and even a non-fat fried egg! Slow cooked toast can be made on the simmering plate, no need here to use the AGA toaster. bako-glide can be used to protect the hotplate surface when direct on cooking.

Both boiling plate and simmering plate are the same size. Both are machined flat to give the best all over contact with the AGA saucepans, grill pan, frying and kettle.

Cleaning details can be found on **“Caring and cleaning” page 44.**

## The top plate

The top plate is the enamelled surface surrounding the hotplates. It will become warm when the AGA Total Control hotplates are in use. Although it is not a cooking surface you can use the warmth for a number of useful activities, which more often than not saves time and washing-up! These include warming honey or syrup in the jar, or melting butter or chocolate in a basin - so saving on melting over a saucepan - do please put the basin on a cork mat or folded piece of kitchen towel to avoid scratching the enamel. Although it is a durable and hard-wearing surface vitreous enamel is glass and will show scratch marks!

The top plate when warm can also be used to rest a cup of coffee or tea or dry off awkwardly shaped tins, peelers or food mixer and processor parts.

## The ovens

**The roasting oven** for high temperature cooking. Offering a range of cook settings B4, R6, R7, R8, and R9.

**The baking oven** for moderate temperature cooking. Offering a range of cook settings B1, B2, B3, and B4.

**The simmering oven** for long, slow cooking. Fixed at simmering temperature.

**DO NOT OPERATE THIS APPLIANCE WITH THE DOORS OPEN, SINCE THIS CAN CAUSE A LOCK-OUT.**

Each oven has the same capacity, (able to fit a 13kg (28lb) turkey) and the classic AGA heat-storage cooker techniques can be used such as stacking of saucepans in the simmering oven. This enables the steaming of root vegetables, rice, steamed pudding, casserole, poaching fruit all in the same oven leaving the hotplates free.

You can have one, two or all three ovens on at their pre-set heat or the roasting and baking ovens can also be at 'Slumber' mode, (the simmering oven is always at the same heat).

The ovens are made from cast iron, which cooks by a radiant heat and this is the secret of the cooking excellence for which the AGA cooker is renowned. An indirect radiant heat does not dry food out, so it retains its natural moisture and flavour.

## **Slumber mode**

In Slumber mode, all three ovens operate like a simmering oven.

The simmering oven is always in Slumber, whereas the roasting and baking oven can be set on Slumber mode for either cooking at a low heat, or to generate gentle warmth into the kitchen, or in readiness for turning up to their normal pre-set heat.

Cooking at Slumber in the roasting or baking ovens gives the best results for making large rich fruit cakes and meringues as they benefit from the gentle heat up of top and base elements to ensure thorough cooking. Other foods which benefit from cooking at Slumber in these ovens are steamed and Christmas Puddings and slow cooking large joints of meat - start the cooking process before placing the oven on Slumber.

## The roasting oven



The roasting oven is indirectly heated by two elements, one in the base of the oven and the other in the roof. These elements heat the air and the cast iron within to provide cooking results consistent with the classic AGA heat-storage cooker, with the flexibility of being able to turn it to change the cooking temperature.

The roasting oven can be used for 'grilling' at the top and 'shallow frying' on the oven floor, see **"Cooking on your AGA eR7" page 20.**

When cooking on the floor of the roasting oven for long periods of time (more than 30 minutes), place the floor grid on the floor of the oven before putting the food into the oven, this lifts the food away from the base element to ensure best cooking results are achieved.

### A note when cooking on the floor of the roasting oven.....

- Please leave 1 hour before cooking directly on the floor of the oven, this is to ensure maximum temperature stabilisation of the base element.
- You can cook directly on the floor of the roasting oven for short periods of time e.g. pizza, quiche, or foods that take 30 minutes or less.

**NOTE:** The roasting oven perforated baffle should be positioned in the top of the roasting oven in order to optimise cooking performance. It must be in place at all times, while the cooker is in operation, including when grilling. (See diagram for fitment of roasting oven perforated baffle).

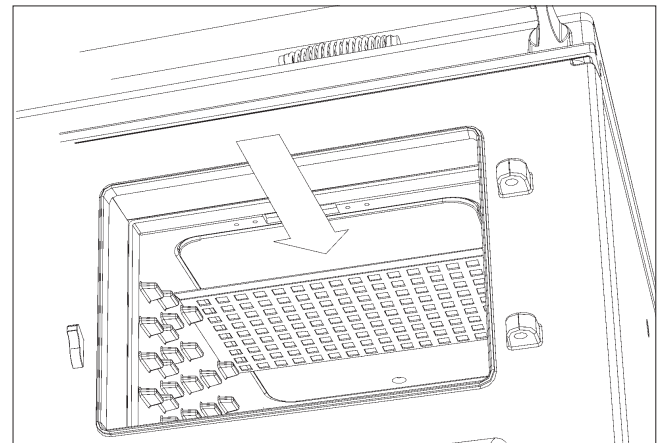

The roasting oven is zoned in heat, meaning it is slightly hotter towards the top than the centre and the oven grid shelf set on the oven floor is slightly less hot than the centre.

The floor of the oven can be used as another cooking surface, indeed it is often called a hidden hotplate - for food needing longer than 30 minutes, such as roast potatoes, on the floor of the oven you will need to use the floor grid for protection, so they do not over brown.

The beauty of the roasting oven is that any fat splashes are burnt off when the oven is at full heat, just brush out occasionally to get rid of carbon deposits.

The roasting oven is excellent for bread and pastries. Quiches in ceramic or pies in Pyrex dishes need not be baked blind as when they are placed on the floor of the oven the pastry cooks from underneath and the filling will set and brown from the all-round heat. As you are aware metal flan tins conduct heat quicker than ceramic so always place them on the floor grid placed on the floor of the oven to avoid over-base browning.

The specially designed roasting tins and bakeware slide directly onto the runners, so almost every available square centimetre of space can be used.

### **Roasting oven at slumber**

When the roasting oven is set at Slumber it can be used to cook rich fruit cakes or slow cook roasts, casseroles and curries. With the exception of meringues and rich fruit cakes, food that is to be slow cooked should be brought up to heat before placing in an oven at Slumber. The light will flash when heating up to Slumber, then go solid when up to temperature.



## The baking oven



The baking oven is indirectly heated by two elements, one in the base of the oven and the other in the roof. These elements heat the air and the cast iron within to provide cooking results consistent with classic AGA heat-storage cookers, with the flexibility of being able to turn it to change the cooking temperature.

This oven is set at a moderate heat, so is ideal for cakes, biscuits; also anything that requires medium heat cooking such as fish pie, lasagne, soufflés, crumble and roulades. Meat and poultry can be cooked here indeed most things that can be cooked in the roasting oven can be cooked in the baking oven but for a longer time, see **“Cooking on your AGA eR7” page 20.**

For the best results when cooking cakes do allow an hour heat up time. Cook cakes together on one shelf if two shelves are used interchange the food to achieve even colouration, as you would with any oven which is zoned in heat.

As with the roasting oven the specially designed roasting tins and bakeware slide directly onto the runners, so almost every available square centimetre of space can be used.

### **Baking Oven at Slumber**

When the baking oven is set at Slumber it can be used to cook rich fruit cakes or slow cook roasts, casseroles and curries.

With the exception of meringues and rich fruit cakes, food that is to be slow cooked should be brought up to heat before placing in an oven at Slumber. The light will flash when heating up to Slumber, then go solid when up to temperature.

## The simmering oven



The simmering oven is indirectly heated by one element in the base of the oven.

This element heats the air and the cast iron within to provide cooking results consistent with the traditional simmering oven of the classic AGA heat-storage cooker, with the flexibility of being able to turn it to Off when not required. The simmering oven is always at a simmer or Slumber mode ideal for long slow cooking.

The floor grid is used here to protect items placed on the floor of the oven such as vegetables for steaming, keeping sauces warm or casseroles cooked for a long time. Always ensure this is in place, before putting food into the oven.

The simmering oven can be described as a continuation oven, it continues to cook food that has been brought up to heat elsewhere on the cooker with the exception of meringues which are dried out rather than 'cooked'.

## The simmering oven

### User Guidance

- Allow the oven to heat up fully, the longer the oven is on the better, since this helps reduce the amount of moisture created during simmering.
- To get the very best performance, we recommend to use AGA cookware with thick bases and stacking lids.
- **DO NOT** place dishes directly on to the oven base. Always place onto either a shelf or the floor grid.
- Joints of meat and poultry should be brought up to heat ideally in the Roasting oven for 30 - 45 minutes, before transferring to the Simmering oven.
- This method is unsuitable for stuffed meat and poultry.
- Make sure that pork and poultry reach an internal temperature of at least 75°C.
- Always bring soups, casseroles and liquids to the boil before putting in the simmering oven.
- Always thaw frozen food completely before cooking.
- Root vegetables will cook better if cut into small pieces.
- Adjust seasonings and thickenings at the end of the cooking time.
- Many dried pulses and beans for example, dried red kidney beans must be boiled for a minimum of 10 minutes, after soaking, and before inclusion in any dish.

**PLEASE NOTE: DO NOT** store anything in the simmering oven and **DO NOT** use large cookware such as the large baking tray and large meat tin until the oven has reached it's operating temperature. Failure to do this may cause the safety function to lock in the OFF position. It is also advisable when using large cookware in the simmering oven to push it to the back of the oven.

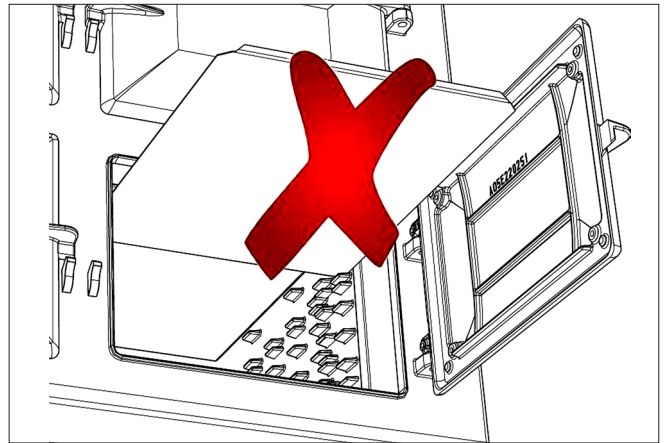

## AGA (Hotcupboard)

### Slow Cooking Oven plus Warming Oven

These ovens are heated by a single element at the rear of the oven cavity. It is operated by a single push ON-OFF button located on the left hand side of the hotcupboard top plate and can be turned ON and OFF when required. These ovens are not cast iron on the interior.

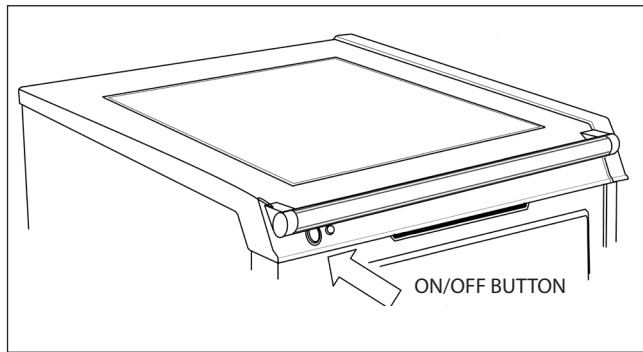

### Slow Cooking Oven

This oven has similar characteristics of the simmering oven and should be utilised in a similar manner. It delivers a gentler convected heat making it better suited for longer cooking times especially for overnight cooking, for example rich fruit cakes and celebration cakes. The cooking of meringues may also be better suited for this oven.

**NOTE:** These ovens vent into the room, mechanical venting to the outside is not available.

### Points to remember when Slow Cooking:

- Pre-heat the oven for 30 minutes before starting to cook.
- Bring casseroles, soups etc to the boil on the hob and start meat in the roasting oven, before placing in the slow cooking oven.
- Make sure that casseroles have sufficient liquid, particularly when cooking over a long period.
- Use lids on casseroles or foil to cover food whilst it is cooking to retain moisture.
- Make sure all dishes will fit into the oven before preparing food.
- Make sure that meat and poultry is piping hot before eating and reaches 75°C internal temperature.
- Always thaw frozen food completely before cooking.

You can also produce crisp, white meringues cooked in the slow cooking oven.

Timings for cooking in the slow cooking oven will depend upon the temperature, quantity and type of dish you are cooking, as a guide for casseroles, a minimum of 2 hours cooking time is recommended.

Keep an eye on the food until you are familiar with the oven.

The slow cooking oven can be described as a continuation oven. It continues to cook food that has been brought up to heat elsewhere on the cooker with the exception of meringues which are dried out rather than 'cooked'.

## Caring and cleaning

### REMEMBER: BE CAREFUL OF THE HOT APPLIANCE.

- **DO NOT** use a steam cleaner to clean this cooker.
- **DO NOT** use abrasive pads, caustic cleaners, oven cleaners or metal scrapers to clean the surfaces of the enamel.
- The touch control panel may be cleaned with a damp cloth and warm soapy water.
- **DO NOT** use any power sprays or oven cleaners on the control panel.

### Top Plate and Front Plate

The easiest way to clean the AGA top plate and front plate is to mop up spills as soon as they happen. It maybe useful to keep a damp cloth handy to do this. Baked-on food is more difficult to clean but can usually be removed with the AGA vitreous enamel cleaner or mild cream cleaners using a damp cloth, or, if necessary a nylon scouring pad. If milk or fruit juice or anything containing acid, is spilt on the cooker, wipe it up immediately. Also clean off any condensation streaks on the front plate around the oven doors or the vitreous enamel maybe permanently discoloured.

All that is usually needed to keep the vitreous enamel surfaces of the cooker bright and clean is a daily rub over with a damp soapy cloth followed immediately with a clean, dry cloth to avoid streaks. The AGA E-cloths are excellent for this.

Remember the top plate and the polished covers will scratch if pans or utensils are dragged across them.

### Insulating Covers and Oven Door Linings

The best way to keep the linings clean is to wipe them over after cooking so that splashes do not get baked on (being careful with a hot cooker). Clean the linings when they are cool, the cooker is off.

Linings of the Insulated Covers (lid interior) - the use of an AGA splash shield is recommended to keep the lining free of fat splashes (obtainable from your AGA Specialist or online at [www.agacookshop.co.uk](http://www.agacookshop.co.uk)). If the linings are marked these are best cleaned when the hotplates are cold. Linings can be cleaned with hot soapy water and / or a cream cleanser. If badly marked then a soapy soap-impregnated pad can be employed - this should be used in a circular motion. The first few times you use a soap-impregnated pad you will see the circular marks but these are reduced and the surface of the linings become shinier each time of use. **DO NOT** use excessive water and make sure the linings are dry before closing the covers.

Oven door linings - the linings can be cleaned with hot soapy water and / or a cream cleanser. To deep clean the linings, place a towel on the work surface and carefully lift off the oven door (doors are heavy) and place it enamel side down on the towel padding. Clean with a soapy impregnated pad to remove stubborn marks. **DO NOT** immerse the doors in water as they are packed with insulating material which will be damaged by excessive moisture. Needless to say, do not put oven doors in a dishwasher! Dry off before carefully replacing on their hinges.

The tops of the insulated covers (lids) - these are stainless steel and can be kept clean by wiping over with a damp cloth and polished up - the AGA E-cloths are excellent for this purpose as they are lint-free and eco-friendly. AGA Stainless Steel and Chrome Cleaner are recommended to keep the insulated covers clean and shining, which can be purchased from your local AGA Specialist.

**DO NOT IMMERSE THE DOORS IN WATER AS THEY ARE PACKED WITH INSULATING MATERIAL WHICH WILL BE DAMAGED BY EXCESSIVE MOISTURE.**

**DO NOT PUT OVEN DOORS IN A DISHWASHER.**

### **Ovens**

The cast iron ovens help to keep themselves clean, they merely need to be brushed out occasionally with the wire brush supplied.

The ovens are made from cast iron, and are very durable, but they will rust if surface moisture is left on them regularly. Remember to always switch the ovens on, to dry them out after cleaning. This is done by leaving them to heat up until the green light on the control panel turns solid.

Heating up of the ovens periodically, will help burn off any cooking deposits to aid cleaning within the ovens.

### **Hotplates**

The hotplates are easy to care for, and regular maintenance will ensure long-life. Should the hotplates become soiled, use a sponge, cloth, scouring pad or wire brush to remove burnt-on spills. Rinse off detergents or cleaning agents thoroughly.

Hotplates are made from cast iron, and are very durable, but they will rust if surface moisture is left on them regularly.

Remember to switch on the plates for a few minutes to dry them after cleaning. Every now and then, apply a thin coating of cooking oil when the hotplates are cold.

### **Roasting Tins**

The enamelled roasting tins supplied with the AGA Total Control should be cleaned in hot soapy water, soaking if necessary. A nylon scouring pad can also be used. They may also be cleaned in the dishwasher, but with constant use, the enamelled finish will become dull in appearance.

**DO NOT** use caustic cleaners or oven cleaners.

## **Important**

**We recommend Vitreous Enamel Association approved cleaners for cleaning the vitreous enamelled surfaces of this product.**

**They are unsuitable for use on: chrome and stainless steel components, including the insulating covers, hand-rails and their brackets.**

## Fitting of oven shelves

When using the oven shelves for the first time follow Figs. 4 - 7.

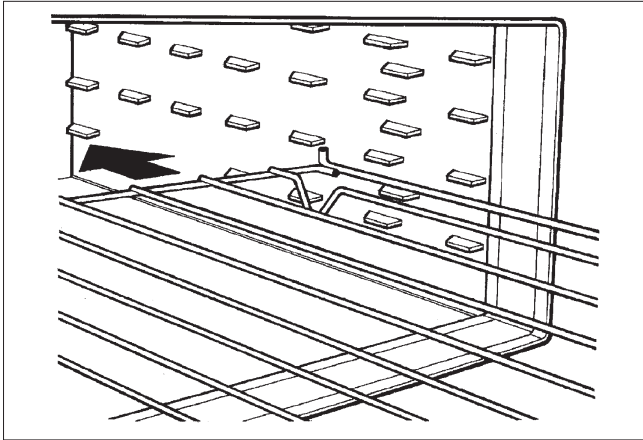

fig 4

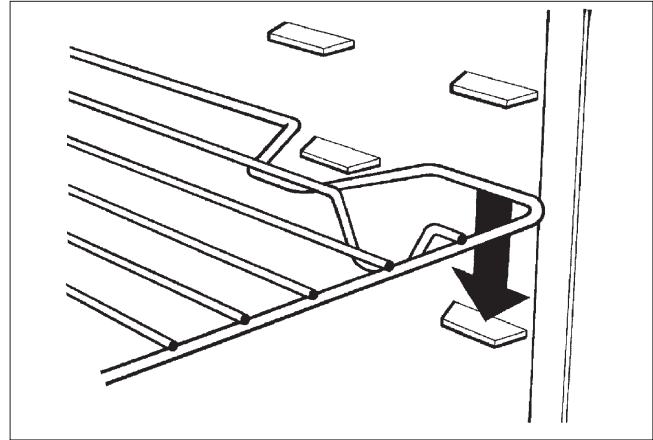

fig 5

## Removal of oven shelves

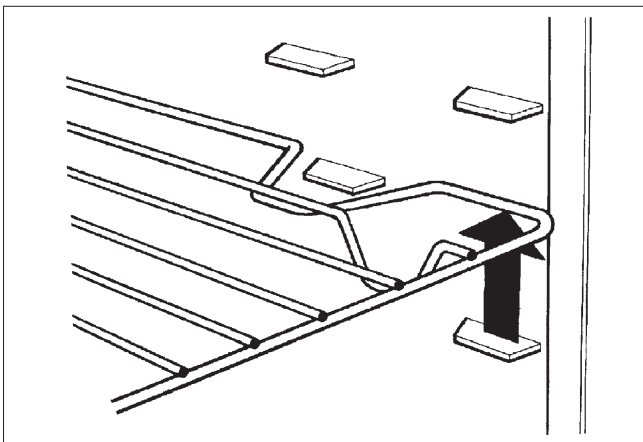

fig 6

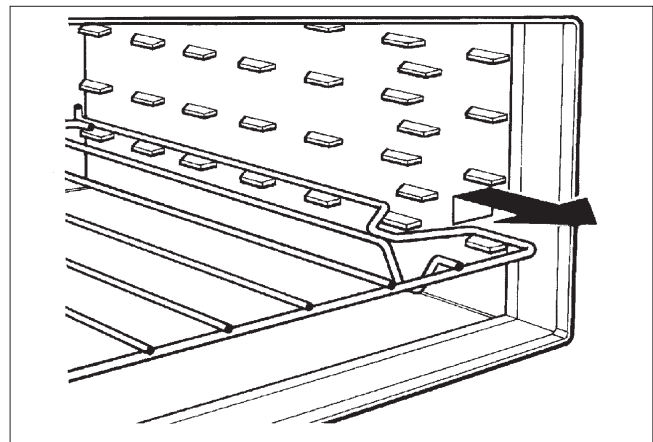

fig 7

## Servicing and warranty

- Your Aga does not need to be regularly serviced.
- Fans may need periodic replacement.
- In the event of requiring maintenance, please call AGA Service or your authorised distributor.
- Your appliance **MUST** only be maintained and installed by a qualified engineer, AGA engineer or an authorised distributor.
- **DO NOT** alter or modify the appliance.

The appliance warranty does not cover Commercial use (see separate Warranty book provided for further details).

## Error codes

In the unlikely event an error occurs with your AGA eR7 cooker, error codes may be displayed on your handset, for example:

### 3.11

Please provide AGA Service with this information. It will assist the service engineer with diagnosing your fault.

## Serial number

Make a note of your AGA eR7 Serial Number when it is being installed. The serial number can be found behind the magnetic plinth cover.

## Health & safety

### Consumer Protection

As a responsible manufacturer, we take care to make sure that our products are designed and constructed to meet the required safety standards when properly installed and used.

 **This appliance is not intended for use by persons (including children) with reduced physical, sensory or mental capabilities, or lack of experience and knowledge, unless they have been given supervision or instruction concerning use of the appliance by a person responsible for their safety.**

 **Children should be supervised to ensure that they do not play with the appliance.**

 **IMPORTANT NOTICE: PLEASE READ THE ACCOMPANYING WARRANTY**

 **Any alteration that is not approved by AGA could invalidate the approval of the appliance, operation of the warranty and could also affect your statutory rights.**

### APPLIANCE

 **YOUNG CHILDREN SHOULD BE KEPT AWAY FROM THE APPLIANCE AS SURFACES CAN BECOME HOT TO TOUCH.**



## Deep fat frying

### IMPORTANT

- Use a deep pan.
- Never fill the pan more than one-third full of fat or oil.
- Never use a lid on the pan.
- Important: Oil is a fire risk, do not leave pans containing oil unattended.
- In the event of a fire, cover the pan with a lid and turn OFF the appliance.

Smother the flames on the hob preferably with a fire blanket, rather than attempting to remove the pan to the outside.

Burns and injuries are caused almost invariably by picking up the burning pan to carry it outside.

- **DO NOT** hang clothes on the left hand side of the AGA hand-rail. The electrical controls are behind the top left hand door, blocking the air vent can cause excessive control temperatures, and will prevent easy access to the controls.

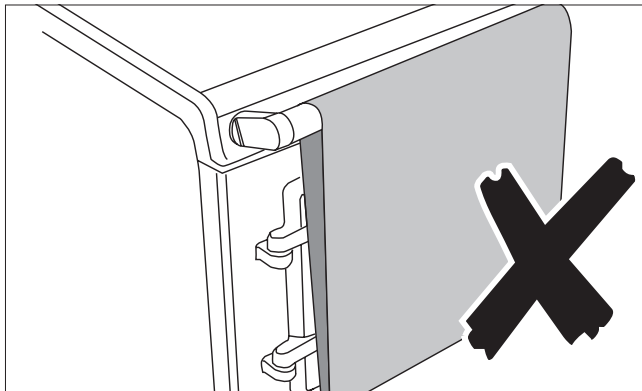

**⚠** When the oven(s) are on **DO NOT** leave any oven door open for long periods, this will affect the temperature of the oven and may allow controls to become hot.

**⚠** A little smoke and some odour may be emitted when the appliance is first switched on. This is normal and harmless (from oven lagging and starch binder on the element insulation) and will cease after a short period of use.

## **AGA basic recipes**

These are some fundamental recipes and methods to compliment your first AGA cooking ventures. The real basics to get you started and used to using your AGA eR7 cooker. Relax, enjoy and then try some of our ideas in the Recipe section of this handbook.

### **AGA Toast**

AGA toast is renowned for its excellence, crisp on the outside and soft in the centre. Take thick slices of bread and place in the AGA toaster – if the bread is very moist or very fresh, heat the toaster beforehand to prevent sticking – lift the boiling plate insulated cover and place the toaster direct onto the plate with the handle at an angle from the handle of the cover. Close the cover and wait for the bread to toast one side – this will take 1-2 minutes dependent upon the variety of bread – open the cover and turn the toaster over and repeat the process to toast the other side.

Serve piping hot with butter and marmalade. A great start to the day!

### **Steaming Vegetables**

Steaming of root vegetables can take place either on the hotplates using a steamer over an AGA saucepan, alternatively if you have the simmering oven, (or any oven at Slumber), switched on then you can oven steam the root vegetables. Oven steaming means saucepans of root vegetables can be started on the hotplates, using a small amount of water, brought to the boil for 3-5 minutes, the water drained and the saucepan lid replaced. Put on the floor grid in the simmering oven for 20 -30 minutes until tender. 6-8 saucepans can be accommodated in the simmering oven, leaving the hotplates free for 6 more!

Green vegetables benefit from quick boiling on the boiling plate to keep their vibrant colour, or you can steam them over boiling water.

## **Boiling a kettle**

When the boiling plate is switched on then it's time for tea! The AGA kettles are especially designed for maximum performance on your cast iron hotplates, the kettle will boil quickly on the hot boiling plate - if you have just turned on the boiling plate obviously it will take longer to boil! Always use fresh water, just enough in the kettle for your requirements and it's a good habit to always leave the kettle empty to minimise the build up of limescale.

Place the kettle onto the boiling plate, giving it a slight twist as you do so to ensure a perfect contact. Also check the hotplates are clear of any burnt on spills or crumbs - just brush over the cast iron with the wire brush, supplied with your new AGA eR7. Pointing the spout towards the lid lining will help keep it clean, as the steam can loosen splashes. Give the lining a quick wipe over after removing the kettle.



## **AGA CLOUD, THE FIRST AGA RECIPE APP**

Download **AGA Cloud** to view a host of delicious step-by-step recipes tailored to your AGA appliance.

*Available only in the United Kingdom and Ireland.*



With AGA Rangemaster's policy of continuous product improvement, the Company reserves the right to change specifications and make modifications to the appliances described and illustrated at any time.



Manufactured By  
AGA Rangemaster  
Station Road  
Ketley Telford  
Shropshire TF1 5AQ  
England

[www.agaliving.com](http://www.agaliving.com)  
[www.agacookshop.co.uk](http://www.agacookshop.co.uk)

CE  
UK  
CA

