

# Television

## Téléviseur

### Televisor digital a color con pantalla de diodo orgánico de emisión de luz (OLED)

### Reference Guide

### Manuel de référence

### Guía de referencia

K-65XR80M2 / 65XR80CM2  
K-55XR80M2 / 55XR80CM2

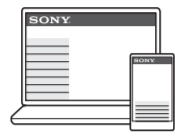
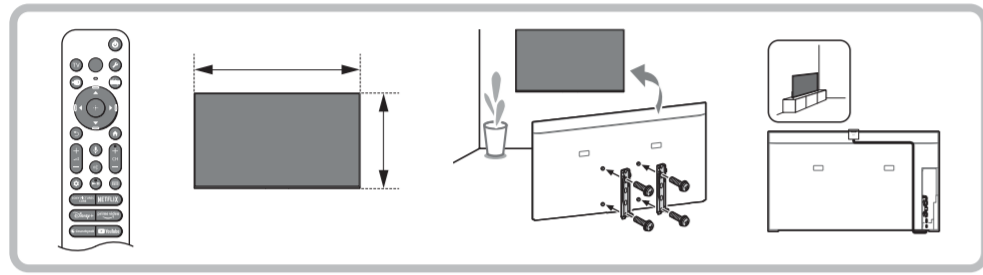

[https://rd1.sony.net/help/tv/musltr1/h\\_usltrn/](https://rd1.sony.net/help/tv/musltr1/h_usltrn/)

Read this manual before using this product

Lisez ce manuel avant d'utiliser le produit

Lea este manual antes de usar el producto

### Sony Customer Support

U.S.A.: <https://www.sony.com/tvsupport>  
Canada: <https://www.sony.ca/support>  
U.S.A. Canada 1.800.222.SONY (7669) 1.877.899.SONY (7669)  
Call the telephone number that appears on your warranty card policy. Please do not return the product to the store.

### Service à la clientèle Sony

Canada : <https://www.sony.ca/support>  
États-Unis : <https://www.sony.com/tvsupport>  
Canada États-Unis 1.877.899.SONY (7669) 1.800.222.SONY (7669)  
Appelez le numéro de téléphone qui apparaît sur votre carte/police de garantie. Ne retournez pas le produit au magasin.

### Centro de Asistencia de Sony

<https://esupport.sony.com/ES/LA/>  
Llame al número de teléfono que aparece en su tarjeta/poliza de garantía. Por favor no devuelva el producto a la tienda donde adquirió el producto.

© 2025 Sony Corporation

Dimensions and weight (without Table-Top Stand) / Dimensiones y poids (sans support de table) / Dimensiones y peso (sin soporte de sobremesa)

	(mm)/(inches/pouces/pulgadas)*1		(kg)/(lb.)**1	
	Ⓐ	Ⓑ	Ⓒ	Ⓓ
K-65XR80M2 / 65XR80CM2	1443 / 56 7/8	830 / 32 3/4	34 / 1 3/8	22.9 / 50.5
K-55XR80M2 / 55XR80CM2	1224 / 48 1/4	707 / 27 7/8	34 / 1 3/8	17.2 / 37.9

\*1 (Approx. / Environ / Aprox.)

Dimensions and weight (with Table-Top Stand) / Dimensiones y poids (avec support de table) / Dimensiones y peso (con soporte de sobremesa)

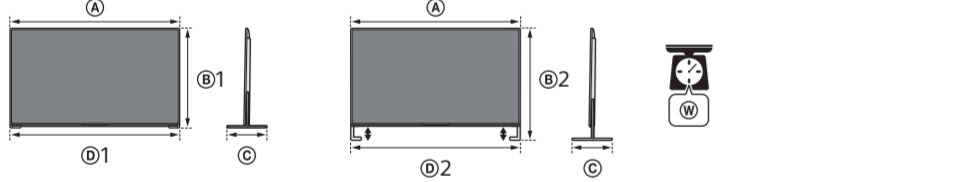

	(mm)/(inches/pouces/pulgadas)*1		(kg)/(lb.)**1	
	Ⓐ	Ⓑ	Ⓒ	Ⓓ
K-65XR80M2 / 65XR80CM2	1443 / 56 7/8	844 / 33 1/4	905 / 35 3/4	339 / 13 3/8
K-55XR80M2 / 55XR80CM2	1224 / 48 1/4	722 / 28 1/2	783 / 30 7/8	275 / 10 7/8

\*1 (Approx. / Environ / Aprox.)

The length of the screw for Wall-Mount Bracket differs depending on the Wall-Mount Bracket thickness / La longitud del tornillo para el soporte de montaje mural varía dependiendo del espesor del soporte de montaje mural

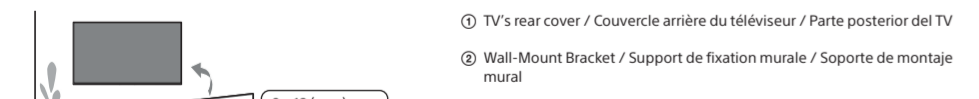

Information for the remote control with voice command included with this product: Model: RMF-TX820U\*1 Brand: Sony

Optional Camera and Microphone Unit (not supplied) Cable Management / Gestion du câble de la caméra avec microphone en option (non fourni) / Manejo del cable de la unidad de cámara y micrófono opcional (no suministrado)

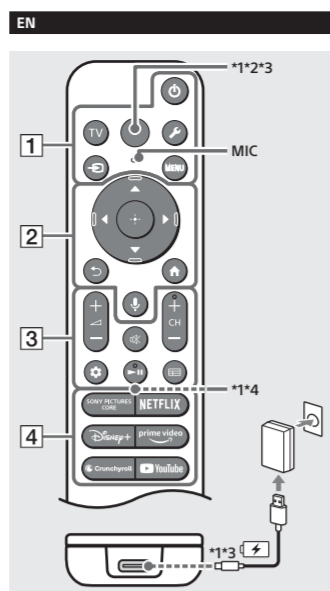
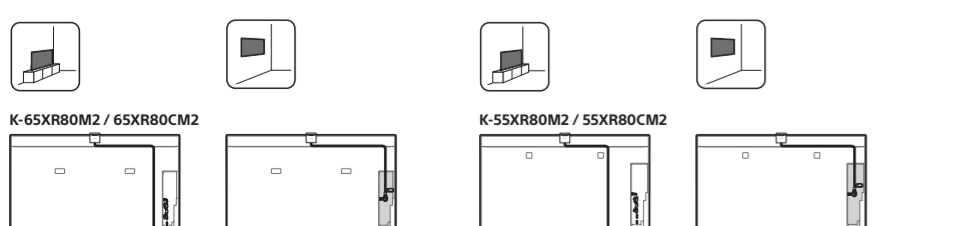

The remote control shape, layout, availability and function of remote control buttons may vary depending on your region/country/TV model/TV settings.

- (Power)** TV: Display TV channel list or switch to input. **(Quick Settings)**: Display Quick Settings. **(Input)**: Display and select the input source, etc. **MENU (Control menu)**: Display the Control menu. **(Back)** **(Home)** **(Google Assistant / Microphone)**: Use Google Assistant\*\*4. **(Volume)** **(Mute)\*\*** **CH +/- (Channel)** **(Dashboard)**: Display Dashboard. **(Guide)**: Display the digital program guide of TV or Cable/satellite box\*\*.

**2** For instructions on using the Wall-Mount Bracket with your TV please go to <https://www.sony.com/am/support> for your TV model and download "Wall-Mount Bracket".

**3** Anchor the TV to the wall by using bolts, wall anchor and chain (or rope).

**4** **RFM-TX920U only.** To see the model name of the remote control, open the remote control cover and see the label on the remote control. **5** The remote control backlight will illuminate when the light sensor detects the ambient light is low. Automatic illumination of the backlight can be turned off. **6** Google Assistant requires an Internet connection. **7** Accessibility shortcut is available by pressing and holding **(Mute)**. **8** (Cable/Satellite box setup) setting is required.

**Location of the identification label**  
Labels for the TV Model No. and Power Supply rating are located on the rear of the TV. They can be found by removing the terminal cover.

Model Name	Serial No.
K-65XR80M2 / 65XR80CM2	1443 / 56 7/8
K-55XR80M2 / 55XR80CM2	1224 / 48 1/4

**IMPORTANT NOTICE FOR MEXICO**  
Operation of this equipment is subject to the following two conditions: (1) it is possible that the remote control or device may not cause harmful interference and (2) this equipment or device must accept any interference, including interference that may cause undesired operation.

For information related to the certificate number, refer to the package label and / or product.

Note: This product utilizes the following device for wireless functionalities: Model: J20H03 Brand: FOXCONN

WLAN: 2.4 GHz (2,4000 GHz - 2,4835 GHz) 5 GHz (5,150 GHz - 5,850 GHz) 6 GHz (5,925 GHz - 6,425 GHz) Bluetooth: 2.4 GHz (2,4000 GHz - 2,4835 GHz)

Note: Uses the following device for wireless functionalities: Model: UE878 Brand: UEI

\*1 To see the model name of the remote control, open the remote control cover and see the label on the remote control.

**Safety Information**

**Notice for customers in the U.S.A.**

**Supplier's Declaration of Conformity**  
Trade Name: SONY  
Model: K-65XR80M2 / K-65XR80CM2 / K-55XR80M2 / K-55XR80CM2  
Responsible Party: Sony Electronics Inc.  
Address: 16535 Via Espinillo, San Diego, CA 92127 U.S.A.  
Telephone Number: 858-942-2230

### Compatible Wall-Mount Bracket Information

Sony TV Model No.	Compatible Wall-Mount Bracket Model No.
K-65XR80M2 / 65XR80CM2 / K-55XR80M2 / K-55XR80CM2	SU-WL855**

Use with other Wall-Mount Brackets\*\* may cause instability and could result in property damage or injury.

\*1 Only for limited region/country/model.  
\*2 For instructions on using the Wall-Mount Bracket with your TV please go to <https://www.sony.com/am/support> for your TV model and download "Wall-Mount Bracket".

**To Customers**  
Sufficient expertise is required for TV installations. Be sure to subcontract the installation to a Sony dealer or licensed contractor and pay adequate attention to safety during the installation.

**Before setting up your TV**  
Some TV models are packaged with a detached Table-Top Stand so you can mount your TV to a wall right away. See "Installing the TV to the Wall" if you want to mount the TV to a wall. If you are not mounting the TV to a wall, you will need to attach the Table-Top Stand (refer to the Setup Guide).

- Be sure to consider the following while setting up your TV.
  - Two or more persons are needed to transport a large TV set.
  - Correct hand placement while carrying the TV is very important for safety and to avoid damage.
  - When handling or mounting the TV set, do not lay down the TV (for applicable TV model only).

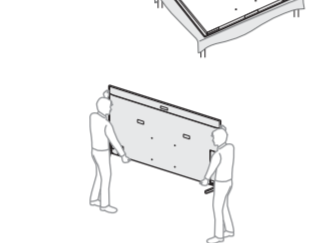

**Securing the TV**  
Sony strongly recommends taking measures to prevent the TV from toppling over. Unsecured TVs may topple and result in property damage, serious bodily injury or even death.

**Preventing the TV from Toppling**

- Secure the TV to a wall and/or Stand.
- Do not allow children to play or climb on furniture and TV sets.
- Avoid placing or hanging items on the TV.
- Never install the TV on:
  - slippery, unstable and/or uneven surfaces.
  - furniture that can easily be used as steps, such as a chest of drawers.
- Fasten the TV where it cannot be pulled, pushed, or knocked over.
- Install the TV so that the TV's Table-Top Stand does not protrude out from the Stand (not supplied). If the Table-Top Stand protrudes out from the Stand, it may cause TV set to topple over, fall down, and cause personal injury or damage to the TV.

Fluorescent lamps can interfere with your remote control; try turning off the fluorescent lamps.

**Installing the TV to the Wall**  
Using the optional Wall-Mount Bracket (SU-WL855 only)\*1 (not supplied)

**To Customers:**  
For product protection and safety reasons, Sony strongly recommends that installation of your TV be performed by Sony dealers or licensed contractors. Do not attempt to install it yourself.

**To Sony Dealers and Contractors:**  
Provide full attention to safety during the installation, periodic maintenance and examination of this product.

**Wall-Mount Bracket Installation Information**  
For instructions on Wall-Mount Bracket installation, see the Installation Information (Wall-Mount Bracket) on the Sony Customer Support website for your TV model at the following address: <https://www.sony.com/am/support>

- Secure the Stand (not the TV). Make sure the Stand can adequately support the weight of the TV. Use two angle braces (not supplied) to secure the Stand. For each angle brace use the appropriate hardware to:
  - Attach one side of the angle brace to the wall stud.
  - Attach the other side to the Stand.

- Secure the TV to the Stand. Use the optional hardware listed as follows (not supplied):
  - M6 machine screws (screwed into the TV's rear cover).
  - A screw or similar (attach it to the Stand).
  - Rope or chain (strong enough to support the weight of the TV). Make sure that there is no excess slack in the rope or chain.

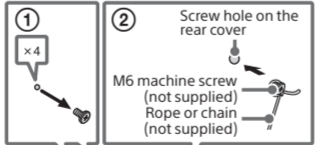

Note: Read the supplied safety documentation for additional safety information.

\*1 Only for limited region/country/model.

**Using the optional Wall-Mount Bracket (except SU-WL855) (not supplied)**  
This TV's instruction manual only provides the steps to prepare the TV for Wall-Mount installation before it's installed on the wall.

Your TV can be mounted to a wall using a suitable Wall-Mount Bracket (not supplied). If the Table-Top Stand is attached to the TV, the TV may require detaching the Table-Top Stand; see "Detaching the Table-Top Stand" for the TV model for the Wall-Mount Bracket before making cable connections.

**For product protection and safety reasons, Sony strongly recommends that installation of your TV on the wall be performed by qualified professionals. Do not attempt to install it yourself.**

- Follow the instruction guide provided with the Wall-Mount Bracket for your model. Sufficient expertise is required in installing this TV, especially to determine the strength of the wall for withstanding the TV's weight.
- The screws for installing the Wall-Mount Bracket to the TV are not supplied.

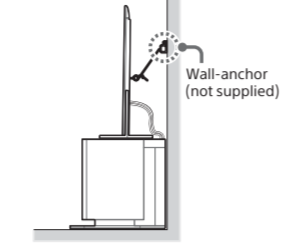
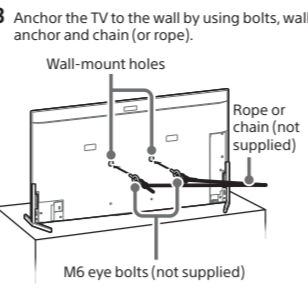

Please refer to below illustration for M6 eye bolt length.



Note: Your TV is shipped with screws attached to the rear of the TV (depending on the TV model). They are fastened in the screw holes for wall mounting. Be sure to remove the upper two screws prior to anchoring the TV to a wall.

- Securing the TV to the Stand without securing the TV and the Stand to the wall provides minimum protection against the TV toppling over. For further protection, be sure to follow the three measures recommended.

**The BRAVIA® 4K TV Experience**  
Thank you for choosing Sony! Your new BRAVIA® TV opens the door to the "4K TV Experience." This document will help you get the most out of your TV.

This TV displays all video input signals in a resolution of 3 840 dots × 2 160 lines.

Note: For supported PC formats, refer to the online Help Guide.

**Guidelines for IR Remote Control**

- Point your remote control directly at the IR sensor located on your TV.
- Make sure that no objects are blocking the path between the remote control and the IR sensor on your TV.

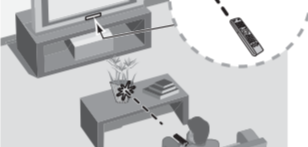

Note: If using an electric screwdriver, set the torque at approximately 1.5 N·m (15 kgf·cm).

**Detaching the Table-Top Stand from the TV**  
To detach the Table-Top Stand from the TV, remove the screws **(1)**.

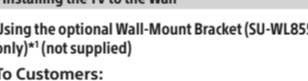

Note: Be careful when lifting the TV as the Table-Top Stand is attached to the TV. The TV may topple over and cause personal injury.

**Troubleshooting**  
General troubleshooting for issues like: black screen, no sound, frozen picture, TV does not respond, or network is lost, do the following steps:

- Restart your TV by pressing the power button on the remote control for about five seconds. The TV will restart. If the TV does not recover, try unplugging the AC power cord then press the power button on the TV and release it. Wait for two minutes, and plug in the AC power cord.

- Connect your TV to the Internet and perform a software update. Sony recommends you to keep your TV software updated. Software updates provide new features and performance improvements.

- Visit Sony support website (information provided on the front cover of this manual).

- Perform the factory data reset.

**When you plug in the TV, the TV may not be able to turn on for a while even if you press the power button on the remote control or the TV.**

It takes time to initialize the system. Wait for about one minute, then operate it again.

**How to reset the TV to factory settings**  
WARNING: The reset will clear all of your customized settings including the parental lock setting.

You can reset the TV to factory settings by selecting [Factory data reset]. How to select [Factory data reset], refer to the online Help Guide.

- To force factory data reset, unplug the AC power cord. Press and hold **(D)** button on the TV, then plug in the AC power cord.

For security purposes, be sure to remove all personal and account information before discarding, selling or passing your TV to someone else by: unlinking/unregistering, signing out of and deactivating all network services as well as factory reset the TV.

### Refer to the following table for the wall-mount hole pattern.

	(mm)	
	a	b
K-65XR80M2 / 65XR80CM2	300	300
K-55XR80M2 / 55XR80CM2	300	300

Be sure to store the unused screws and Table-Top Stand in a safe place until you are ready to attach the Table-Top Stand. Keep the screws away from children.

Note: Read the supplied safety documentation for additional safety information.

\*1 Only for limited region/country/model.

**1** Remove the stand covers and terminal covers.

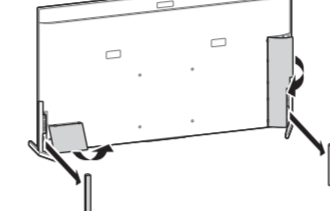

**2** Remove the screws from the rear of the TV.

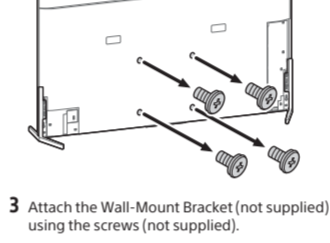

**3** Attach the Wall-Mount Bracket (not supplied) using the screws (not supplied).

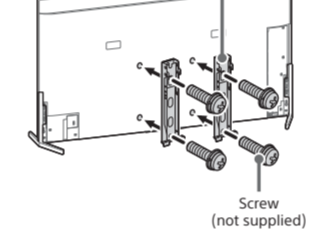

Note: If using an electric screwdriver, set the torque at approximately 1.5 N·m (15 kgf·cm).

**Detaching the Table-Top Stand from the TV**  
To detach the Table-Top Stand from the TV, remove the screws **(1)**.

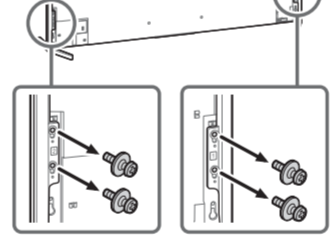

Note: Be careful when lifting the TV as the Table-Top Stand is attached to the TV. The TV may topple over and cause personal injury.

**Troubleshooting**  
General troubleshooting for issues like: black screen, no sound, frozen picture, TV does not respond, or network is lost, do the following steps:

- Restart your TV by pressing the power button on the remote control for about five seconds. The TV will restart. If the TV does not recover, try unplugging the AC power cord then press the power button on the TV and release it. Wait for two minutes, and plug in the AC power cord.

- Connect your TV to the Internet and perform a software update. Sony recommends you to keep your TV software updated. Software updates provide new features and performance improvements.

- Visit Sony support website (information provided on the front cover of this manual).

- Perform the factory data reset.

**When you plug in the TV, the TV may not be able to turn on for a while even if you press the power button on the remote control or the TV.**

It takes time to initialize the system. Wait for about one minute, then operate it again.

**How to reset the TV to factory settings**  
WARNING: The reset will clear all of your customized settings including the parental lock setting.

You can reset the TV to factory settings by selecting [Factory data reset]. How to select [Factory data reset], refer to the online Help Guide.

- To force factory data reset, unplug the AC power cord. Press and hold **(D)** button on the TV, then plug in the AC power cord.

For security purposes, be sure to remove all personal and account information before discarding, selling or passing your TV to someone else by: unlinking/unregistering, signing out of and deactivating all network services as well as factory reset the TV.

### The remote control does not function.

- Replace the batteries (except RMF-TX920U).
- Check if the insulating sheet is removed from the remote control (RMF-TX920U only).
- Change the remote control and confirm the remote control is connected via Bluetooth® (RMF-TX920U only).

**The parental lock password has been forgotten.**  
Enter 4357 for the PIN and enter the new PIN.

**The screen becomes darker while watching TV.**  
If the whole image or part of the image remains still, the screen brightness will be gradually reduced to prevent image retention. This is not a malfunction of the TV.

**You are concerned about image retention.**  
If the same image is displayed repeatedly or for long periods of time, image retention may occur. To reduce image retention, we recommend that you turn off the TV normally by pressing the power button on the remote control or the TV.

Note: Images that include logos and bright colors (including white) easily cause image retention. Avoid displaying these types of images for long periods of time, otherwise image retention may occur.

**The message [Panel refresh did not finish...] is displayed.**  
When i) the TV is turned on, ii) the AC power cord is unplugged, or iii) the room temperature falls below 10 °C (and 40 °C) during the Panel refresh, the Panel refresh is not completed. Please avoid the above three conditions during the Panel refresh.

For more information, refer to the Help Guide. Press **(Quick Settings)** on the remote control and select **[Help]**. **[Help]** does not exist, select **[Edit]** and add **[Help]**.

**Specifications**

**System**  
TV system: NTSC, National Television System Committee ATSC, 8VSB Terrestrial  
NEXTGEN TV: ATSC 3.0 compliant (Single tuner)\*\*

QAM on cable: ANSI/SCTE 07 2000 (Does not include CableCARD functionality)  
Channel coverage: Analog terrestrial: 2 - 69 / Digital terrestrial: 2 - 69\*\*

Analog Cable: 1 - 135 / Digital Cable: 1 - 135  
Panel system: OLED (Organic Light Emitting Diode) Panel  
Wireless technology: Protocol IEEE 802.11a/b/g/n/ac/ax Bluetooth: Version 5.3

**Input/Output jacks**  
CABLE INPUT: 75 ohm external terminal for RF input  
HDMI IN 1/2/3/4 (HDMI IN 3 eARC/ARC)  
HDMI IN 3 and 4 support 120 Hz DIGITAL AUDIO OUT (OPTICAL), S-CENTER SPEAKER IN

Two channel linear PCM: 48 kHz bit, Dolby Audio, DTS  
USB (USB 2.0, 500 mA), USB 2 (USB 3.2 Gen 1, 900 mA)  
LAN (LAN IN/SE-1/100BASE-TX)  
REMOTE (RS-232C, IR IN)

**Power and others**  
Power requirements: 110 V - 240 V AC, 50/60 Hz (U.S.A./Canada)  
120 V AC, 60 Hz  
Power consumption: In use (W): K-65XR80M2 / 65XR80CM2: 397 K-55XR80M2 / 55XR80CM2: 313 In standby (W): Less than 0.5 W with 120 V AC and less than 0.5 W with 240 V AC

Screen size (measured diagonally) (Approx. cm/inches): K-65XR80M2 / 65XR80CM2: 163.9 / 64.5 (65" class) K-55XR80M2 / 55XR80CM2: 138.8 / 54.6 (55" class)  
Display resolution (horizontal × vertical) (pixels): 3 840 × 2 160  
Output range: 500 mA (for USB 1), 900 mA (for USB 2)

**Others**  
Operating temperature: 0 °C - 40 °C / 32 °F - 104 °F  
Remote control charging temperature (RMF-TX920U only): 5 °C - 40 °C / 41 °F - 104 °F  
Optional accessories: Wall-Mount Bracket: SU-WL855 Camera and Microphone Unit: CMU-BC1

\*1 Available only when region/country is set to U.S.A.  
\*2 2 - 36 for NEXTGEN TV scanning range in U.S.A.  
\*3 Specified standby power is reached after the TV finishes necessary internal processes.  
\*4 Standby power consumption will increase when your TV is connected to the network.

Note: Optional accessories availability depends on countries/region/TV model/stock.  
Design and specifications are subject to change without notice.  
Subscriptions for services and applications may be required and additional terms, conditions and/or charges may apply when using Google Assistant.

Power consumption will increase when the built-in MIC is enabled as it is always listening.  
Visit Sony website for more information on product specifications.

**Licensing Information**  
Dolby, Dolby Vision, Dolby Atmos, Dolby Audio, and the double-D symbol are trademarks of Dolby Laboratories Licensing Corporation. Manufactured under license from Dolby Laboratories. Content trademarks unpublished works. Copyright © 1992-2024 Dolby Laboratories. All rights reserved.

Gracenote, the Gracenote logo and logotype, "Powered by Gracenote" logo are either registered trademarks or trademarks of Gracenote, Inc. in the U.S.A. and/or other countries.

Power consumption will increase when the built-in MIC is enabled as it is always listening.  
Visit Sony website for more information on product specifications.

**AVIS IMPORTANT POUR LE MEXIQUE**  
L'exploitation de cet appareil est autorisée aux deux conditions suivantes: (1) il faut que cet équipement ou appareil ne provoque pas d'interférences nuisibles, et (2) cet équipement ou appareil doit accepter toute interférence, y compris les interférences pouvant entraîner un fonctionnement indésirable.

Para más información sobre el producto, consulte el sitio web de soporte técnico de Sony.

Para más información sobre el producto, consulte el sitio web de soporte técnico de Sony.

Para más información sobre el producto

