

FMIU020X



Product family	Microwave oven
Category	Built-in
Installation type	Built-in
Installation	With frame
Power source	Electrical
Cooking Method	Microwave with grill
Oven controls	Electro-mechanical



Aesthetic

Color	Stainless steel	Silkscreen color	Black
Finishing	Fingerprint-proof	Door	With frame
Frame	Yes	Handle color	Stainless steel effect
Material	Stainless steel	Logo	Embossed
Stainless steel type	Brushed		

Program / Functions

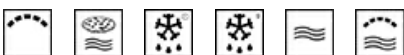

Number of functions	6	Defrost by weight	Yes
Large grill	Yes	Microwave	Yes
Pizza	Yes	Microwave + grill	Yes
Defrost by time	Yes	Automatic programs	8

Controls

Display	1 LED	No. of controls	1
Controls	Controls knobs / Buttons	Control knobs	Push-push
Opening	Button	Controls color	Stainless steel effect

Options



Timer	Electronic	Child safety lock	Yes
Time-setting options	End-of-cooking	Quick-start option	Yes

End-of-cooking acoustic alarm Yes

Technical Features



Cavity material	Stainless steel	Grill - power	1000 W
No. of lights	1	Total no. of door glasses	1
Lighting	LED	Security Thermostat	Yes
Turntable	Yes	Cooling system	Tangential
Turntable dimensions	9 5/8 "	Microwave door protection screen	Yes
Light on when door is open	Yes	Microwave stops when door is opened	Yes
Grill type	Heating element	Microwave effective power	800 W

Accessories Included

Grid	1	Frame	Yes
-------------	---	--------------	-----

Performance / Energy Label









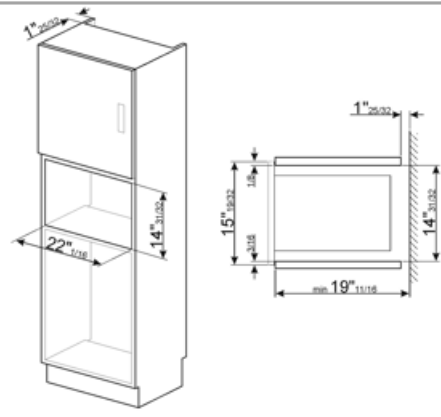
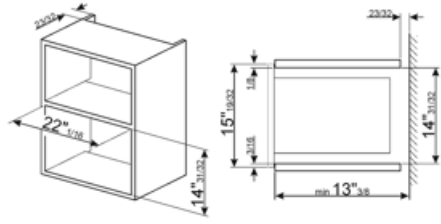
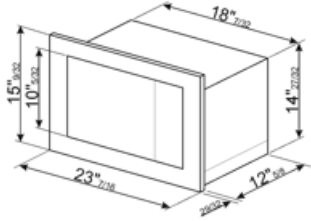



Volume	21 cu. ft.
---------------	------------

Electrical Connection

Plug	(B) NEMA 5-15P	Voltage	120 V
Nominal power	1350 W	Frequency	60 Hz
Current	11 A	Power cord length	59 1/16 "



Symbols glossary

- | | | | |
|--|--|---|---|
|  | Child lock: some models are fitted with a device to lock the programme/cycle so it cannot be accidentally changed. |  | Microwave energy shortens cooking times dramatically and produces energy savings. |
|  | Defrost by time: with this function the time of thawing of foods are determined automatically. |  | Defrost by weight: With this function the defrosting time is determined |
|  | Fingerprint proof stainless steel: Fingerprint proof stainless steel keeps stainless steel looking as good as new. |  | Grill element: Using of grill gives excellent results when cooking meat of medium and small portions, especially when combined with a rotisserie (where possible). Also ideal for cooking sausages and bacon. |
|  | Microwave: Penetrating straight into the food, microwaves cook very quickly and with considerable energy savings. Suitable for cooking without fat, they are also able to thaw and heat food without altering its original appearance and aroma. The microwave function can also be combined with conventional functions with all the resulting advantages. Ideal for all types of food. |  | Microwave + grill element: The use of the grill results in a perfect browning of the surface of the food. The action of microwaves allows instead of cooking in a short time the internal part of the food. |
|  | Pizza microwave: This function cooks pizza quicker thanks to the microwaves. To optimize the final result, use the function combined with the Chef plate |  | Side lights: Two opposing side lights increase visibility inside the oven. |
|  | The capacity indicates the amount of usable space in the oven cavity in litres. | | |