

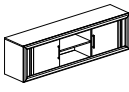



# ASSEMBLY INSTRUCTIONS

ITEM : B9230-9 TV STAND  
B9235-9 TV STAND

**BOX OF TV STAND PART LIST**

ITEM	DRAWING	DESCRIPTION	QTY
A		TV STAND	1
B		LEG	4
C		CENTER SUPPORT LEG	1

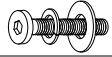
**BOX OF TV STAND HARDWARE LIST**

ITEM	DRAWING	DESCRIPTION	QTY
1		JCBC SCREW M6 x 40MM	4 PCS
2		WOOD DOWEL Ø8 x 30MM	4 PCS
3		ALLEN KEY M4 x 65MM	1 PC

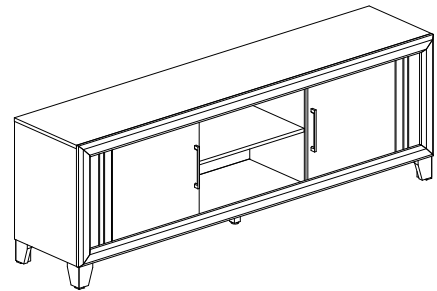

**COMPLETED ASSEMBLY**

**STEP 1**

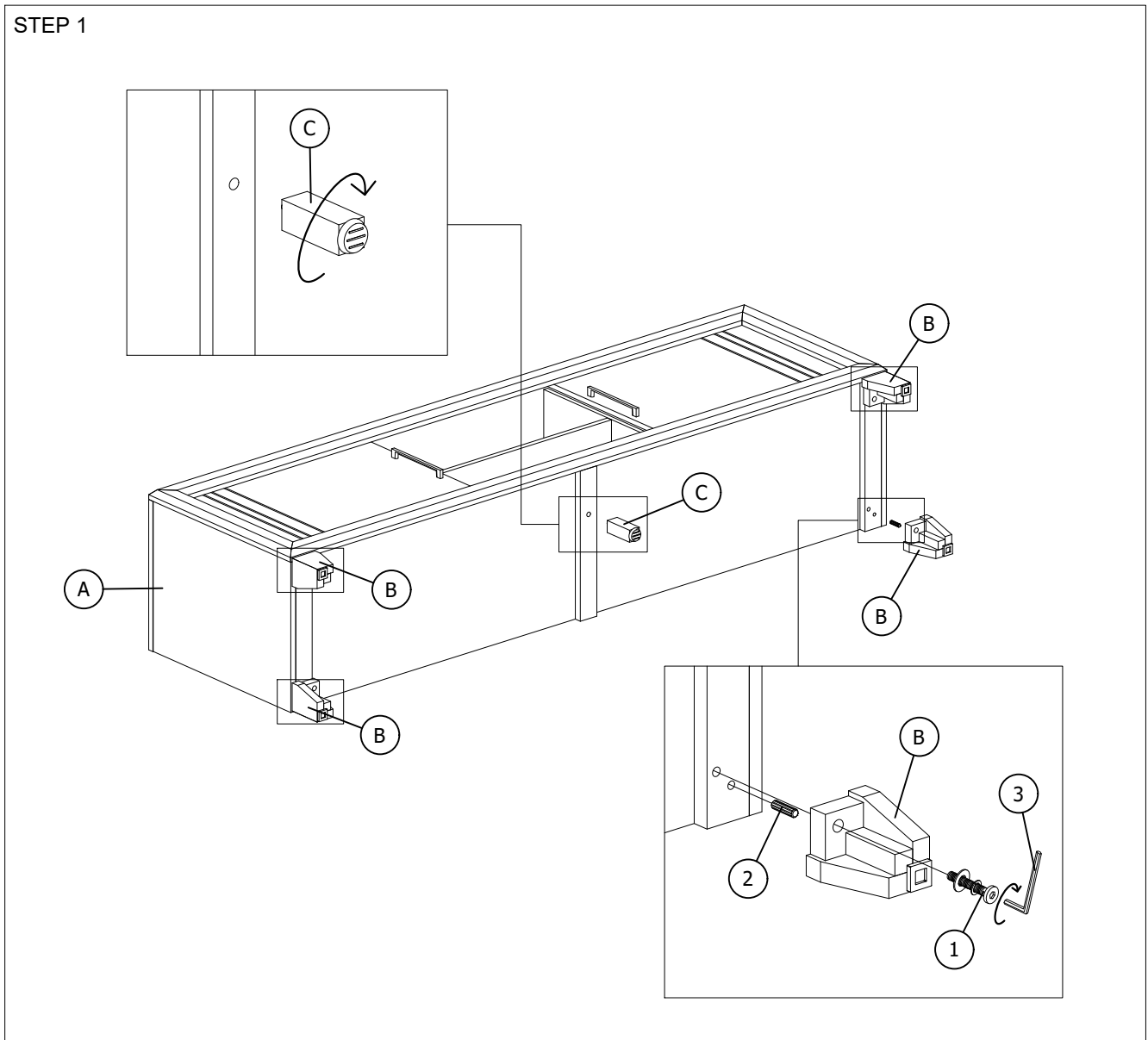

THE HARDWARE IS LOCATED IN THE PACKING ITEMS

NOTE : Periodically check to ensure that all connectors (bolts, screws, etc.) are tight.