



Use & Care Manual



Professional Freestanding Ranges



Viking Range, LLC
111 Front Street
Greenwood, Mississippi 38930 USA
(662) 455-1200

For product information,
call 1-888-845-4641
or visit the Viking Web site at vikingrange.com

Congratulations

Congratulations and welcome to the elite world of Viking ownership. We hope you will enjoy and appreciate the care and attention we have put into every detail of your new, state-of-the-art range.

Your Viking range is designed to offer years of reliable service. This Use and Care Manual will provide you with the information you need to become familiar with your range's care and operation.

Your complete satisfaction is our ultimate goal. If you have any questions or comments about this product, please contact the dealer from whom you purchased it, or contact our Consumer Support Center at 1-888-845-4641.

We appreciate your choice of a Viking range and hope that you will again select our products for your other major appliance needs.

For more information about the complete and growing selection of Viking products, contact your dealer or visit us online at vikingrange.com.

Table of Contents

Getting Started

Warnings	4
Before Using Range	15

Product Controls

Gas Range Features	18
Dual fuel Range Features	20
Oven Functions and Settings	22

Operation

Surface Operation	24
Lighting Burners	24
Surface Burners-Automatic Reignition	24
Vari-Simmer™	25
Surface Cooking Tips	25
Cooking Vessels	26
Griddle/Simmer Plate	27
Oven Features	29
Rack Positions	29
Using the Oven	30
Conventional and Convection Cooking	30
Baking	30
Bake (VGR Gas Ranges)	30
Convection Bake (VGR Gas Ranges)	30
Bake (VDR Dual Fuel Ranges)	32
Convection Bake (VDR Dual Fuel Ranges)	33
Roasting (VDR Dual Fuel Ranges)	38
Kitchen Thermometer Accessory	42
Broiling (VGR Gas Ranges)	44
Broiling (VDR Gas Ranges)	45
Convection Dehydrate	49
Convection Defrost	49

Product Care

Cleaning and Maintenance	50
Self-Clean Cycle (Dual Fuel models)	52
Replacing Oven Lights	55
Door Removal	56
Door Replacement	57
Troubleshooting	58
Service Information	59
Warranty	60

Warnings

Warning and Important Safety Instructions appearing in this manual are not meant to cover all possible conditions and situations that may occur. Common sense, caution, and care must be exercised when installing, maintaining, or operating the appliance.

ALWAYS contact the manufacturer about problems or conditions you do not understand.

Recognize Safety Symbols, Words, Labels

DANGER

Hazards or unsafe practices which **WILL** result in severe personal injury or death

WARNING

Hazards or unsafe practices which **COULD** result in death or severe personal injury

CAUTION

Hazards or unsafe practices which **COULD** result in minor personal injury.

All safety messages will identify the hazard, tell you how to reduce the chance of injury, and tell you what can happen if the instructions are not followed.

Read and follow all instructions before using this appliance to prevent the potential risk of fire, electric shock, personal injury or damage to the appliance as a result of improper usage of the appliance. Use appliance only for its intended purpose as described in this manual.

To ensure proper and safe operation: Appliance must be properly installed and grounded by a qualified technician. **DO NOT** attempt to adjust, repair, service, or replace any part of your appliance unless it is specifically recommended in this manual. All other servicing should be referred to a qualified servicer. Have the installer show you the location of the gas shutoff valve and how to shut it off in an emergency. A certified technician is required for any adjustments or conversions to Natural or LP gas.

KEEP THESE INSTRUCTIONS FOR FUTURE REFERENCE.

Warnings

WARNING

If the information in this manual is not followed exactly, a fire or explosion may result causing property damage, personal injury or death.

WHAT TO DO IF YOU SMELL GAS:

- **DO NOT** try to light any appliance.
- **DO NOT** touch any electrical switch.
- **DO NOT** use any phone in your building.
- Immediately call your gas supplier from a neighbor's phone. Follow the gas supplier's instructions.
- If you cannot reach your gas supplier, call the fire department.

Installation and service must be performed by a qualified installer, service agency or the gas supplier.

WARNING



TIPPING HAZARD

To reduce the risk of the appliance tipping, it must be secured by a properly installed anti-tip bracket(s). To make sure the bracket has been installed properly, look behind the range with a flashlight to verify proper installation engaged in the rear bottom left corner of the range.

- **THIS RANGE CAN TIP**
- **INJURIES TO PERSONS CAN RESULT**
- **INSTALL ANTI-TIP DEVICE PACKED WITH RANGE**
- **SEE INSTALLATION INSTRUCTIONS**

WARNING

DO NOT use commercial oven cleaners inside the oven. Use of these cleaners can produce hazardous fumes or can damage the porcelain finishes.

WARNING



To avoid risk of property damage, personal injury or death; follow information in this manual exactly to prevent a fire or explosion. **DO NOT** store or use gasoline or other flammable vapors and liquids in the vicinity of this or any appliance.

Warnings

To Prevent Fire or Smoke Damage

- Be sure all packing materials are removed from the appliance before operating it.
- Keep area around appliance clear and free from combustible materials, gasoline, and other flammable vapors and materials.
- If appliance is installed near a window, proper precautions should be taken to prevent curtains from blowing over burners.
- **NEVER** leave any items on the rangetop. The hot air from the vent may ignite flammable items and may increase pressure in closed containers which may cause them to burst.
- Many aerosol-type spray cans are **EXPLOSIVE** when exposed to heat and may be highly flammable. Avoid their use or storage near an appliance.
- Many plastics are vulnerable to heat. Keep plastics away from parts of the appliance that may become warm or hot. **DO NOT** leave plastic items on the range as they may melt or soften if left too close to the vent or a lighted surface burner.
- Combustible items (paper, plastic, etc.) may ignite and metallic items may become hot and cause burns. **DO NOT** pour spirits over hot foods. **DO NOT** leave oven unsupervised when drying herbs, breads, mushrooms, etc; fire hazard.

In Case of Fire

Turn off appliance and ventilating hood to avoid spreading the flame. Extinguish flame then turn on hood to remove smoke and odor.

- **Cooktop:** Smother fire or flame in a pan with a lid or cookie sheet.
- **NEVER** pick up or move a flaming pan.
- **Oven:** Smother fire or flame by closing the oven door. **DO NOT** use water on grease fires. Use baking soda, a dry chemical or foam-type extinguisher to smother fire or flame.
- **GREASE**—Grease is flammable and should be handled carefully. **DO NOT** use water on grease fires. Flaming grease can be extinguished with baking soda or, if available, a multipurpose dry chemical or foam type extinguisher. Let fat cool before attempting to handle it. **DO NOT** allow grease to collect around the oven or in vents. Wipe up spillovers immediately.

Child Safety

- **NEVER** leave children alone or unsupervised near the appliance when it is in use or is still hot.
- **NEVER** allow children to sit or stand on any part of the appliance as they could be injured or burned.
- **DO NOT** store items of interest to children over the unit. Children climbing to reach items could be seriously injured.

Warnings

Child Safety (cont.)

- Children must be taught that the appliance and utensils in it can be hot. Let hot utensils cool in a safe place, out of reach of small children. Children should be taught that an appliance is not a toy. Children should not be allowed to play with controls or other parts of the appliance.

Cooking Safety

- To eliminate the hazard of reaching over hot surface burners, cabinet storage should not be provided directly above a unit. If storage is provided, it should be limited to items which are used infrequently and which are safe to store in an area subjected to heat from an appliance. Temperatures may be unsafe for some items, such as volatile liquids, cleaners or aerosol sprays.
- **ALWAYS** place a pan on a surface burner before turning it on. Be sure you know which knob controls which surface burner. Make sure the correct burner is turned on and that the burner has ignited. When cooking is completed, turn burner off before removing pan to prevent exposure to burner flame.
- **ALWAYS** adjust surface burner flame so that it does not extend beyond the bottom edge of the pan. An excessive flame is hazardous, wastes energy and may damage the appliance, pan or cabinets above the appliance. This is based on safety considerations.
- **NEVER** leave a surface cooking operation unattended especially when using a high heat setting or when deep fat frying. Boilovers cause smoking and greasy spillovers may ignite. Clean up greasy spills as soon as possible.
- **DO NOT** use high heat for extended cooking operations.
- **DO NOT** heat unopened food containers, build up of pressure may cause the container to explode and result in injury.
- Use dry, sturdy pot-holders. Damp pot-holders may cause burns from steam. Dishtowels or other substitutes should **NEVER** be used as potholders because they can trail across hot surface burners and ignite or get caught on appliance parts.
- **ALWAYS** let quantities of hot fat used for deep fat frying cool before attempting to move or handle.
- **DO NOT** let cooking grease or other flammable materials accumulate in or near the appliance, hood or vent fan. Clean hood frequently to prevent grease from accumulating on hood or filter. When flaming foods under the hood, turn the fan off.
- **NEVER** wear garments made of flammable material or loose fitting or long-sleeved apparel while cooking. Clothing may ignite or catch utensil handles. **DO NOT** drape towels or materials on oven door handles. These items could ignite and cause burns.

Warnings

Cooking Safety (cont.)

- **ALWAYS** place oven racks in the desired positions while oven is cool. Slide oven rack out to add or remove food, using dry, sturdy pot-holders.
- **ALWAYS** avoid reaching into the oven to add or remove food. If a rack must be moved while hot, use a dry pot-holder.
- **ALWAYS** turn the oven off at the end of cooking.
- Use care when opening the oven door. Let hot air or steam escape before moving or replacing food.
- **NEVER** use aluminum foil to cover oven racks or oven bottom. This could result in risk of electric shock, fire, or damage to the appliance. Use foil only as directed in this guide.
- **NEVER** cook with the oven door open. This could result in control panel and knobs reaching a higher than normal temperature.
- **PREPARED FOOD WARNING:** Follow food manufacturer's instructions. If a plastic frozen food container and/or its cover distorts, warps, or is otherwise damaged during cooking, immediately discard the food and its container. The food could be contaminated.
- If you are "flaming" liquor or other spirits under an exhaust, **TURN THE FAN OFF**. The draft could cause the flames to spread out of control.
- Once the unit has been installed as outlined in the Installation Instructions, it is important that the fresh air supply is not obstructed. The use of a gas cooking appliance results in the production of heat and moisture in the room in which it is installed. Ensure that the kitchen is well-ventilated. Keep natural venting holes open or install a mechanical ventilation device. Prolonged or intensive use of the appliance may call for additional (such as opening a window) or more effective ventilation (such as increasing the level of a mechanical ventilation if present).

Utensil Safety

- Use pans with flat bottoms and handles that are easily grasped and stay cool. Avoid using unstable, warped, easily tipped or loose-handled pans. Also avoid using pans, especially small pans, with heavy handles as they could be unstable and easily tip. Pans that are heavy to move when filled with food may also be hazardous.
- Be sure utensil is large enough to properly contain food and avoid boilovers. Pan size is particularly important in deep fat frying. Be sure pan will accommodate the volume of food that is to be added as well as the bubble action of fat.
- To minimize burns, ignition of flammable materials and spillage due to unintentional contact with the utensil, **DO NOT** extend handles over adjacent surface burners. **ALWAYS** turn pan handles toward the side or back of the appliance, not out into the room where they are easily hit or reached by small children.
- **NEVER** let a pan boil dry as this could damage the utensil and the appliance.
- Follow the manufacturer's directions when using oven cooking bags.

Warnings

Utensil Safety (cont.)

- Only certain types of glass, glass/ceramic, ceramic or glazed utensils are suitable for rangetop surface or oven usage without breaking due to the sudden change in temperature. Follow manufacturer's instructions when using glass.
- This appliance has been tested for safe performance using conventional cookware. **DO NOT** use any devices or accessories that are not specifically recommended in this guide. **DO NOT** use eyelid covers for the surface units, stovetop grills, or add-on oven convection systems. The use of devices or accessories that are not expressly recommended in this manual can create serious safety hazards, result in performance problems, and reduce the life of the components of the appliance.
- The flame of the burner should be adjusted to just cover the bottom of the pan or pot. Excessive burner setting may cause scorching of adjacent counter-top surfaces, as well as the outside of the utensil. This is based on safety considerations.

Heating Elements

- **NEVER** touch oven bake and broil burner areas or interior surfaces of oven.
- Bake and broil burners may be hot even though they are dark in color. Areas near burners and interior surfaces of an oven may become hot enough to cause burns.
- During and after use, **DO NOT** touch or let clothing or other flammable materials contact heating elements, areas near elements, or interior surfaces of oven until they have had sufficient time to cool. Other surfaces of the oven may become hot enough to cause burns, such as the oven vent opening, the surface near the vent opening, and the oven door window.

Cleaning Safety

- Turn off all controls and wait for appliance parts to cool before touching or cleaning them. **DO NOT** touch the burner grates or surrounding areas until they have had sufficient time to cool.
- Clean appliance with caution. Use care to avoid steam burns if a wet sponge or cloth is used to wipe spills on a hot surface. Some cleaners can produce noxious fumes if applied to a hot surface.
- **DO NOT** clean door gasket. It is essential for a good tight seal. Care should be taken not to rub, damage, or move the gasket.
- No commercial oven cleaner or oven liner protective coating such as aluminum foil should be used in or around any part of the oven. Improper oven liners may result in a risk of electric shock or fire. Keep oven free from grease buildup.

Warnings

Self-Clean Oven (VDR Dual Fuel Models)

- Clean only parts listed in this guide. **DO NOT** clean door gasket. The door gasket is essential for a good seal. Care should be taken not to rub, damage, or move the gasket. **DO NOT** use oven cleaners of any kind in or around any part of the self-clean oven.
- Before self-cleaning the oven, remove broiler pan, oven racks and other utensils and wipe up excessive spillovers to prevent excessive smoke, flare-ups or flaming.
- This range features a cooling fan which operates automatically during a clean cycle. If the fan does not turn on, cancel the clean operation and contact an authorized servicer.
- It is normal for the rangetop cooking surface of the range to become hot during a self-clean cycle. Therefore, touching the rangetop cooking surface during a clean cycle should be avoided.

Important Safety Notice and Warning (State of California Proposition 65)

WARNING: This product contains one or more chemicals known to the State of California to cause cancer.

WARNING: This product contains one or more chemicals known to the State of California to cause birth defects or other reproductive harm.

Users of this appliance are hereby warned that when the oven is engaged in the self-clean cycle, there may be some low-level exposure to some of the listed substances, including carbon monoxide. Exposure to these substances can be minimized by properly venting the oven to the outdoors by opening the windows and/or door in the room where the appliance is located during the self-clean cycle.

Important notice regarding pet birds:

NEVER keep pet birds in the kitchen or in rooms where the fumes from the kitchen could reach. Birds have a very sensitive respiratory system. Fumes released during an oven self-cleaning cycle may be harmful or fatal to birds. Fumes released due to overheated cooking oil, fat, margarine and overheated non-stick cookware may be equally harmful.

⚠ WARNING

NEVER use appliance as a space heater to heat or warm a room to prevent potential hazard to the user and damage to the appliance. Also, **DO NOT** use the rangetop or oven as a storage area for food or cooking utensils.

Warnings

About Your Appliance

- For proper oven performance and operation, **DO NOT** block or obstruct the oven vent ducts located inside the air grille.
- Avoid touching oven vent area while oven is on and for several minutes after oven is turned off. When the oven is in use, the vent and surrounding area become hot enough to cause burns. After oven is turned off, **DO NOT** touch the oven vent or surrounding areas until they have had sufficient time to cool.
- Other potentially hot surfaces include rangetop, areas facing the rangetop, oven vent, surfaces near the vent opening, oven door, areas around the oven door and oven window.
- The misuse of oven doors (e.g. stepping, sitting, or leaning on them) can result in potential hazards and/or injuries.

⚠ WARNING

POWER FAILURE WARNING

Due to safety considerations and the possibility of personal injury in attempting to light and extinguish the burners, the burners should not be used during a power failure under any circumstances.. The burner controls should always remain in the "OFF" position during a power failure.

Power Failure

If power failure occurs, the electric igniters will not work. No attempt should be made to operate the appliance during a power failure. Make sure the oven control is in the "OFF" position.

Momentary power failure can occur unnoticed. The range is affected only when the power is interrupted. When it comes back on, the range will function properly without any adjustments. A "brown-out" may or may not affect range operation, depending on how severe the power loss is. If the range is in the self-clean cycle when the power failure occurs, wait until power is restored and allow door to unlock automatically. Turn all controls off and restart self-clean cycle again, according to instructions.

⚠ WARNING



ELECTRICAL SHOCK HAZARD

DO NOT touch a hot oven light bulb with a damp cloth as the bulb could break. Should the bulb break, disconnect power to the appliance before removing bulb to avoid electrical shock.

Warnings

⚠ WARNING

NEVER cover any slots, holes or passages in the oven bottom or cover an entire rack with materials such as aluminum foil. Doing so blocks air flow through the oven and may cause carbon monoxide poisoning. Aluminum foil linings may also trap heat, causing a fire hazard.

⚠ WARNING**ELECTRICAL SHOCK HAZARD**

Disconnect the electric power at the main fuse or circuit breaker before replacing bulb.

⚠ WARNING**BURN OR ELECTRICAL SHOCK HAZARD**

Make sure all controls are OFF and oven is COOL before cleaning. Failure to do so can result in burns or electrical shock.

⚠ CAUTION

To avoid sickness and food waste, **DO NOT** allow defrosted food to remain in the oven for more than two hours.

⚠ CAUTION

This appliance is not intended for use by persons (including children) with reduced physical, sensory or mental capabilities, or lack of experience and knowledge, unless they have been given supervision or instruction concerning use of the appliance. Children should be supervised to ensure that they do not play with the appliance.

DO NOT store items of interest to children over the unit. Children climbing to reach items could be seriously injured.

Warnings

⚠ NOTICE

DO NOT turn the Temperature Control on during defrosting. Turning the convection fan on will accelerate the natural defrosting of the food without any heat.

⚠ CAUTION**BURN HAZARD**

The oven door, especially the glass, can get hot. **Danger of burning: DO NOT touch the glass!**

⚠ WARNING**Self-Clean Ranges**

During the self-clean cycle, the oven reaches elevated temperatures in order to burn off soil and deposits. A powder ash residue is left in the bottom of the oven after completion of the self-clean cycle.

Note: DO NOT use commercial oven cleaners inside the oven. Use of these cleaners can produce hazardous fumes or can damage the porcelain finishes. DO NOT line the oven with aluminum foil or other materials. These items can melt or burn during a self-clean cycle, causing permanent damage to the oven.

Warnings

⚠ CAUTION



DO NOT touch the exterior portions of the oven after self-cleaning cycle has begun, since some parts become extremely hot to the touch!

During the first few times the self-cleaning feature is used, there may be some odor and smoking from the “curing” of the binder in the high-density insulation used in the oven. When the insulation is thoroughly cured, this odor will disappear. During subsequent self-cleaning cycles, you may sense an odor characteristic of high temperatures.

KEEP THE KITCHEN WELL-VENTED DURING THE SELF-CLEAN CYCLE.

⚠ CAUTION

You must carefully check the food during the dehydration process to ensure that it does not catch fire.

⚠ WARNING



BURN HAZARD

When self-cleaning, surfaces may get hotter than usual. Therefore, children should be kept away.

⚠ CAUTION

DO NOT store items of interest to children over the unit. Children climbing to reach items could be seriously injured.

Before Using Range



All products are wiped clean with solvents at the factory to remove any visible signs of dirt, oil, and grease which may have remained from the manufacturing process. Before starting to cook, clean the range thoroughly with hot, soapy water. There may be some burn off and odors on first use of the appliance—this is normal.

Oven

Important! Before first use, wipe interior with soapy water and dry thoroughly. Then set the oven selector to bake, the thermostat to 450°F, and operate for an hour.

Before Using Range

All VGR Gas models include:

- **Exclusive** restaurant style sealed burner system for commercial-type performance.
 - Front burners rated at 23,000 BTUs
 - Back burners rated at 15,000 BTUs / one at 8,000 BTUs.
- **Exclusive** VariSimmer™ setting for all burners provides gentle, even simmering.
- **Exclusive** SureSpark™ ignition system with automatic re-ignition for consistent and reliable ignition on all burners.
- **Exclusive** one-piece tooled and porcelainized cooking surface contains spills for easy cleaning.
- Five performance modes—including convection baking and convection broiling—providing air circulation for shorter cooking times with even results.
- Convection baking with a hidden 30,000 BTU burner provides fast, even baking for all your casserole dishes as well as easy cleanup.
- The 1500°F closed door, infrared broiler allows intense heat to sear delicate cuts of meat providing that restaurant taste.
- Two halogen lights illuminate the oven cavity with less glare.
- Six rack positions and three racks provide ample space for your baking needs.

Before Using Range

All VDR Dual Fuel models include:

- **Exclusive** restaurant style sealed burner system for commercial-type performance.
 - Front burners rated at 23,000 BTUs
 - Back burners rated at 15,000 BTUs / one at 8,000 BTUs
- **Exclusive** VariSimmer™ setting for all burners provides gentle, even simmering.
- **Exclusive** SureSpark™ ignition system with automatic re-ignition for consistent and reliable ignition on all burners.
- **Exclusive** one-piece tooled and porcelainized cooking surface contains spills for easy cleaning.
- Split baking and broiling elements—which reduces preheating time and provides greater control and more even heating.
- A reversing convection fan which is two times larger than most on the market—this allows you to cook foods more thoroughly and evenly—even when baking large quantities.
- Four convection modes offering greater air circulation to shorten cooking times and cook foods more evenly.
- Three broiling modes including a new low-broil mode for delicate broiling and top-browning.
- A profiled, concealed bake element for easier cleaning.

Range Features (VGR Gas Range)

Range Features (VGR Gas Range)

Product Controls

Product Controls

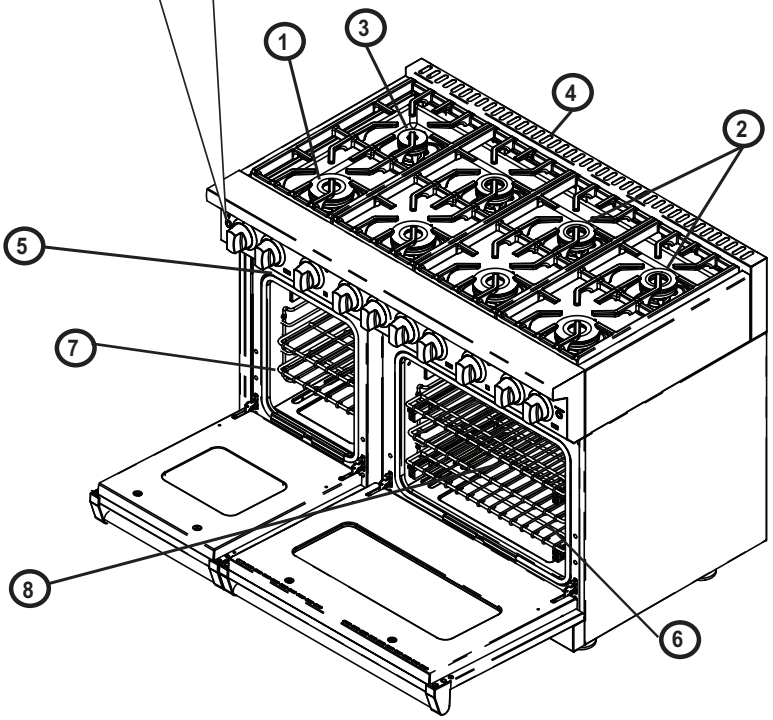
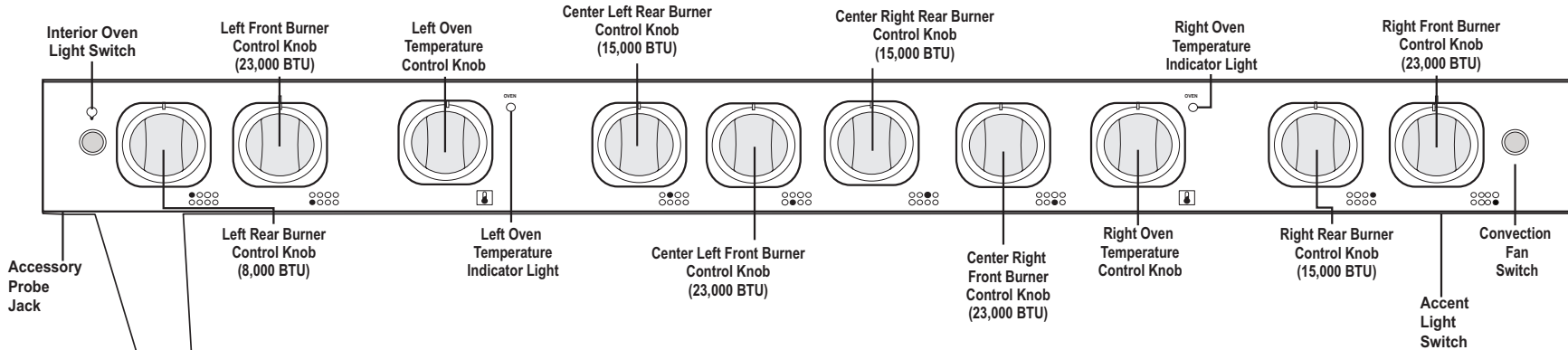

1. Front 23,000 BTU burners
2. Rear 15,000 BTU burners
3. Rear 8,000 BTU burner
4. Island trim
5. Identification plate (under control panel)
6. 30" Oven - Two TruGlide racks/ One standard tilt-proof rack/Six rack positions
7. 18" Oven - Two standard tilt-proof rack/Six rack positions
8. Broiler pan-located inside oven

Range Features (VDR Dual Fuel Range)

Range Features (VDR Dual Fuel Range)

Product Controls

Product Controls

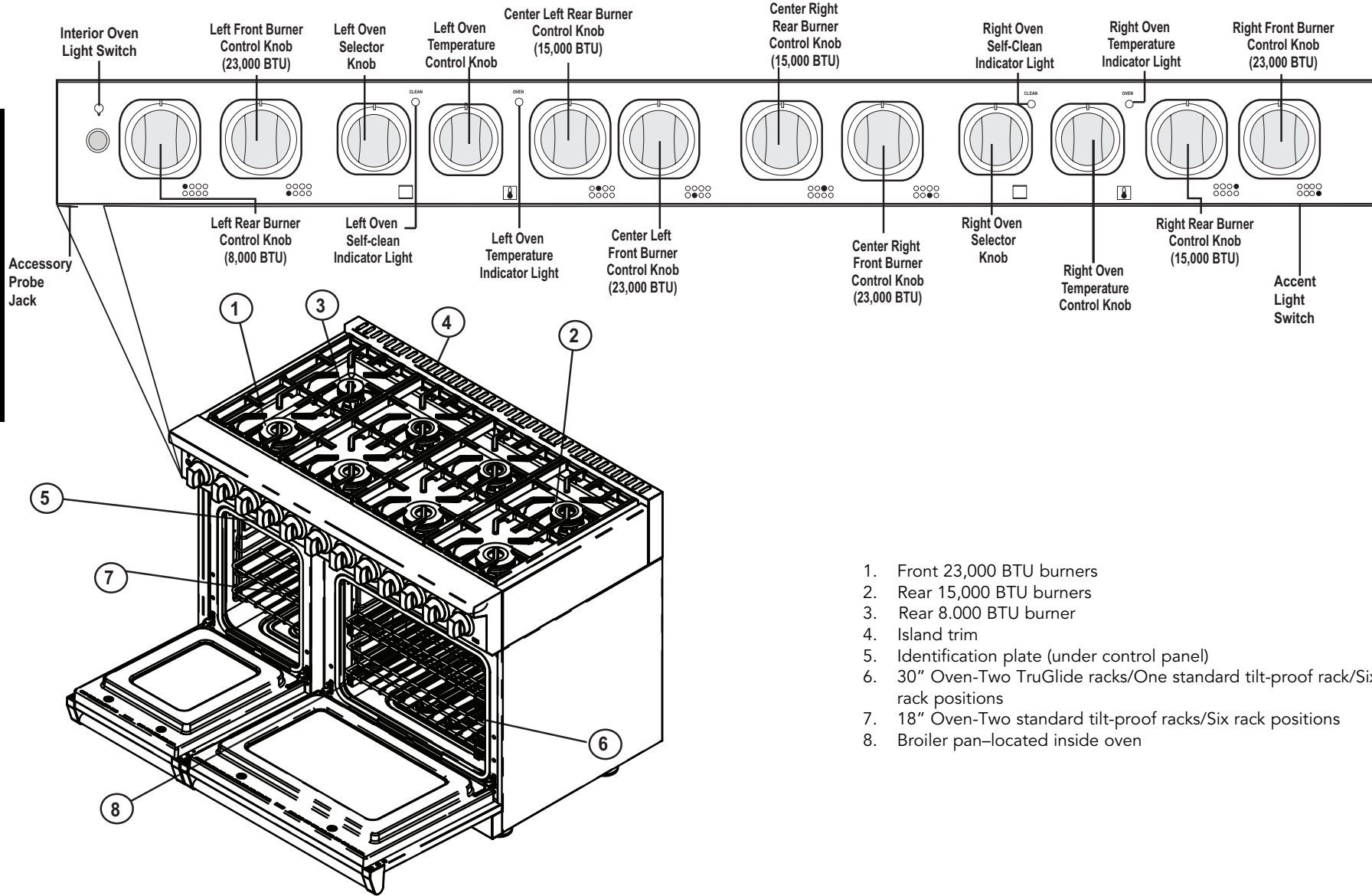

Oven Functions and Settings

VGR Gas Models

BAKE (Natural Airflow Bake)

Use this setting for baking, roasting, and casseroles.

CONVECTION BAKE

Use this setting to bake and roast foods at the same time with minimal taste transfer.

BROIL (Infrared Broil)

Use this setting for broiling dark meats at 1" thickness or less where rare or medium doneness is desired.

CONVECTION BROIL (Infrared Convection Broil)

Use this setting to broil thick cuts of meat.

Convection Dehydrate (CONVECTION BAKE)

Use this function to dehydrate fruits and vegetables.

Convection Defrost (CONVECTION BAKE)

Use this function to defrost foods.

Note: For more information on oven functions see "Operation" section.

Oven Functions and Settings

VDR Dual Fuel Models

BAKE (Two-Element Bake)

Use this setting for baking, roasting, and casseroles.

CONV BAKE (Convection Bake)

Use this setting to bake and roast foods at the same time with minimal taste transfer.

TRU CONV (TruConvect™)

Use this bake setting for multi-rack baking for breads, cakes, cookies

CONV ROAST (Convection Roast)

Use this setting for roasting whole turkeys, whole chickens, hams, etc.

CONV BROIL (Convection Broil)

Use this setting to broil thick cuts of meat.

HI BROIL

Use this setting for broiling dark meats at 1" thickness or less where rare or medium doneness is desired.

MED BROIL

Use this setting for broiling white meats such as chicken or meats greater than 1" thick that would be over-browned in high broil.

LOW BROIL

Use this setting for delicate broiling such as meringue.

SELF CLEAN

Use this function to clean oven.

Convection Dehydration (TRU CONV)

Use this function to dehydrate fruits and vegetables.

Convection Defrost (TRU CONV)

Use this function to defrost foods.

Proof (Left oven on 48"W. models)

Use this setting to allow yeast dough to rise.

Note: For more information on oven functions see "Operation" section.

Surface Operation

Our ranges are equipped with an exclusive restaurant style sealed burner system. This unique burner system is equipped with 23,000 BTU front burners, 15,000 BTU rear burners and one 8,000 rear burner.

The 23,000 BTU burners are designed to provide extra high heat output, especially when using large pans, and should be used for boiling large quantities or if you need to bring something to a boil quickly. While the high output 23,000 BTU burners have the extra power needed to bring large quantities of liquid to a boil rapidly, they are also able to be turned down low enough to provide a very low and delicate simmer making this the most versatile burner system on the market.

Lighting Burners

All burners are ignited by electric ignition. There are no open-flame, "standing" pilots.

Surface Burners-Automatic Reignition

To light the surface burners, push and turn the appropriate control knob counter clockwise to any position. This control is both a gas valve and an electric switch. Burners will ignite at any "ON" position with the automatic re-ignition system. If the flame goes out for any reason, the burners will automatically reignite if the gas is still flowing. When gas is permitted to flow to the burners, the electric igniters start sparking. On all surface igniters you should hear a "clicking" sound. If you do not, turn off the control and check that the unit is plugged in and that the fuse or circuit breaker is not blown or tripped.

Within a few moments, enough gas will have traveled to the burner to light. When the burner lights, turn the burner control to any position to adjust the flame size. Setting the proper flame height for the desired cooking process and selecting the correct cooking vessel will result in superior cooking performance, while also saving time and energy.



Surface Operation

Vari-Simmer™

Simmering is a cooking technique in which foods are cooked in hot liquids kept at or just barely below the boiling point of water. Simmering ensures gentler treatment than boiling to prevent food from toughening and/or breaking up. The size of the pan and the volume of food can have a significant effect on how high or low a flame is needed for simmering. For this reason, Viking range and rangetop burners are engineered with a Vari-Simmer setting. The Vari-Simmer setting is not just one simmer setting, but provides a variable range of simmer settings. This variable range of simmer settings allows you to adjust the flame height to achieve the best simmer depending on the type and quantity of food being simmered. It is this ability that makes the Vari-Simmer setting the most accurate and trustworthy simmer on the market.

Surface Cooking Tips

- Use low or medium flame heights when cooking in vessels that are poor conductors of heat, such as glass, ceramic, and cast-iron. Reduce the flame height until it covers approximately 1/3 of the cooking vessel diameter. This will ensure more even heating within the cooking vessel and reduce the likelihood of burning or scorching the food.
- Reduce the flame if it is extending beyond the bottom of the cooking vessel. A flame that extends along the sides of the vessel is potentially dangerous, heats the utensil handle and kitchen instead of the food, and wastes energy.
- Reduce the flame height to the minimum level necessary to perform the desired cooking process. Remember that food cooks just as quickly at a gentle boil as it does at a rolling boil. Maintaining a higher boil than is necessary wastes energy, cooks away moisture, and causes a loss in food flavor and nutrient level.
- The minimum pot or pan (vessel) diameter recommended is 6" (15 cm). Use of pots or pans as small as 4" (10 cm) is possible but not recommended.

Surface Operation

Griddle/Simmer Plate (on applicable models)

Surface Heat Settings*

Heat Setting	Use
Simmer	Melting small quantities Steaming rice Simmering sauces
Low	Melting large quantities
Med Low	Low-temperature frying (eggs, etc.) Simmering large quantities Heating milk, cream sauces, gravies, and puddings
Med	Sauteing and browning, braising, and pan-frying Maintaining slow boil on large quantities
Med High	High-temperature frying Pan broiling Maintaining fast boil on large quantities
High	Boiling water quickly Deep-fat frying in large utensil

***Note:** The above information is given as a guide only. You may need to vary the heat settings to suit your personal requirements.

Cooking Vessels

Each cook has his or her own preference for the particular cooking vessels that are most appropriate for the type of cooking being done. Any and all cooking vessels are suitable for use in the range and it is not necessary to replace your present domestic vessels with commercial cookware. This is a matter of personal choice. As with any cookware, yours should be in good condition and free from excessive dents on the bottom to provide maximum performance and convenience.



Note: When using big pots and/or high flames, it is recommended to use the front burners. There is more room in the front and potential cleanup at rear of appliance due to staining or discoloration will be minimized.

The optional 15,000 BTU griddle is constructed of machined steel with a chrome finish and is uniquely designed to offer excellent cooking performance as well as easy clean up. The griddle is equipped with an electronic thermostat to maintain an even temperature across the griddle once the desired temperature has been set. The griddle has a power "ON" indicator light which glows when the griddle thermostat has been turned on. This will cycle on and off as needed to indicate the thermostat is maintaining the selected temperature.

Cleaning the Griddle before the First Use

- Remove plastic film
- Wash griddle with warm, soapy water. Rinse off and dry thoroughly. The griddle is now ready to be used.

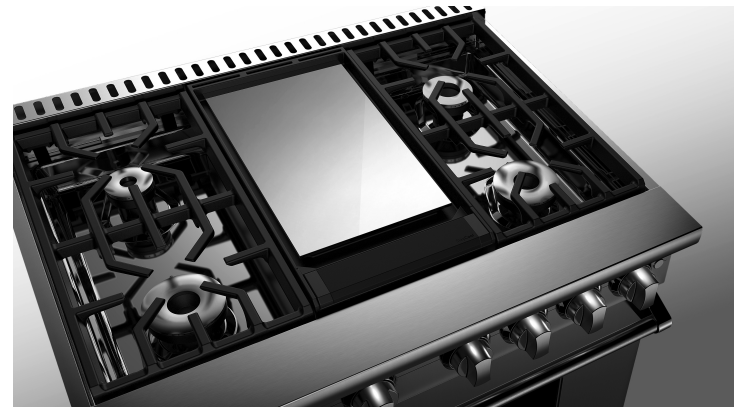

Griddle Cooking Chart

Food	Temp (°F)	Temp (°C)
Eggs	200	93
Bacon	300-325	149-163
Pancakes	375-400	191-205
French Toast	400	205
Fish Fillets	250	121
Hamburger	350	177
Steaks	350	177

***Note:** The above information is given as a guide only. You may need to vary the heat settings to suit your personal requirements.

Griddle/Simmer Plate

(on applicable models)

Griddle/Simmer Plate Operation

- Turn the griddle control knob counterclockwise to the desired temperature setting. The power "ON" indicator light will glow indicating the griddle thermostat is on.
- When the griddle has reached the desired temperature, the power "ON" indicator light will turn off indicating the griddle is preheated to the selected temperature.
- Use liquid cooking oil or butter for eggs, pancakes, French toast, fish and sandwiches to prevent sticking.
- Routinely scrape loose food particles with a heat resistant plastic or wooden spatula during cooking to make the cleanup easier and to avoid the particles mixing with the food.
- To turn the griddle off, turn the thermostat knob clockwise to the "OFF" position.
- ALWAYS turn to the "OFF" position when not in use and lower the heat between cooking loads.

Note: On griddle model ranges, the griddle/simmer plate will not function during the self-clean cycle.

Griddle/Simmer Plate Clean Up & Care

- AFTER the griddle has cooled, simply wipe down the surface with a clean cloth or paper towel. The chrome griddle plate can then be removed and taken to the sink for easy cleanup.
- After heavy cooking is completed and the griddle is still warm enough to create steam, pour a small amount of club soda at room temperature directly on the griddle. Using a heat resistant or wooden spatula, pull oils and food particles toward the trough in front. Wipe entire surface with a paper towel.
- Non-stick cooking spray is not recommended as it contains a high water content that has a tendency to burn quickly.
- Corn oil is not recommended as it has a high sugar level. It will caramelize and burn on the surface making it very difficult to remove.
- After using the griddle, always remove the grease trough located in the front. Simply pull the trough towards you and lift out. The trough or tray trap needs to be cleaned after each use. A fire hazard may occur if grease is accumulated in the trough.
- Important: Never flood a hot griddle with cold water. This thermal shock promotes griddle warping and can cause the griddle to crack if continued over a period of time.

CAUTION: Chrome griddle plate is **Not** Dishwasher Safe
Optional Nonstick griddle/grill accessory plate is available for purchase

Oven Features

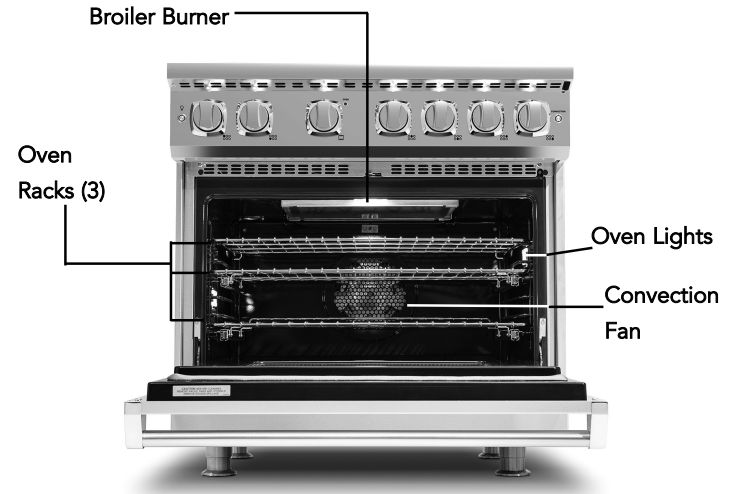

Gentle Close Door Feature

All oven doors come standard with a gentle close feature. The door will remain in an open position until the door is approximately 5" (12.7 cm) away from the oven. When reaching this point, the door will require a slight push to engage the gentle close mechanism. The closing speed of the door will vary according to the oven temperature.

Rack Positions

The 36" W. and 48" W. right-hand oven is equipped with two full extension glide racks and one standard tilt-proof rack. The 18" left-hand oven is equipped with two standard tilt-proof racks. All ovens have six rack positions. Position 6 is the farthest from the oven bottom. Position 1 is the closest to the oven bottom. The racks can be easily removed and arranged at various levels. For best results with conventional baking, **DO NOT** use more than one rack at a time. It is also recommended, when using two racks, to bake with the racks in positions 2 and 4 or positions 3 and 5.

Using the Oven

Conventional and Convection Cooking

Because of variations in food density, surface texture and consistency, some foods may be prepared more successfully using the conventional bake setting. For this reason, conventional baking is recommended when preparing baked goods such as custard. The user may find other foods that are also prepared more consistently in conventional bake. It is recommended to use this function for single-rack baking.

Convection Cooking Tips

Convection cooking is a technique utilizing fan-forced air which is circulated throughout the entire oven cavity creating the optimum cooking environment. Cooking with convection is intended when performing multi-rack baking and for heavier foods. Below are some tips which will allow you to get the best results out of your oven when cooking with convection.

- As a general rule, to convert conventional recipes to convection recipes, reduce the temperature by 25°F (14°C) when using a convection cooking function.
- Cooking times for standard baking and convection baking will be the same. However, if using convection to cook a single item or smaller load, then it is possible to have 10-15% reduction in cooking time. (Remember convection cooking is designed for multi-rack baking or cooking large loads.)
- If cooking items which require longer than 45 minutes, then it is possible to see a 10-15% reduction in cooking time.
- A major benefit of convection cooking is the ability to prepare foods in quantity. The uniform air circulation makes this possible. Foods that can be prepared on two of three racks at the same time include: pizza, cakes, cookies, biscuits, muffins, rolls, and frozen convenience foods.
- For three-rack baking, use any combination of rack positions 2, 3, 4, and 5. For two-rack baking, use rack positions 2 and 4 or positions 3 and 5. Remember that the racks are numbered from bottom to top.

Baking

VGR Gas Ranges

BAKE

(Natural Airflow Bake)

Full power heat is radiated from the bake burners in the bottom of the oven cavity and is circulated with natural airflow.

This function is recommended for single rack baking. Many cookbooks contain recipes to be cooked in the conventional manner. Conventional baking is suitable for dishes that require a high temperature. Use this setting for baking and casseroles.

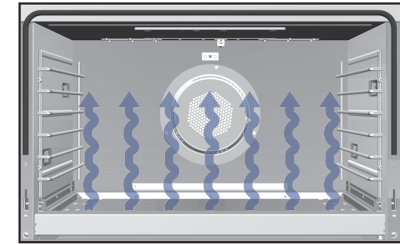

To Use BAKE Function

1. Arrange the oven rack in the desired position before turning oven on.
2. Close the door.
3. Set the oven temperature control knob to desired temperature.

CONVECTION BAKE

Heat is radiated from the U-shaped bake burners in the bottom of the oven cavity. The heated air is circulated by one motorized fan in the rear of the oven providing a more even heat distribution. Multiple rack use is possible for the largest baking job. When roasting, cool air is quickly replaced—searing meats on the outside and retaining more juices and natural flavor on the inside with less shrinkage. This even circulation of air equalizes the temperature throughout the oven cavity and eliminates the hot and cold spots found in conventional ovens.

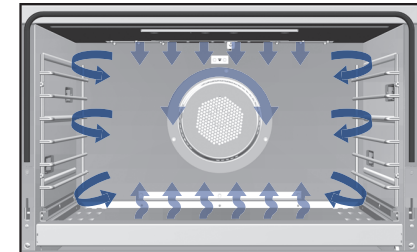

To Use CONVECTION BAKE Function

1. Arrange the oven rack in the desired position before turning oven on.
2. Close the door.
3. Set the oven temperature control knob to desired temperature and turn on the convection fan switch.

Baking

VDR Dual Fuel Ranges

BAKE (Two-Element Bake)

Full power heat is radiated from the bake element in the bottom of the oven cavity and supplemental heat is radiated from the broil element. This function is recommended for single rack baking. Many cookbooks contain recipes to be cooked in the conventional manner. Conventional baking/roasting is particularly suitable for dishes that require a high temperature. Use this setting for baking, roasting, and casseroles.

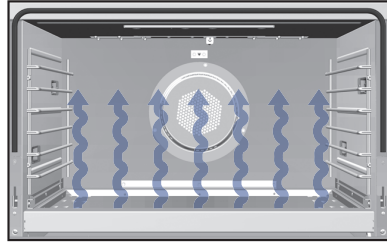

To Use BAKE Function

1. Arrange the oven rack in the desired position before turning oven on.
2. Close the door.
3. Set the oven function selector to "BAKE" and oven temperature control knob to desired temperature.

CONV BAKE (Convection Bake)

The bottom element operates at full power, and the top broil element operates at supplemental power. The heated air is circulated by the motorized fan in the rear of the oven providing a more even heat distribution. This even circulation of air equalizes the temperature throughout the oven cavity and eliminates the hot and cold spots found in conventional ovens. A major benefit of convection baking is the ability to prepare food in quantity using multiple racks—a feature not possible in a standard oven.

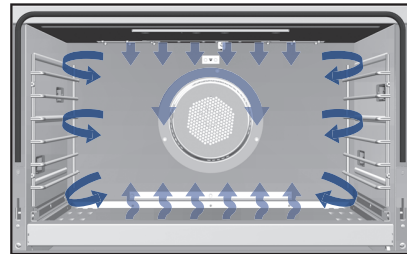

When roasting using this setting, cool air is quickly replaced, searing meats on the outside and retaining more juices and natural flavor on the inside with less shrinkage. With this heating method, foods can be baked and roasted at the same time with minimal taste transfer, even when different dishes are involved, such as cakes, fish or meat. The hot air system is especially economical when thawing frozen food.

Baking

To Use CONV BAKE Function

1. Arrange the oven rack in the desired position before turning oven on.
2. Close the door.
3. Set the oven function selector to "CONV BAKE" and the oven temperature control knob to desired temperature.

TRU CONV (TruConvect™)

The rear element only operates at full power. There is no direct heat from the bottom or top elements. The motorized fan in the rear of the oven circulates air in the oven cavity for even heating. Use this setting for foods that require gentle cooking such as pastries, souffles, yeast breads, quick breads and cakes. Breads, cookies, and other baked goods come out evenly textured with golden crusts. No special bakeware is required. Use this function for single rack baking, multiple rack baking, roasting, and preparation of complete meals. This setting is also recommended when baking large quantities of baked goods at one time.

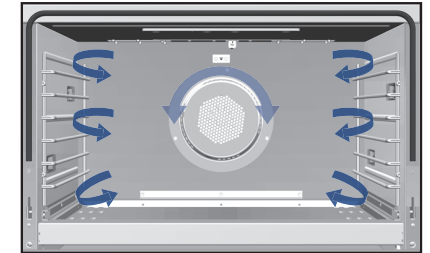

To Use TRU CONV Function

1. Arrange the oven rack in the desired position before turning oven on.
2. Close the door.
3. Set the oven function selector to "TRU CONV" and the oven temperature control knob to desired temperature.

Baking

Baking Tips

- Make sure the oven racks are in the desired position before you turn on the oven.
- **DO NOT** open the door frequently during baking. Look through the door window to check doneness whenever possible. If you must open the door, the best time is during the last quarter of the baking time.
- Bake to the shortest time suggested and check for doneness before adding more time. For baked goods, a stainless steel knife placed in the center of the product should come out clean when done.
- Use the pan size and type recommended by the recipe to ensure best results. Cakes, quick breads, muffins, and cookies should be baked in shiny, reflective pans for light, golden crusts. Avoid the use of old, darkened pans. Warped, dented, stainless steel and tin-coated pans heat unevenly and will not give uniform baking results.

Pan Placement Tips

- When using large (15" x 13") flat pans or trays that cover most of the rack, rack positions 2 or 3 produce the best results.
- When baking on more than one rack, it is recommended to use the 3rd and 5th position for more consistent even baking.
- Stagger pans in opposite directions when two racks and several pans are used in conventional bake. If possible, no pan should be directly above another.
- Allow 1 to 2 inches of air space around all sides of each pan for even air circulation.

Single Rack Pan Placement

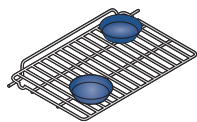

Multiple Rack Pan Placement

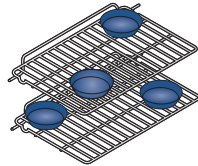

Baking

Conventional Baking Chart

Food	Pan Size	Single Rack Position	Temp	Time (min)
BREADS				
Biscuits	Cookie sheet	3 or 4	400° F (204° C)	10 - 12
Yeast loaf	Loaf pan	3 or 4	375° F (191° C)	30 - 35
Yeast rolls	Cookie sheet	3 or 4	400° F (204° C)	12 - 15
Nut bread	Loaf pan	3 or 4	375° F (191° C)	30 - 35
Combread	8" x 8"	3 or 4	400° F (204° C)	25 - 30
Gingerbread	8" x 8"	3 or 4	350° F (177° C)	35 - 40
Muffins	Muffin tin	3 or 4	375° F (191° C)	15 - 20
Corn muffins	Muffin tin	3 or 4	375° F (191° C)	15 - 20
CAKES				
Angel food	Tube pan	3 or 4	375° F (191° C)	35 - 45
Bundt	Tube pan	3 or 4	350° F (177° C)	45 - 55
Cupcakes	Muffin pan	3 or 4	350° F (177° C)	16 - 20
Layer, sheet	13" x 9"	3 or 4	350° F (177° C)	40 - 50
Layer, two	9" round	3 or 4	350° F (177° C)	30 - 35
Pound	Loaf pan	3 or 4	350° F (177° C)	60 - 65
COOKIES				
Brownies	13" x 9"	3 or 4	350° F (177° C)	25 - 30
Choc. chip	Cookie sheet	3 or 4	375° F (191° C)	12 - 15
Sugar	Cookie sheet	3 or 4	375° F (191° C)	10 - 12
PASTRY				
Cream puffs	Cookie sheet	3 or 4	400° F (204° C)	30 - 35
PIES				
Crust, unfilled	9" round	3 or 4	400° F (204° C)	10 - 12
Crust, filled	9" round	3 or 4	350° F (191° C)	55 - 60
Lemon meringue	9" round	3 or 4	350° F (177° C)	12 - 15
Pumpkin	9" round	3 or 4	350° F (177° C)	35 - 40
Custard	6 - 4 oz cups	3 or 4	350° F (177° C)	35 - 40
ENTREES				
Egg rolls	Cookie sheet	3 or 4	400° F (204° C)	25 - 30
Fish sticks	Cookie sheet	3 or 4	425° F (218° C)	10 - 15
Lasagna, frz	Cookie sheet	3 or 4	375° F (191° C)	55 - 60
Pot pie	Cookie sheet	3 or 4	400° F (204° C)	35 - 40
Gr. peppers stuffed	13" x 9"	3 or 4	375° F (191° C)	60 - 70
Quiche	9" round	3 or 4	400° F (204° C)	25 - 30
Pizza, 12"	Cookie sheet	3 or 4	400° F (204° C)	15 - 20
Mac. & cheese, frz	Cookie sheet	3 or 4	375° F (191° C)	35 - 40
VEGETABLES				
Baked potatoes	On rack	3 or 4	375° F (191° C)	60 - 65
Spinach souffle	1 qt. casserole	3 or 4	350° F (177° C)	45 - 50

***Note:** The above information is given as a guide only.

Baking

Convection Baking Chart

Food	Pan Size	Single Rack Position	Temp	Time (min)
BREADS				
Frozen Biscuits	Cookie sheet	3 or 4	375° F (191° C)	7 - 9
Yeast loaf	Loaf pan	3 or 4	375° F (191° C)	25 - 30
Yeast rolls	Cookie sheet	3 or 4	375° F (191° C)	11 - 13
Nut bread	Loaf pan	3 or 4	350° F (177° C)	25 - 30
Combread	8" x 8"	3 or 4	375° F (191° C)	20 - 25
Gingerbread	8" x 8"	3 or 4	325° F (163° C)	30 - 35
Muffins	Muffin tin	3 or 4	350° F (177° C)	12 - 15
Corn muffins	Muffin tin	3 or 4	350° F (177° C)	10 - 12
CAKES				
Angel food	Tube pan	3 or 4	350° F (177° C)	35 - 40
Bundt	Tube pan	3 or 4	325° F (163° C)	35 - 40
Cupcakes	Muffin pan	3 or 4	325° F (163° C)	15 - 17
Layer, sheet	13" x 9"	3 or 4	325° F (163° C)	30 - 35
Layer, two	9" round	3 or 4	325° F (163° C)	25 - 30
Pound	Loaf pan	3 or 4	325° F (163° C)	45 - 50
COOKIES				
Brownies	13" x 9"	3 or 4	325° F (163° C)	20 - 25
Choc. chip	Cookie sheet	3 or 4	350° F (177° C)	7 - 10
Sugar	Cookie sheet	3 or 4	350° F (177° C)	7 - 10
PIES				
Crust, unfilled	9" round	3 or 4	375° F (191° C)	7 - 9
Crust, filled	9" round	3 or 4	325° F (163° C)	50 - 55
Lemon meringue	9" round	3 or 4	325° F (163° C)	10 - 12
Pumpkin	9" round	3 or 4	325° F (163° C)	45 - 55
Custard	Not recommended			
ENTREES				
Egg rolls	Cookie sheet	3 or 4	375° F (191° C)	15 - 20
Fish sticks	Cookie sheet	3 or 4	400° F (205° C)	8 - 10
Lasagna, frz	Cookie sheet	3 or 4	350° F (177° C)	45 - 50
Pot pie	Cookie sheet	3 or 4	375° F (191° C)	35 - 40
Gr. peppers stuffed	13" x 9"	3 or 4	350° F (177° C)	45 - 50
Quiche	Not recommended			
Pizza, 12"	Cookie sheet	3 or 4	375° F (191° C)	15 - 20
Mac. & cheese, frz	Cookie sheet	3 or 4	350° F (177° C)	25 - 35
VEGETABLES				
Baked potatoes	On rack	3 or 4	350° F (177° C)	50 - 55
Spinach souffle	1 qt. casserole	3 or 4	325° F (163° C)	35 - 40
Squash	Cookie sheet	3 or 4	350° F (177° C)	40 - 45

***Note:** The above information is given as a guide only.

Baking

Solving Baking Problems

Baking problems can occur for many reasons. Check the chart below for the causes and remedies for the most common problems. It is important to remember that the temperature setting and cooking times you are accustomed to using with your previous oven may vary slightly from those required with this oven. If you find this to be true, it is necessary for you to adjust your recipes and cooking times accordingly.

Common Baking Problems/Remedies

Problems	Cause	Remedy
Cakes burned on the sides or not done in center	1. Oven was too hot 2. Wrong pan size 3. Too many pans	1. Reduce temperature 2. Use recom. pan size 3. Reduce no. of pans
Cakes crack on top	1. Batter too thick 2. Oven too hot 3. Wrong pan size	1. Follow recipe Add liquid 2. Reduce temperature 3. Use recom. pan size
Cakes are not level	1. Batter uneven 2. Oven or rack not level 3. Pan was warped	1. Distribute batter even 2. Level oven or rack 3. Use proper pan
Food too brown on bottom	1. Oven door opened too often 2. Dark pans being used 3. Incorrect rack position 4. Wrong bake setting 5. Pan too large	1. Use door window to check food 2. Use shiny pans 3. Use recom. rack position 4. Adjust to conventional or convection setting as needed 5. Use proper pan
Food too brown on top	1. Rack position too high 2. Oven not preheated 3. Sides of pan too high	1. Use recom. rack position 2. Allow oven to preheat 3. Use proper pans
Cookies too flat	1. Hot cookie sheet	1. Allow sheet to cool between batches
Pies burned around edges	1. Oven too hot 2. Too many pans used 3. Oven not preheated	1. Reduce temperature 2. Reduce no. of pans 3. Allow oven to preheat
Pies too light on top	1. Oven not hot enough 2. Too many pans used 3. Oven not preheated	1. Increase temperature 2. Reduce no. of pans 3. Allow oven to preheat

Roasting (VDR Dual Fuel Models)

CONV ROAST* (Convection Roast)

The convection element runs in conjunction with the inner and outer broil elements. The reversible convection fan runs at a higher speed in each direction. This transfer of heat (mainly from the convection element) seals moisture inside of large roasts. A time savings is gained over existing, single fan convection roast modes. Use this setting for whole turkeys, whole chickens, hams, etc.

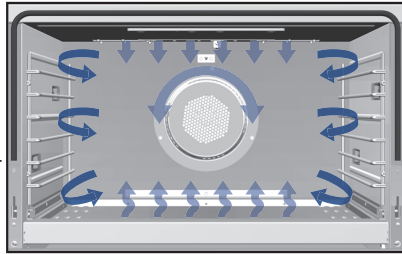

***Note:** This function uses a high-speed convection fan for optimum cooking performance. Some noise may be noticed from this high fan speed. This is normal.

Note: You can also roast foods using bake settings. See the "Baking" section for additional information.

Roasting Tips

ALWAYS use the broiler pan and grid supplied with each oven. The hot air must be allowed to circulate around the item being roasted.

DO NOT cover what is being roasted. Convection roasting seals in juices quickly for a moist, tender product. Poultry will have a light, crispy skin and meats will be browned, not dry or burned. Cook meats and poultry directly from the refrigerator. There is no need for meat or poultry to stand at room temperature.

- As a general rule, to convert conventional recipes to convection recipes, reduce the temperature by 25°F (14°C) and the cooking time by approximately 10 to 15%.
- **ALWAYS** roast meats fat side up in a shallow pan using a roasting rack. No basting is required when the fat side is up. **DO NOT** add water to the pan as this will cause a steamed effect. Roasting is a dry heat process.
- Poultry should be placed breast side up on a rack in a shallow pan. Brush poultry with melted butter, margarine, or oil before and during roasting.
- For convection roasting, **DO NOT** use pans with tall sides as this will interfere with the circulation of heated air over the food.
- If using a cooking bag, foil tent, or other cover, use the conventional bake setting rather than either convection setting.

Roasting (VDR Dual Fuel Models)

Roasting Tips (cont.)

- When using a meat thermometer, insert the probe halfway into the center of the thickest portion of the meat. (For poultry insert the thermometer probe between the body and leg into the thickest part of the inner thigh.) The tip of the probe should not touch bone, fat, or gristle to ensure an accurate reading. Check the meat temperature halfway through the recommended roasting time. After reading the thermometer once, insert it ½ inch (1.3 cm) further into the meat, then take a second reading. If the second temperature registers below the first, continue cooking the meat.
- Roasting times **ALWAYS** vary according to the size, shape and quality of meats and poultry. Less tender cuts of meat are best prepared in the conventional bake setting and may require moist cooking techniques. Remove roasted meats from the oven when the thermometer registers 5°F (3°C) to 10° F (6°C) lower than the desired doneness. The meat will continue to cook after removal from the oven. Allow roasts to stand 15 to 20 minutes after roasting in order to make carving easier.

Roasting (VDR Dual Fuel Models)

Roasting (VDR Dual Fuel Models)

Conventional Roasting Chart
(when using the Bake or Convection Bake setting)

Food	Weight	Temp	Time (min/lb)	Internal Temp
BEEF				
Rib roast				
Rare	4 - 6 lbs	325° F (162.8° C)	25	140° F (60.0° C)
Medium	4 - 6 lbs	325° F (162.8° C)	30	155° F (68.3° C)
Well done	4 - 6 lbs	325° F (162.8° C)	40	170° F (76.7° C)
Rump roast				
Medium	4 - 6 lbs	325° F (162.8° C)	25	155° F (68.3° C)
Well done	4 - 6 lbs	325° F (162.8° C)	30	170° F (76.7° C)
Tip roast				
Medium	3 - 4 lbs	325° F (162.8° C)	35	155° F (68.3° C)
Well done	3 - 4 lbs	325° F (162.8° C)	40	170° F (76.7° C)
LAMB				
Lamb leg	3 - 5 lbs	325° F (162.8° C)	30	180° F (82.2° C)
PORK				
Pork loin	3 - 5 lbs	325° F (162.8° C)	35	180° F (82.2° C)
Pork chops 1" thick	1 - 1 1/4 lbs	350° F (176.7° C)	55 - 60 total time	N/A
Ham, fully cooked	5 lbs	325° F (162.8° C)	18	130° F (54.4° C)
POULTRY				
Chicken, whole	3 - 4 lbs	375° F (190.6° C)	30	180° F (82.2° C)
Turkey, unstuffed	12 - 16 lbs	325° F (162.8° C)	16 - 20	180° F (82.2° C)
Turkey	20 - 24 lbs	325° F (162.8° C)	16 - 20	180° F (82.2° C)
Turkey, stuffed	12 - 16 lbs	325° F (162.8° C)	17 - 21	180° F (82.2° C)
Turkey, stuffed	20 - 24 lbs	325° F (162.8° C)	17 - 21	180° F (82.2° C)
Turkey breast	4 - 6 lbs	325° F (162.8° C)	20	180° F (82.2° C)

Note: The above information is given as a guide only.

Convection Roasting Chart

Food	Weight	Temp	Time (min/lb)	Internal Temp
BEEF				
Rib roast				
Rare	4 - 6 lbs	325° F (162.8° C)	25	140° F (60.0° C)
Medium	4 - 6 lbs	325° F (162.8° C)	24	155° F (68.3° C)
Well done	4 - 6 lbs	325° F (162.8° C)	30	170° F (76.7° C)
Rump roast				
Medium	4 - 6 lbs	325° F (162.8° C)	20	155° F (68.3° C)
Well done	4 - 6 lbs	325° F (162.8° C)	24	170° F (76.7° C)
Tip roast				
Medium	3 - 4 lbs	325° F (162.8° C)	30	155° F (68.3° C)
Well done	3 - 4 lbs	325° F (162.8° C)	35	170° F (76.7° C)
LAMB				
Lamb leg	3 - 5 lbs	325° F (162.8° C)	30	180° F (82.2° C)
PORK				
Pork loin	3 - 5 lbs	325° F (162.8° C)	30	180° F (82.2° C)
Pork chops 1" thick	1 - 1 1/4 lbs	325° F (162.8° C)	45 - 50 total time	N/A
Ham, fully cooked	5 lbs	325° F (162.8° C)	15	130° F (54.4° C)
POULTRY				
Chicken, whole	3-4 lbs	350 (176.7 C)	25	180° F (82.2° C)
Turkey, unstuffed	12 - 16 lbs	325° F (162.8° C)	11	180° F (82.2° C)
Turkey	20 - 24 lbs	325° F (162.8° C)	11	180° F (82.2° C)
Turkey, stuffed	12 - 16 lbs	325° F (162.8° C)	9 - 10	180° F (82.2° C)
Turkey, stuffed	20 - 24 lbs	325° F (162.8° C)	9 - 10	180° F (82.2° C)
Turkey breast	4 - 6 lbs	325° F (162.8° C)	20	180° F (82.2° C)

Note: The above information is given as a guide only.

Kitchen Thermometer Accessory

An iDevices® Kitchen Thermometer is shipped standard with each 7 Series Range. Working in conjunction with the included meat probe, wireless Apple/Android devices can monitor the Kitchen Accessory from up to 200 feet away using Bluetooth® technology; perfect for baking and roasting so there is no worry about undercooking.

A full user guide is available inside the iDevices Connected app and online at iDevicesinc.com.

Quick Start Instructions

- Download the iDevices Connected app and launch from your smart device.
- Separate the Kitchen Thermometer from its base by firmly holding the base with one hand and gently pulling the Kitchen Thermometer upwards with the other hand.
- On the underside of the thermometer, depress and remove the battery door. Insert the two supplied AA batteries.
- Clip the thermometer back into its base.
- Plug the thermometer probes into the probe ports.
- Using the connector cable packed inside the range, plug the kitchen thermometer into the accessory probe jack located on the left hand side of the range underneath the landing ledge.

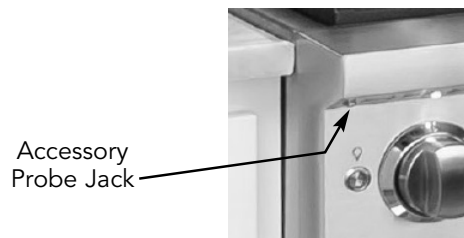

- Insert the meat probe packed inside the range into the meat and place in the oven. Plug the probe into the outlet located on the left interior wall of the oven and close the door. **(NOTE: 48" W. Ranges only have a probe outlet in the large right-hand oven.)**
- Press the kitchen thermometer power button located at the bottom of the faceplate between the < and > buttons. The 7-segment display will animate and a single beep will sound, indicating the device has powered on.

Kitchen Thermometer Accessory

Kitchen Thermometer Display

The kitchen thermometer's display contains the following:

7-Segment Display

- Display temperature of currently active probe.
- Displays "DC" for temperatures below set range or below -22°F.
- Displays "DH" for temperatures above set range or above 572°F.
- Displays "OFF" during power off sequence.
- Animates during power on sequence and during reset.

Bluetooth LED

- Blinks blue when discoverable and awaiting pairing.
- Illuminates solid blue when paired.

Probe Indicator LED's

- Left side LED illuminates to indicated Probe 1 Temperature being displayed.
- Right side LED illuminates to indicated Probe 2 temperature being displayed.

Broiling

Broiling Instructions

Broiling is a dry-heat cooking method using direct or radiant heat. It is used for small, individualized cuts such as steaks, chops, and patties. Broiling speed is determined by the distance between the food and the broil element. Choose the rack position based on desired results.

Conventional broiling is most successful for cuts of meat 1-2 inches thick and is also more suitable for flat pieces of meat. Convection broiling has the advantage of broiling food slightly quicker than conventional. Convection broiling of meats produces better results, especially for thick cuts. The meat sears on the outside and retains more juices and natural flavor inside with less shrinkage.

VGR Gas Ranges

BROIL (Infrared Broil)

The broil burner at the top of the oven heats the metal screen until it glows. Heat radiates from the GourmetGlo™ infrared broiler located at the top of the oven cavity. The distance between the foods and the broil elements determines broiling speed. For "fast" broiling, food may be as close as 2 inches (5 cm) to the broil element. "Fast" broiling is best for meats where rare to medium doneness is desired. Use this setting for broiling small and average cuts of meat.

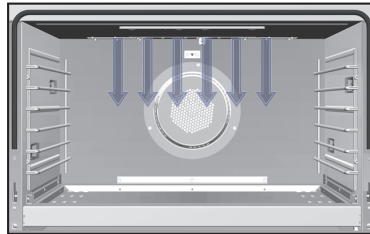

CONVECTION BROIL (Infrared Convection Broil)

The top burner operates at full power. This function is exactly the same as regular broiling with the additional benefit of air circulation by the motorized fan in the rear of the oven. Smoke is reduced since the airflow also reduces peak temperatures on the food. Use this setting for broiling thick cuts of meats.

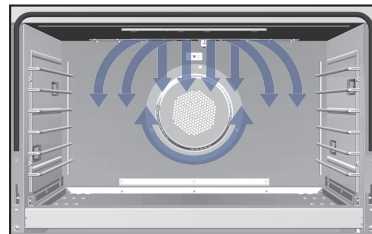

Broiling

To Use Broil or Convection Broil

1. Arrange the oven rack in the desired position before turning broiler on.
2. Center the food on cold broiler pan and grid supplied with your oven. Place broiler pan in oven.
3. Set the oven temperature control knob to "Broil". Turn on the convection fan switch if you wish to convection broil.
4. Close the door. There is not a detent to hold the door in the open broil stop position. With open door broiling the broil element does not cycle on and off and could cause the control panel and knobs to reach a higher than normal temperature. With closed door broiling the broil element might cycle on and off if an extended broiling time is required. A built-in smoke "eliminator" in the top of the oven helps reduce smoke and odors.

VDR Dual Fuel Ranges

CONV BROIL (Convection Broil)*

The top element operates at full power. This function is exactly the same as regular broiling with the additional benefit of air circulation by the motorized fan in the rear of the oven. Smoke is reduced since the airflow also reduces peak temperatures on the food. Use this setting for broiling thick cuts of meats.

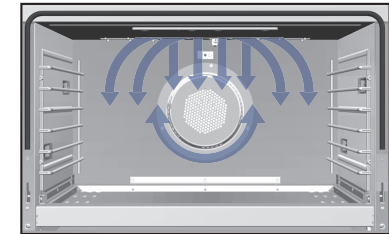

***Note:** This function uses a high-speed convection fan for optimum cooking performance. Some noise may be noticed from this high fan speed. This is normal.

HI BROIL

Heat radiates from both broil elements, located in the top of the oven cavity, at full power. The distance between the foods and the broil elements determines broiling speed. For fast broiling, food may be as close as 2 inches (5 cm) to the broil element. Fast broiling is best for meats where rare to medium doneness is desired. Use this setting for broiling small and average cuts of meat.

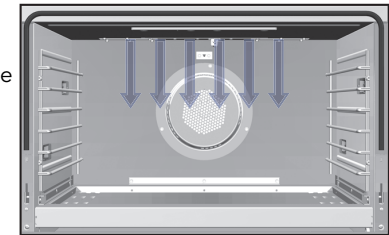

Broiling

MED BROIL

Inner and outer broil elements pulse on and off to produce less heat for slow broiling. Allow about 4 inches (10 cm) between the top surface of the food and the broil element. Slow broiling is best for chicken and ham in order to broil food without over-browning it. Use this setting for broiling small and average cuts of meat.

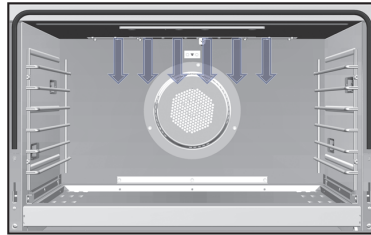

LOW BROIL

This mode uses only a fraction of the available power to the inner broil element for delicate top-browning. The inner broil element is on for only part of the time. Use this setting to gently brown meringue on racks 3 or 4 in 3-4 minutes.

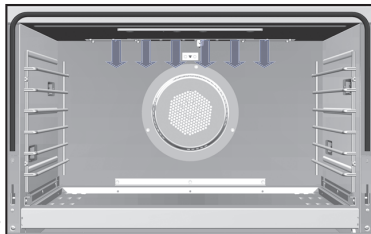

To Use Broil or Convection Broil

1. Arrange the oven rack in the desired position before turning broiler on.
2. Center the food on cold broiler pan and grid supplied with your oven. Place broiler pan in oven.
3. Set the oven function selector to desired broiling function and the temperature control knob to "Broil".
4. Close the door. There is not a detent to hold the door in the open broil stop position. With open door broiling the broil element does not cycle on and off and could cause the control panel and knobs to reach a higher than normal temperature. With closed door broiling the broil element might cycle on and off if an extended broiling time is required. A built-in smoke "eliminator" in the top of the oven helps reduce smoke and odors.

Broiling

Broiling Tips

- **ALWAYS** use a broiler pan and grid for broiling. They are designed to provide drainage of excess liquid and fat away from the cooking surface to help prevent splatter, smoke, and fire.
- To keep meat from curling, slit fatty edge.
- Brush chicken and fish with butter several times as they broil to prevent drying out. To prevent sticking, lightly grease broiler tray.
- Broil on first side for slightly more than half the recommended time, season, and turn. Season second side just before removing.
- **ALWAYS** pull rack out to stop position before turning or removing food.
- Use tongs or a spatula to turn meats. **NEVER** pierce meat with a fork, as this allows the juices to escape.
- Remove the broiler pan from the oven when you remove the food. Drippings will bake onto the pan if it is left in the heated oven after broiling. While pan is hot, place damp paper towel over grid. Drizzle with liquid dishwashing detergent and pour water over grid. This will make cleaning of the pan easier, or the broiler pan can be lined with aluminum foil to make cleaning easier. Be sure the foil extends up the side of the pan. Although it is not recommended, the grid can also be covered with foil. Be sure to slit openings to conform with the openings in the grid so melted fat can drain through to prevent spattering, smoking, or the possibility of grease fire.

Rack Positions for Broiling

Note: Position 6 is the closest to the broiler and position 1 is the closest to the oven bottom.



Broiling

Broiling Chart

Type and Cut of Meat	Weight	Setting	Rack	Time (min)
BEEF				
Sirloin, 1"				
Rare	12 oz	Broil	3	4
Medium	12 oz	Broil	3	5
Well done	12 oz	Broil	3	6
T-Bone, 3/4"				
Rare	10 oz	Broil	3	4
Medium	10 oz	Broil	3	6
Well done	10 oz	Broil	3	8
Hamburger, 1/2"				
Medium	1/4 lb.	Broil	3	6
Well done	1/4 lb.	Broil	3	8
CHICKEN				
Bnls breast, 1"	1/2 lb.	Broil	3	15
Bnls breast, 1"	1/2 lb.	Convection Broil	3	15
Bone-in breast	2 - 3 lbs total	Broil	1	22
Bone-in breast	2 - 3 lbs total	Convection Broil	1	20
Chicken pieces	2 - 3 lbs total	Broil	3	22
Chicken pieces	2 - 3 lbs total	Convection Broil	3	20
HAM				
Ham slice, 1"	1 lb.	Broil	3	10
LAMB				
Rib chops, 1"	12 oz.	Convection Broil	2	8
PORK				
Loin chops, 3/4"	1 lb.	Convection Broil	2	10
Bacon		Broil	2	3
FISH				
Salmon steak	1 lb.	Broil	2	8
Filletts	1 lb.	Broil	2	8

Note: The above information is given as a guide only.

Convection Dehydrate

This oven is designed not only to cook, but also to dehydrate fruits and vegetables. Warm air is circulated by a motorized fan in the rear of the oven and over a period of time, the water is removed from the food by evaporation. Removal of water inhibits growth of microorganisms and retards the activity of enzymes. It is important to remember that dehydration does not improve the quality, so only fresh, top-quality foods should be used.

1. Prepare the food as recommended.
2. Arrange the food on drying racks (not included with the oven; contact a local store handling speciality cooking utensils).
3. VGR models—Set the temperature control to 200°F (93.3°C) and turn on the convection fan switch.
VDR models - Set the temperature control to 200°F (93.3°C) and turn the selector to "TRU CONV".

Air is circulated by a motorized fan in the rear of the oven. The fan accelerates natural defrosting of the food without heat. To avoid sickness and food waste, **DO NOT** allow defrosted food to remain in the oven for more than two hours.

⚠ CAUTION

You must carefully check the food during the dehydration process to ensure that it does not catch fire.

Convection Defrost

1. Place the frozen food on a baking sheet.
2. VGR models—Set the oven temperature control knob to "OFF" and turn on the convection fan switch.
VDR models - Set the temperature control knob to "OFF" and turn the selector to "TRU CONV".

⚠ WARNING

To avoid sickness and food waste, **DO NOT** allow defrosted food to remain in the oven for more than two hours.

Cleaning and Maintenance

Any piece of equipment works better and lasts longer when maintained properly and kept clean. Cooking equipment is no exception. Your range must be kept clean and maintained properly. Before cleaning, make sure all controls are in the "OFF" position. Disconnect power if you are going to clean thoroughly with water.

Surface Burners

Wipe up spill-overs as soon as possible after they occur and before they get a chance to burn in and cook solid. In the event of a spill-over, follow these steps:

- Allow the burner and grate to cool to a safe temperature level.
- Lift off the burner grate. Wash in warm soapy water.
- Remove the burner head and burner base and clean.



Burner Heads

The surface burner heads should be routinely removed and cleaned.

ALWAYS clean the burner heads after a spill-over. Keeping the burner heads clean will prevent improper ignition and uneven flames. To clean, pull burner head straight up from the burner base. Wipe off with warm, soapy water and a soft cloth after each use. Use a non-abrasive cleanser such as Bon Ami™ and a soft brush or soft Scotch Brite™ pad for cooked-on foods. If ports on burner head are clogged, clean with a straight pin.

DO NOT enlarge or distort the ports. **DO NOT** use a toothpick to clean the ports. Dry thoroughly after cleaning.

For best cleaning and to avoid possible rusting, **DO NOT** clean in dishwasher or self-cleaning oven. When replacing the burner head, carefully align the locator key in the outer edge below the burner ports with the small notch in the top front edge of the burner base. This will align the burner port with the ignitor.

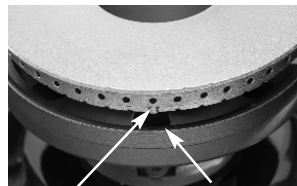

locator key burner base notch

Burner Base

To clean, pull burner base straight up from the burner flange. Wipe off with warm, soapy water and a soft cloth after each use. Use a non-abrasive cleanser such as Bon Ami™ and a soft brush or soft Scotch Brite™ pad for cooked-on foods. When replacing burner base, carefully align the three ribs underneath the burner base with the three grooves in the burner flange. Make sure the burner base is level by aligning the rib that has a pin with the groove that has a hole.

Cleaning and Maintenance

Note: For stubborn stains, use a non abrasive cleanser such as Bon Ami™ and a soft brush or soft Scotch Brite™ pad.

Cleaning Tip: For difficult to clean burner heads and bases, place parts in a zip seal bag with ammonia.

Burner Flange

After the burner flange has cooled, it should be wiped with hot soapy water but do not allow water to run or drip in the large center opening. **DO NOT** use steel wool, abrasive cloths, cleanser, or powders. To remove encrusted materials, soak the area with a hot towel to loosen the material, then use a wooden or nylon spatula.

DO NOT use a metal knife, spatula, or any other metal tool to scrape the burner flange.

- Wipe up any spills which remain on the sealed top surface.
- Replace burner base, burner head, and grates after drying thoroughly.



Control Panel

DO NOT use any cleaners containing ammonia or abrasives. They could remove the graphics from the control panel. Use hot, soapy water and a soft clean cloth.

Control Knobs

MAKE SURE ALL THE CONTROL KNOBS POINT TO THE OFF POSITION BEFORE REMOVING. Pull the knobs straight off. Wash in detergent and warm water. Dry completely and replace by pushing firmly onto stem. **DO NOT** use any cleaners containing ammonia or abrasives. They could remove the graphics from the knob.



Cleaning and Maintenance

Oven Surfaces

Several different finishes have been used in your oven.

NEVER USE AMMONIA, STEEL WOOL PADS OR ABRASIVE CLOTHS, CLEANSERS, OVEN CLEANERS, OR ABRASIVE POWDERS. THEY CAN PERMANENTLY DAMAGE YOUR OVEN.

VDR models – Your oven features a self-clean cycle for the oven interior. See the “Self-Clean Cycle” section for complete instructions.

Stainless Steel Parts

All stainless steel body parts should be wiped regularly with hot soapy water after they have cooled and with a liquid cleaner designed for that material when soapy water will not do the job. **DO NOT** use steel wool, abrasive cloths, cleansers, or powders. If necessary, scrape stainless steel to remove encrusted materials, soak the area with hot towels to loosen the material, then use a wooden or nylon spatula or scraper. **DO NOT** use a metal knife, spatula, or any other metal tool to scrape stainless steel. **DO NOT** permit citrus or tomato juice to remain on stainless steel surface, as citric acid will permanently discolor stainless steel. Wipe up any spills immediately.

Glass Surfaces

Clean with detergent and warm water. Glass cleaner can be used to remove fingerprints. If using glass cleaner ammonia, make sure that it does not run down on exterior door surface.

Broiler Pan and Grid

Clean with detergent and hot water. For stubborn spots, use a soap-filled steel wool pad.

Oven Racks

Clean with detergent and hot water. Stubborn spots can be scoured with a soap-filled steel wool pad.

Self-Clean Cycle

VDR Dual Fuel models only

This oven features an automatic pyrolytic self-cleaning cycle. During this cycle, the oven reaches elevated temperatures in order to burn-off soil and deposits. An integral smoke eliminator helps reduce odors associated with the soil burn-off. A powder ash residue is left in the bottom of the oven after completion of the self-clean cycle. The door latch is automatically activated after selecting the self-clean setting. The latch ensures that the door cannot be opened while the oven interior is at cleaning temperatures.

Before starting the Self-Clean cycle:

1. Remove the oven racks, and any other items/utensils from the oven. The high heat generated during the cleaning cycle can discolor, warp, and damage these items. **DO NOT** use foil or liners in the oven. During the self-clean cycle, foil can burn or melt and damage the oven surface.
2. Wipe off any large spills from the oven bottom and sides. **NEVER** use oven cleaners inside a self-cleaning oven or on raised portions of the door.
3. Some areas of the oven must be cleaned by hand before the cycle begins. Soils in these areas will be baked on and very difficult to clean if not removed first. Clean the door up to the gasket, the door frame, and up to 2 inches inside the frame with detergent and hot water. Rinse thoroughly and dry.

⚠ WARNING



BURN OR ELECTRICAL SHOCK HAZARD

Make sure all controls are OFF and oven is COOL before cleaning. Failure to do so can result in burns or electrical shock.

⚠ CAUTION

DO NOT touch the exterior portions of the oven after self-cleaning cycle has begun, since some parts become extremely hot to the touch! During the first few times the self-cleaning feature is used, there may be some odor and smoking from the curing of the binder in the high-density insulation used in the oven. When the insulation is thoroughly cured, this odor will disappear. During subsequent self-cleaning cycles, you may sense an odor characteristic of high temperatures. Keep the kitchen well-vented during the self-cleaning cycle.

Self-Clean Cycle (VDR Dual Fuel models)

To start the Self-Clean cycle:

1. Close the door completely.
2. Turn the oven selector knob clockwise to the "SELF CLEAN" mode.
3. Turn the temperature control knob to the clean setting stop. At this time, the clean indicator light will come on. Within 30 seconds the automatic door latch engages and the oven indicator light comes on. The oven indicator light will remain on until the oven reaches the self-clean temperature and will then cycle on and off during the self-clean cycle. When the oven reaches the elevated temperature needed for self-clean, the door lock indicator light comes on.
4. The door lock indicator light will remain on until the self-clean is completed or interrupted and the oven temperature drops to a safe temperature. A complete cycle is approximately 2-1/2 hours with an additional 30 minutes needed for the oven to cool down enough for the door latch to disengage.

Note: A fan noise will be heard during the self-clean cycle and will continue to run for the 2-1/2 hour duration of the self-clean cycle.

Note: On griddle model ranges, the griddle/simmer plate will not function during the self-clean cycle.

5. When the cycle is completed, turn both the oven selector and temperature control knob to the "OFF" position. When the oven has completely cooled, open door and remove any ash from the oven surfaces with a damp cloth.

To stop the Self-Clean cycle:

To cancel or interrupt the self-cleaning cycle, turn both the temperature control knob and the oven function selector knob to "OFF". When the oven temperature drops to a safe temperature, the automatic door latch will release and the oven door can be opened. When the oven has completely cooled, remove any ash from the oven surfaces with a damp sponge or cloth.

Replacing Oven Lights

⚠ WARNING



ELECTRICAL SHOCK HAZARD

Disconnect the electric power at the main fuse or circuit breaker before replacing bulb.

⚠ WARNING

DO NOT touch bulb with bare hands. Clean off any signs of oil from the bulb and handle with a soft cloth.

DO NOT touch bulb with bare hands. Clean off any signs of oil from the bulb and handle with a soft cloth.

1. Unsnap glass light cover using a screwdriver in the access groove.
2. Firmly grasp light bulb and pull out.
3. Replace with halogen bulb using volt and wattage requirements listed on glass cover.
4. Replace the light cover by snapping glass cover onto metal box.
5. Reconnect power at the main fuse or circuit breaker.

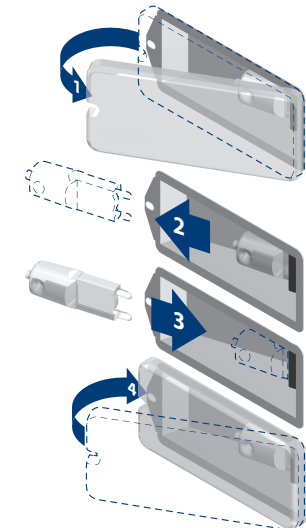

Door Removal

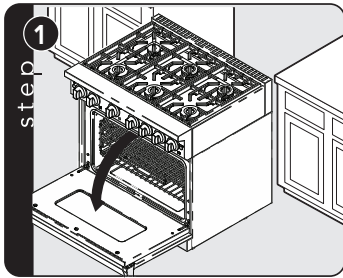

Open door completely.

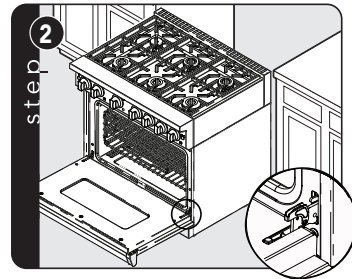

Fold latches backward until locked in place.

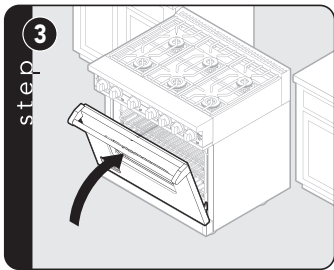

Slowly close until latches stop door.

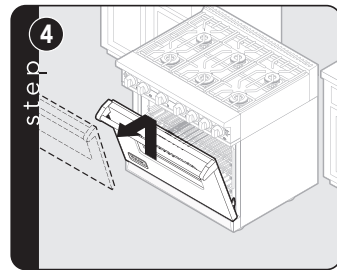

Lift door up and out.

Door Replacement

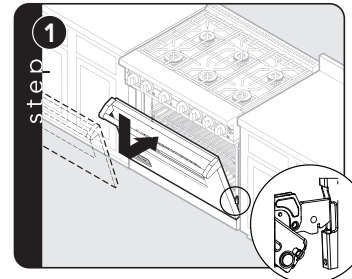

Carefully realign door on hinges.
Slide in and down.

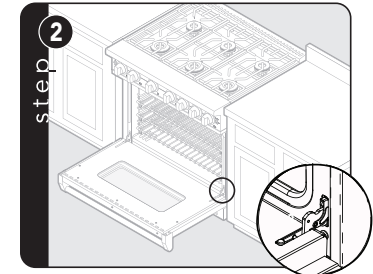

Open door completely.
Fold latches forward until locked in place.

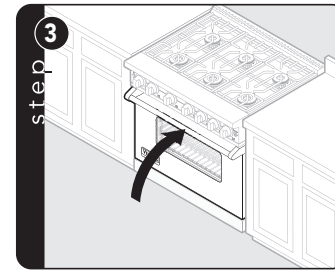

Close door.

Troubleshooting

Service Information

Problem	Possible Cause and/or Remedy
Range will not function.	Range is not connected to electrical power: Have electrician check power circuit breaker, wiring, and fuses.
Oven does not operate in self-clean.	Door is not shut tight enough for automatic door latch to lock.
Oven is not clean after self-clean cycle.	Temperature control knob not rotated all the way past clean until it stops.
Broil does not work.	Temperature control knob is rotated too far past broil position.
Door will not open.	Oven is still in self-clean mode. If oven is hot, door latch will release when safe temperature is reached.
Oven light will not work.	Light bulb is burned out. Range is not connected to power.
Igniters will not work.	Circuit is tripped. Fuse is blown. Range is not connected to power.
Igniters sparking but no flame ignition.	Gas supply valve is in "OFF" position. Gas supply is interrupted.
Igniters sparking continuously after flame ignition.	Power supply is not grounded. Power supply polarity is reversed. Igniters are wet or dirty.
Burner ignites but flame is large, distorted, or yellow.	Burner ports are clogged. Unit is being operated on wrong type of gas. Air shutters not properly adjusted.
Strong odor and/or smoke is noticed first few times oven is used.	This is normal burn off of insulation and protective oils in oven. This will go away after using oven a few times.
Oven indicator light on; oven will not heat	Oven is operating properly. Unit will resume heating function once it has cooled.

If service is required, call your dealer or authorized service agency. The name of the authorized service agency can be obtained from the dealer or distributor in your area.

Have the following information readily available.

- Model number
- Serial number
- Date purchased
- Name of dealer from whom purchased

Clearly describe the problem that you are having. If you are unable to obtain the name of an authorized service agency, or if you continue to have service problems, contact Viking Range, LLC at 1-888-845-4641, or write to:

**VIKING RANGE, LLC
PREFERRED SERVICE
111 Front Street
Greenwood, Mississippi 38930 USA**

Record the information indicated below. You will need it if service is ever required. The model and serial number for your range can be found by opening door and looking under the control panel. .

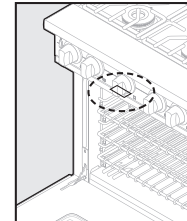

Model no. _____ Serial no. _____

Date of purchase _____ Date installed _____

Dealer's name _____

Address _____

If service requires installation of parts, use only authorized parts to insure protection under the warranty.

Keep this manual for future reference.

Warranty

PROFESSIONAL SERIES FREESTANDING GAS/DUAL FUEL RANGES WARRANTY

THREE YEAR FULL WARRANTY

Freestanding gas ranges and all of their component parts, **except as detailed below†**, are warranted to be free from defective materials or workmanship in normal residential use for a period of three (3) years from the date of original retail purchase or closing date for new construction, whichever period is longer. Viking Range, LLC, warrantor, agrees to repair or replace, at its option, any part which fails or is found to be defective during the warranty period.

***FULL NINETY (90) DAY COSMETIC WARRANTY:** Product is warranted to be free from cosmetic defects in materials or workmanship (such as scratches on stainless steel, paint/porcelain blemishes, etc.) for a period of ninety (90) days from the date of original retail purchase or closing date for new construction, whichever period is longer. Any defects must be reported to the selling dealer within ninety (90) days from date of original retail purchase. Viking Range, LLC uses high quality processes and materials available to produce all color finishes. However, slight color variation may be noticed because of the inherent differences in painted parts and porcelain parts as well as differences in kitchen lighting, product locations, and other factors. Therefore, this warranty does not apply to color variation attributable to such factors.

†FULL NINETY (90) DAY WARRANTY IN "RESIDENTIAL PLUS" APPLICATIONS: This full warranty applies to applications where use of the product extends beyond normal residential use, but the warranty period for products used in such applications is ninety (90) days. Examples of applications covered by this warranty are bed and breakfasts, fire stations, private clubs, churches, yachts, etc. Under this "Residential Plus" warranty, the product, its components and accessories are warranted to be free from defective material or workmanship for a period of ninety (90) days from the date of original retail purchase. This warranty excludes use of the product in all commercial locations such as restaurants, food service locations and institutional food service locations.

FIVE YEAR LIMITED WARRANTY ON BURNERS

Any surface burner, oven burner or element which fails due to defective materials or workmanship (excluding cosmetic failures) in normal household use during the fourth through fifth year from the date of original retail purchase will be repaired or replaced, free of charge for the part itself, with the owner paying all other costs, including labor. This does not include ignition systems, burner bases, etc.

TEN YEAR LIMITED WARRANTY ON PORCELAIN

Any porcelain oven or porcelain inner door panel which rusts through due to defective materials or workmanship in normal household use during the fourth through the tenth year from the date of original retail purchase will be repaired or replaced, free of charge for the part itself, with the owner paying all other costs, including labor.

LIMITED LIFETIME WARRANTY

During the life of the product, any stainless steel parts found to be defective in material or workmanship will be repaired or replaced, free of charge for the part itself, with the owner paying all other costs, including labor. This warranty excludes surface corrosion or rust, scratches, discoloration, water or atmospheric conditions, or cleaning practices which are part of normal residential use.

TERMS AND CONDITIONS

This warranty extends to the original purchaser of the product warranted hereunder and to each transferee owner of the product during the term of the warranty and applies to products purchased and located in the United States, Canada, Mexico, and the Caribbean (excluding Cuba, Dominican Republic, and Haiti). Products must be purchased in the country where service is requested. If the product or one of its component parts contains a defect or malfunction during the full warranty period after a reasonable number of attempts by the warrantor to remedy the defect or malfunction, the owner is entitled to either a refund or replacement of the product or its component part or parts. Replacement of a component part includes its free installation, except as specified under the limited warranty. Under the terms of this warranty, service must be performed by a factory authorized Viking Range, LLC service agent or representative. Service will be provided during normal business hours, and labor performed at overtime or premium rates shall not be covered by this warranty. Owner shall be responsible for proper installation, providing reasonable and necessary maintenance, providing proof of purchase upon request, and making the appliance reasonably accessible for service. The return of the Owner Registration Card is not a condition of warranty coverage. You should, however, return the Owner Registration Card so that Viking Range, LLC can contact you should any question of safety arise which could affect you.

This warranty gives you specific legal rights, and you may also have other rights which may vary from jurisdiction to jurisdiction.

Warranty (cont.)

WHAT IS NOT COVERED BY THIS WARRANTY: This warranty shall not apply to damage resulting from abuse, failure to provide reasonable and necessary maintenance, accident, delivery, negligence, natural disaster, loss of electrical power to the product for any reason, alteration, outdoor use, improper installation, improper operation, or repair or service of the product by anyone other than an authorized Viking Range, LLC service agency or representative. This warranty does not apply to commercial usage.

LIMITATION OF REMEDIES AND DURATION OF IMPLIED WARRANTY OWNER'S SOLE AND EXCLUSIVE REMEDY FOR A CLAIM OF ANY KIND WITH RESPECT TO THIS PRODUCT SHALL BE THE REMEDIES SET FORTH ABOVE. VIKING RANGE, LLC IS NOT RESPONSIBLE FOR CONSEQUENTIAL OR INCIDENTAL DAMAGE, INCLUDING BUT NOT LIMITED TO FOOD OR MEDICINE LOSS, DUE TO PRODUCT FAILURE, WHETHER ARISING OUT OF BREACH OF WARRANTY, BREACH OF CONTRACT OR OTHERWISE. Some jurisdictions do not allow the exclusion or limitation of incidental or consequential damages, so the above limitation or exclusions may not apply to you. **ANY IMPLIED WARRANTIES OF MERCHANTABILITY OR FITNESS FOR A PARTICULAR PURPOSE APPLICABLE TO THIS PRODUCT ARE LIMITED IN DURATION TO THE PERIOD OF COVERAGE OF THE APPLICABLE EXPRESS WRITTEN LIMITED WARRANTIES SET FORTH ABOVE.** Some states do not allow limitations on how long an implied warranty lasts, so the above limitation may not apply to you.

WARRANTY SERVICE

To obtain warranty service, contact an authorized Viking Range, LLC service agent, or Viking Range, LLC, 111 Front Street, Greenwood, Mississippi 38930, (888) 845-4641. Provide model and serial number and date of original purchase or closing date for a new construction. For the name of your nearest authorized Viking Range, LLC service agency, call Viking Range, LLC.

IMPORTANT: Retain proof of original purchase to establish warranty period.

Specifications subject to change without notice.

