

ASSEMBLY INSTRUCTIONS

Amelia 6LT Chandelier (Item#MT150-0079 MT150-0080)

Caution:

- **FOR YOUR SAFETY:** Turn off the power to main electric circuit/ fuse box before beginning work.

Important Safety Instructions:

- **Professional installation is recommended for hardwired lighting. Incorrect installation can lead to fires.**
- These instructions are provided for your safety. It is very important that they are read carefully and completely before assembling fixture.
- We strongly recommend that two people install the lighting fixture.
- This fixture has been rated for up to (6) **40-watt maximum TYPE B bulbs** (not included) or (6) **9-watt compact fluorescent light bulbs** (not included). To avoid the risk of fire, do not exceed the recommended wattage.
- This lighting fixture is intended for indoor, residential use.

Warning:

- **To reduce the risk of fire, electrical shock or personal injury, do not turn on lighting fixture until light bulb is installed and assembly is complete.**
- **Always turn off the lighting fixture and allow it to cool before replacing the light bulb.**





Care instructions:

- Do not polish or use harsh cleaners as they may damage the finish.
- Wipe clean with a non-colored, lint-free soft, dry cloth.



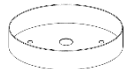



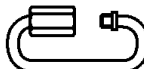



Pre-assembly:

- Remove all parts and hardware from box along with any plastic protective packaging.
- Check that all parts listed are included.
- Do not discard any contents until after assembly is complete to avoid accidentally discarding small parts or hardware.

Component List

Part code	Component	Description	Qty
A		Ceiling cap	1
B		Crossbar	1
C		Hang chain	1
D		Bulb	Not included
E		Quick link chain connector	1

Hardware List

Part code	Component	Description	Qty
F		Mounting screw	2
G		Plastic wire nut connector	3
H		Ground screw	1
I		Hex nut	2
J		Long screw	2
K		Cylinder nut	2
L		Finial	6
M		Fabric shade	6
N		Pipe	4
O		Tube	4
P		Chain loop	1

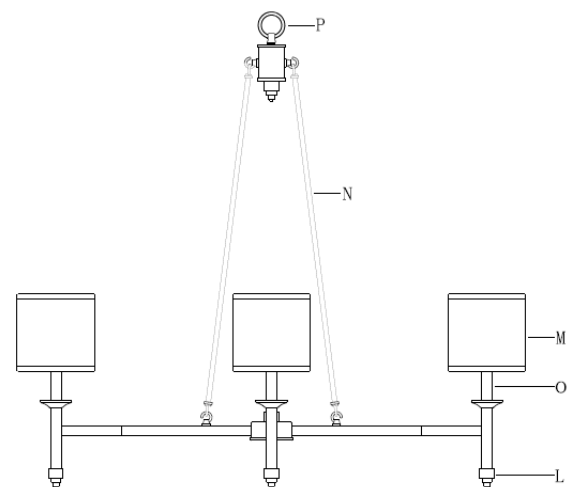
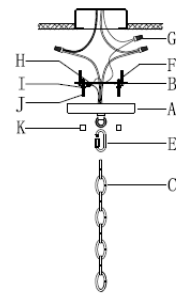

To Adjust the Suspension Length of the Fixture:

- The adjustment or shortening of the lighting fixture's suspension length is only needed if the factory set length is not appropriate for your installation. We recommend that you adjust the lighting fixture to the proper desired length before cutting the electrical cord.
- Determine the lighting fixture suspension length from the ceiling for the product installation, allowing the extra cord length for the outlet junction box wire connections. If needed, cut off the extra power cord length on the 3 wire cords so that they all at least 6 inches (152.4mm) long within the outlet junction box.

Assembly Instructions:

Step 1: Slide the canopy cap (A) and quick link chain connector(E), onto the hang chain (C).

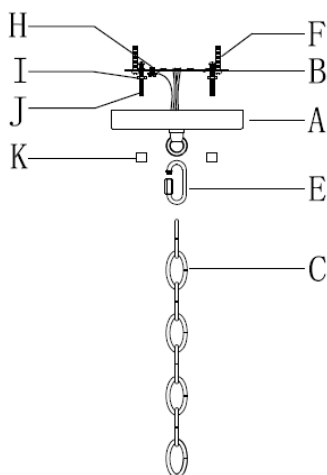

Step 2: With the help of another person to hold the weight of lighting fixture, attach the crossbar (B) onto the electrical junction box by using 2 mounting screws (F) with a screwdriver, then make the wire connection. Adjust the chain onto the ceiling cap(A), thread the screws(J) and the hex nuts(I) onto the round mounting plate(B) as shown. Ceiling cap(A) with hang chain(C) by quick link chain connector(E).

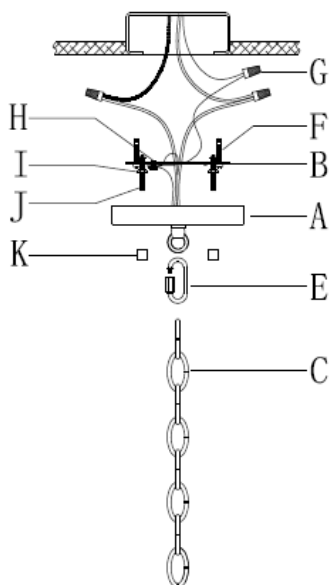

Step 3: Place the ceiling cap (A) and Cylinder nut (K) onto the ceiling. Make sure hold the ceiling cap (A) in place with

the Cylinder nut (K).

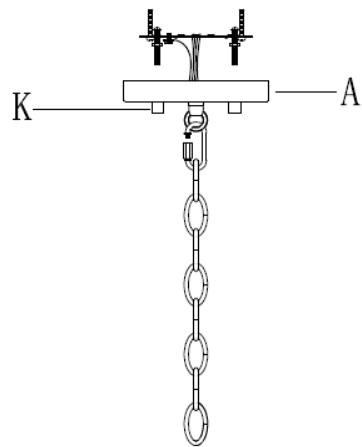

Step 4: Pass the wire through the chain loop. Attach chain loop(P) to fixture and secure tightly, then pipe(N) both end to fixture loop. Attach the fabric shade(M) and tube(O) onto the fixture socket, attach the finial(L) to the fixture.

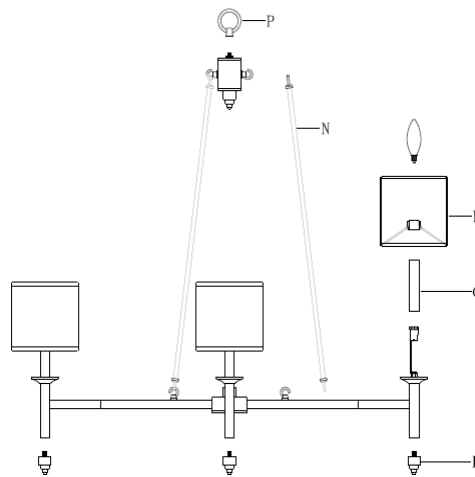

Step 5: Connect light body with hang chain (C) and install the bulbs (D)(not included).

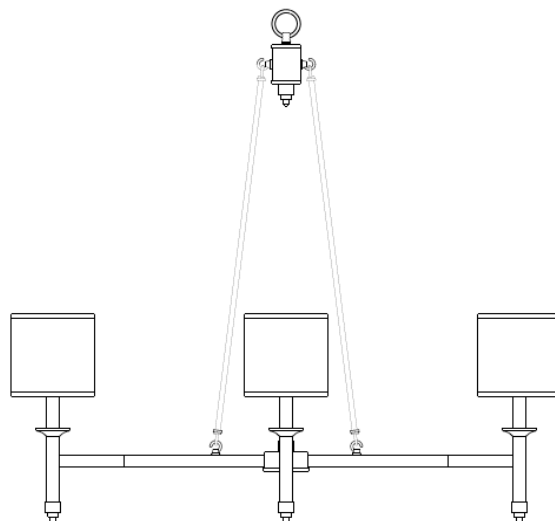

Thank you for your purchase