



Friends

42685



LEGO® Builder



LEGO.com/sustainable-packaging



FR
DONNEZ
OU
RECYCLEZ



OU



OU



ASSOCIATION MAGASIN DÉCHÈTERIE

Adresses sur quefairedemesdechets.fr



BUILDER



Apple and the Apple logo are trademarks of Apple Inc., registered in the U.S. and other countries and regions. App Store is a service mark of Apple Inc. Google Play and the Google Play logo are trademarks of Google LLC. Tencent and the Tencent logo are trademarks of Tencent Inc.



EN Ask parents' permission before going online | **DE** Eltern um Erlaubnis bitten, bevor du online gehst | **FR** Demande l'autorisation d'un parent avant d'aller en ligne | **IT** Chiedi il permesso ai tuoi genitori prima di andare online | **ES** Pídeles permiso a tus papás antes de conectarte a Internet | **PT** Peça autorização aos pais antes de acederes online | **ZH** 上网前应先征得父母的同意 | **PL** Poproś rodziców o zgodę, zanim wejdziesz do Internetu | **CS** Než půjdeš na internet, požádej rodiče o svolení | **SK** Skôr než pôjdeš na internet, vypýtaj si povolenie od rodičov | **HU** Kérj szülői engedélyt, mielőtt online csatlakoznál! | **UA** Запитуйте дозволу батьків, перш ніж користуватися інтернетом | **RO** Cere permisiunea părinților înainte de a te conecta online | **BG** Поискайте разрешение от родител, преди да влезете онлайн | **LV** Pirms došanās tiešsaistē palūdz atļauju vecākiem | **ET** Enne Interneti kasutamist küsi vanematelt luba | **LT** Prieš prisijungdami prie interneto, atsiklauskite tėvų



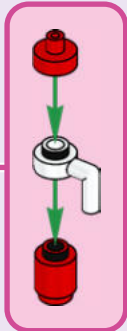
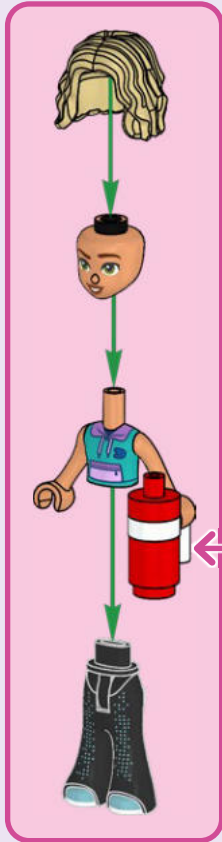

Nova



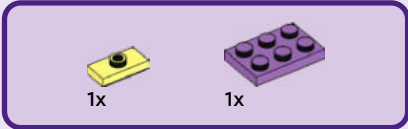

1

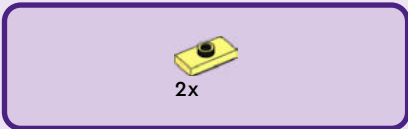
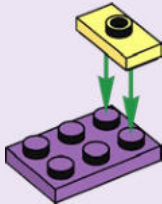

2

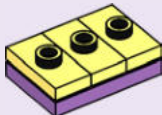

3x

3

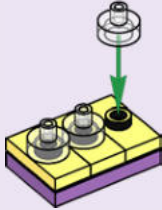

1x

4

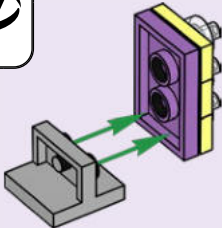

1x

5

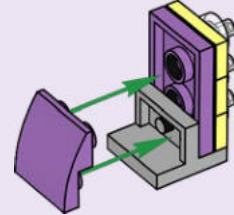

1x

1x

1x

6



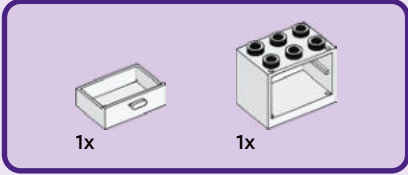

1

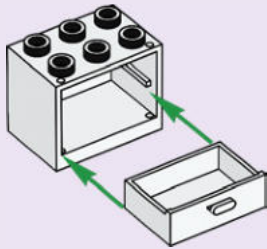

2

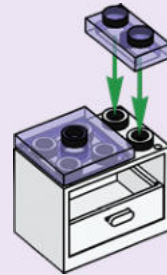

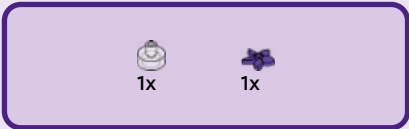

3

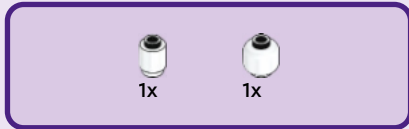

4

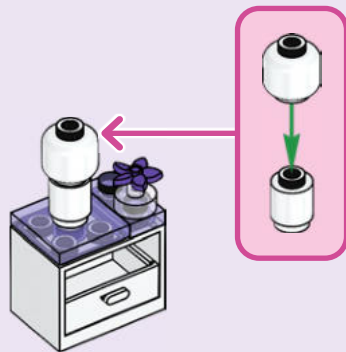

5



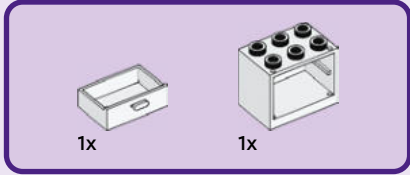

1

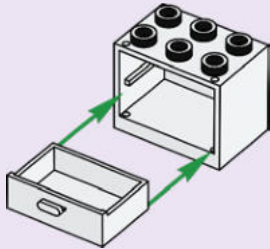

2



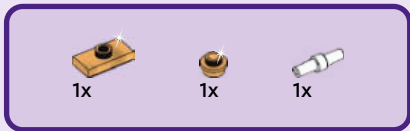

3

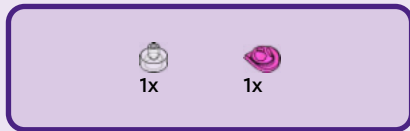
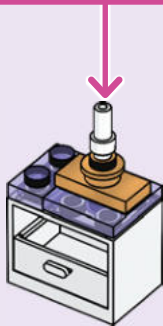
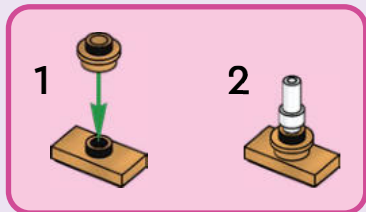

4

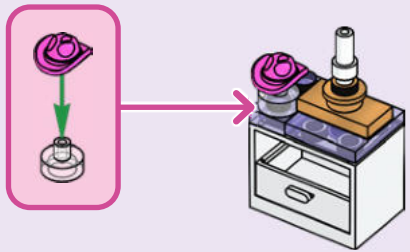

5









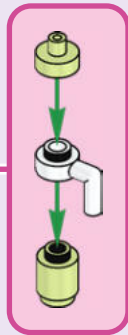
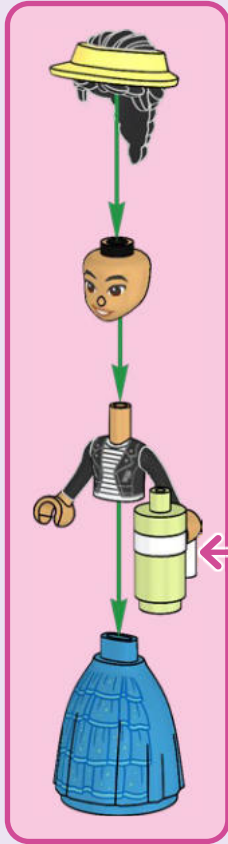

Liann







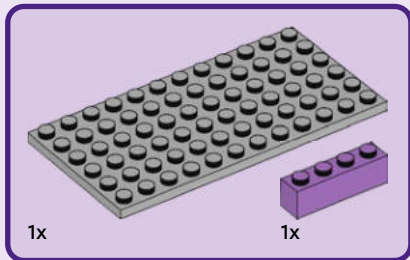

1

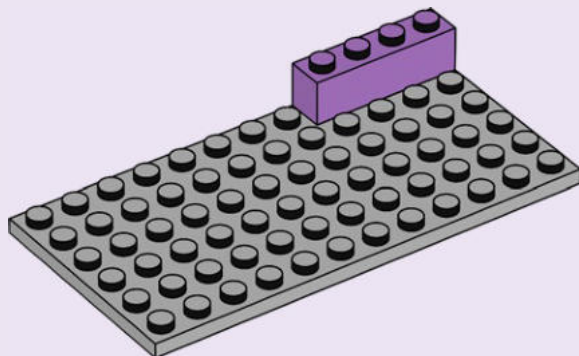

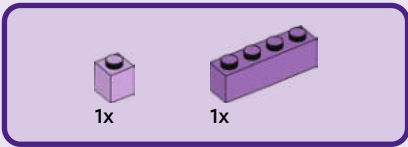

2

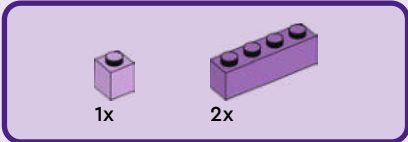
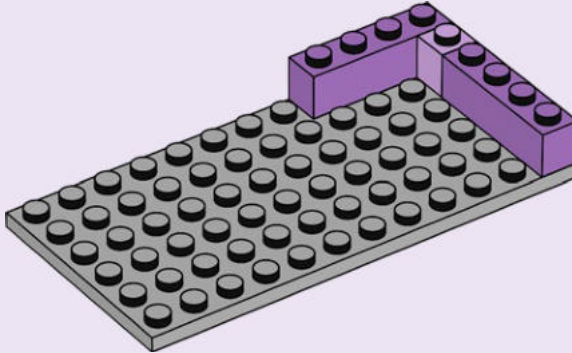

3

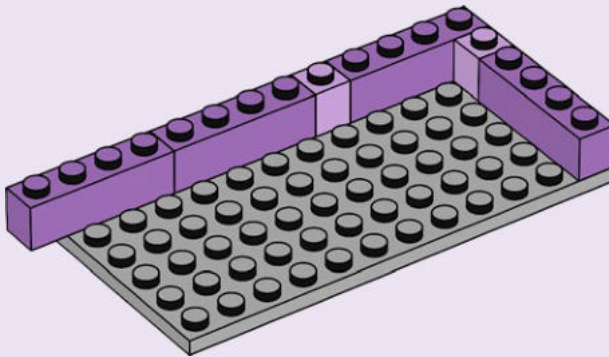

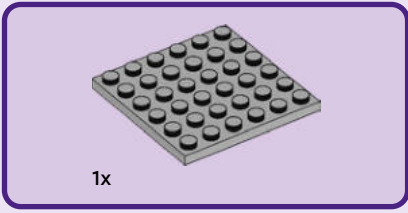

4

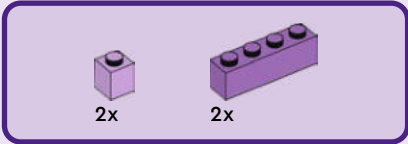
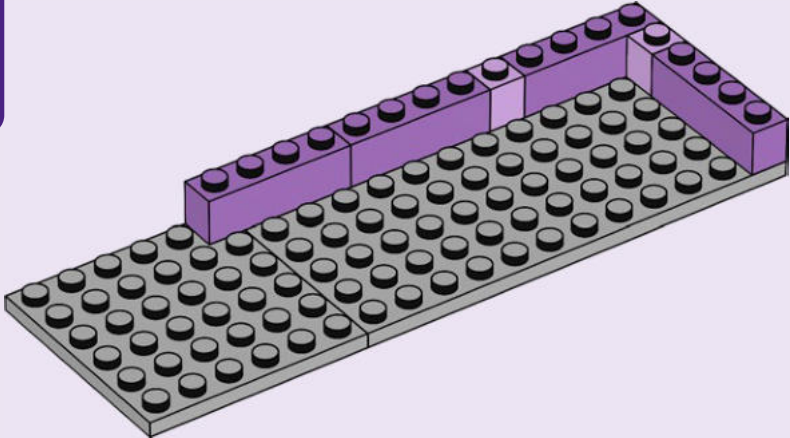

5

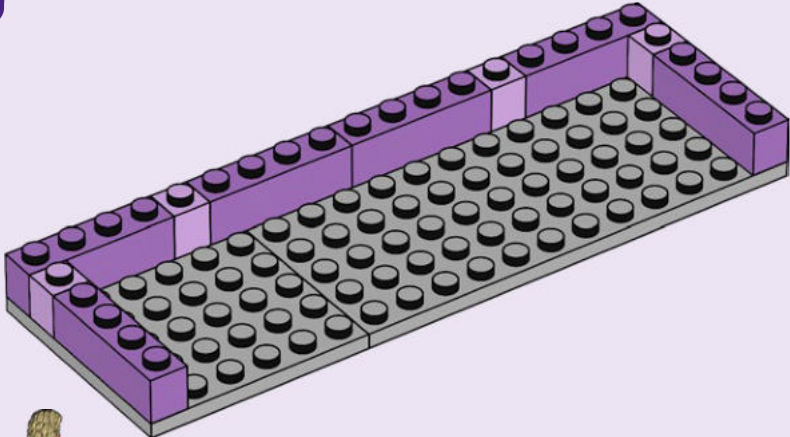

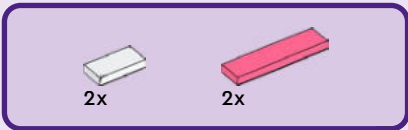

6

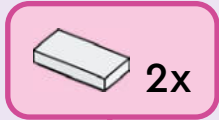
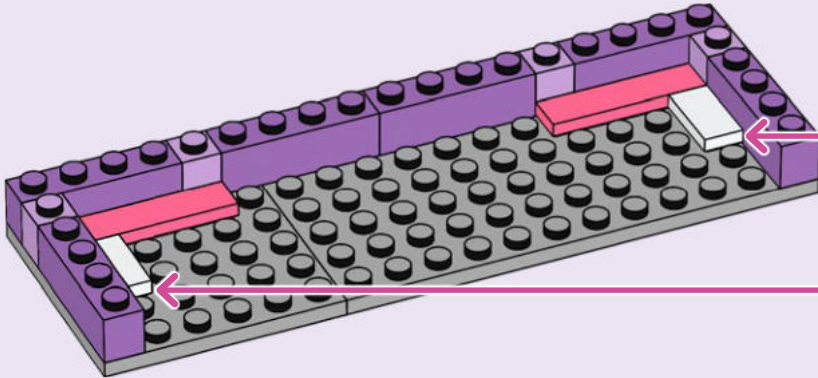

7

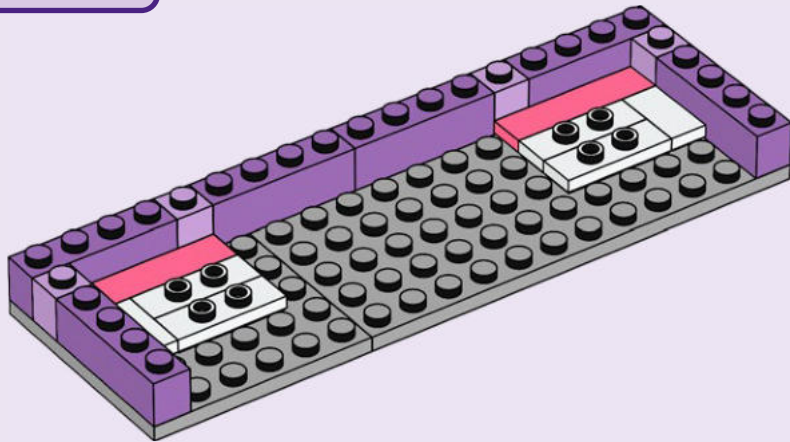

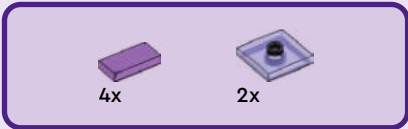

8

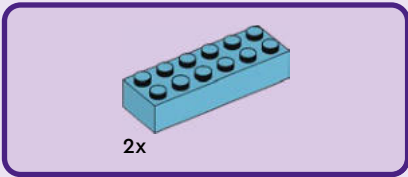
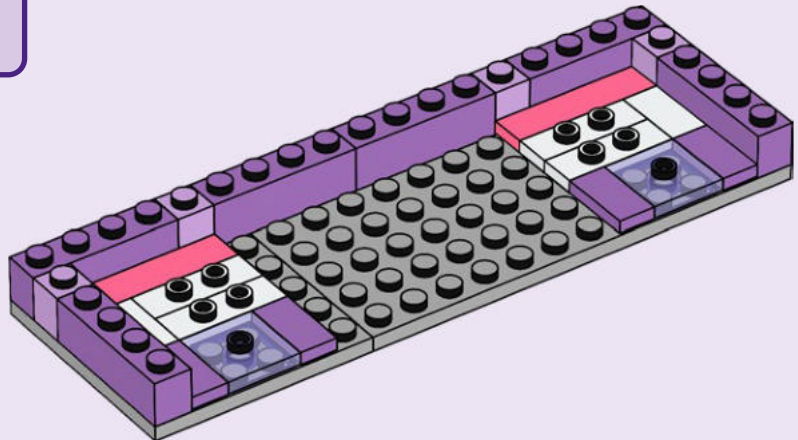

9

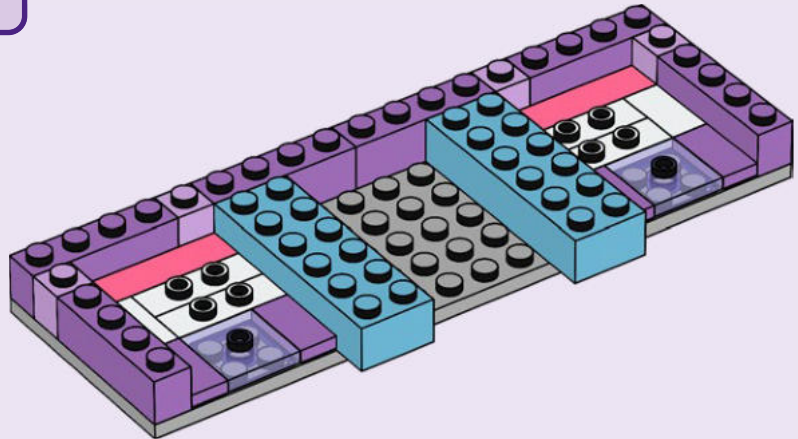

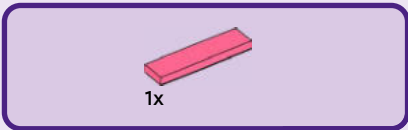

10

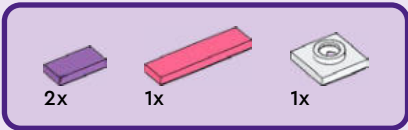
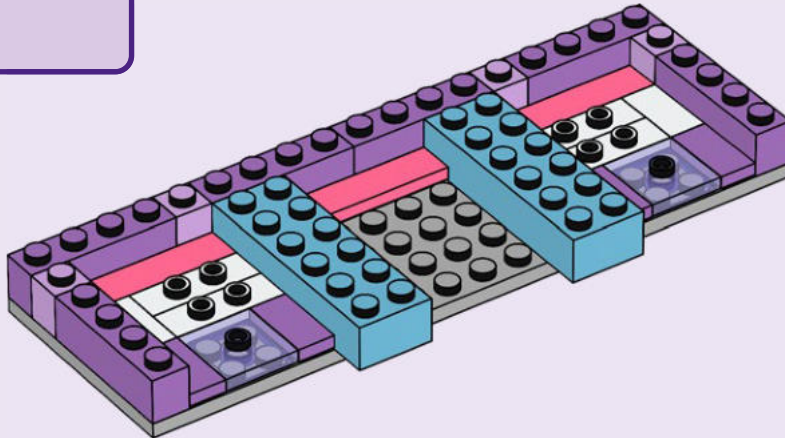

11

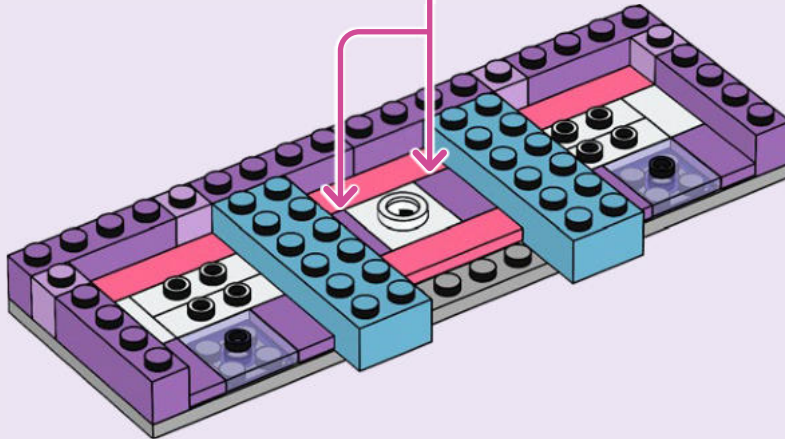



12

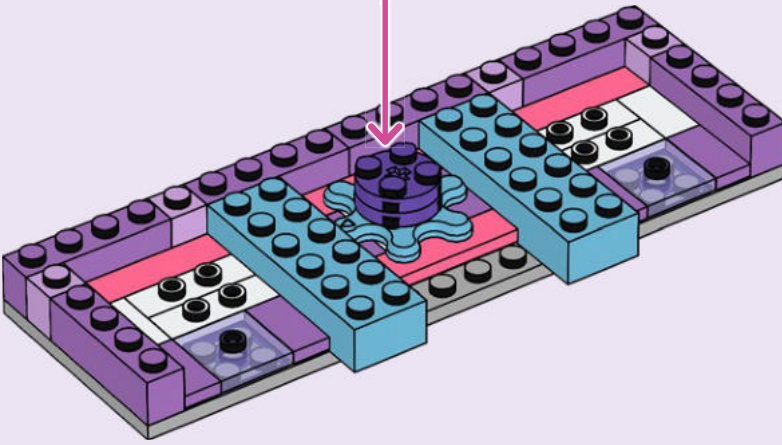
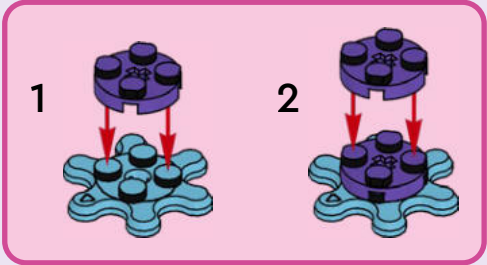

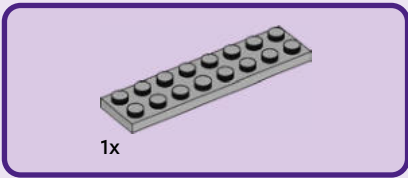

13

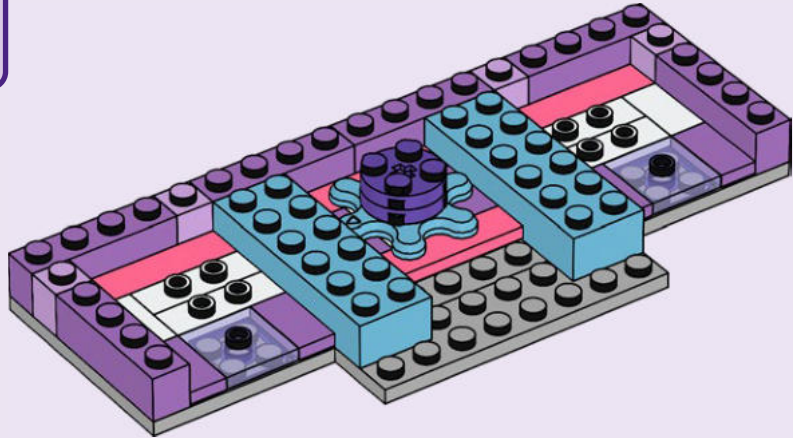

14

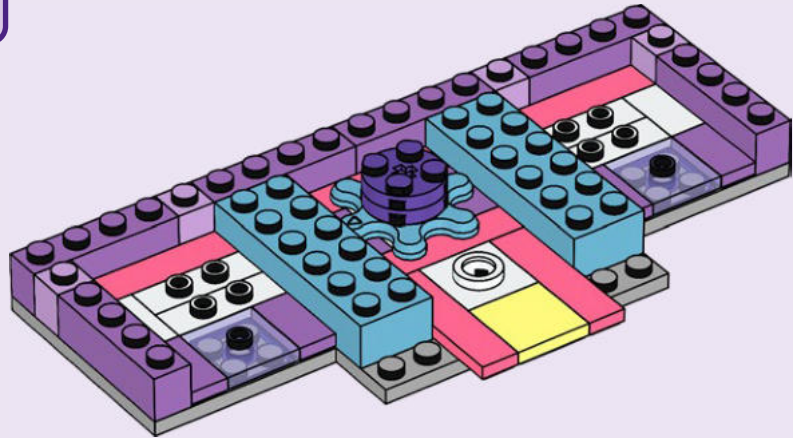



15

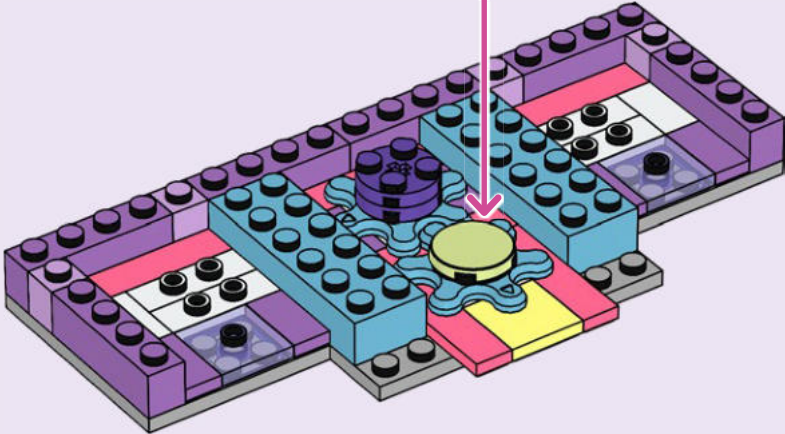
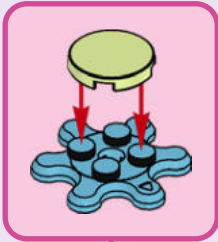

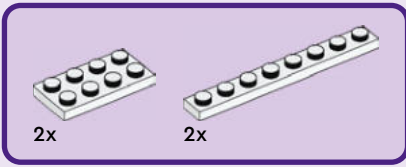

16

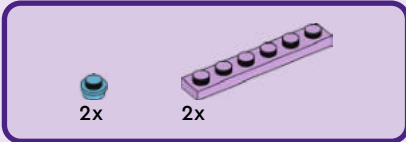
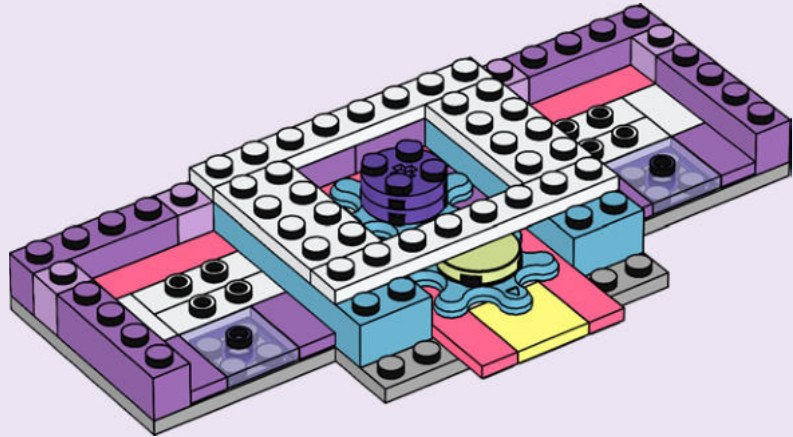

17

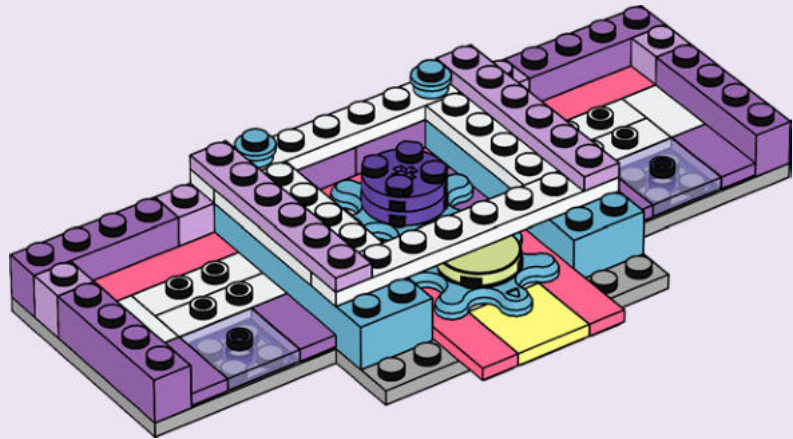



4x

18

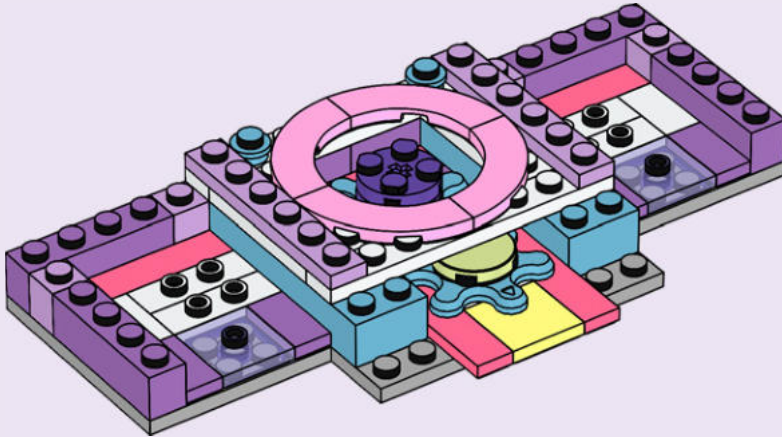



2x

19

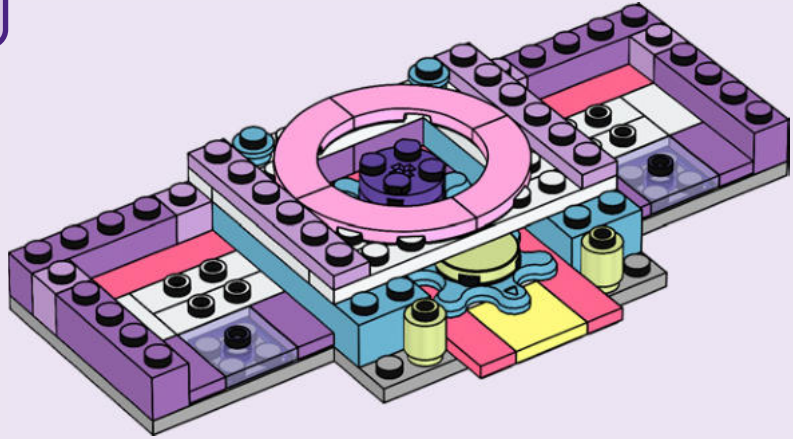

1x

20

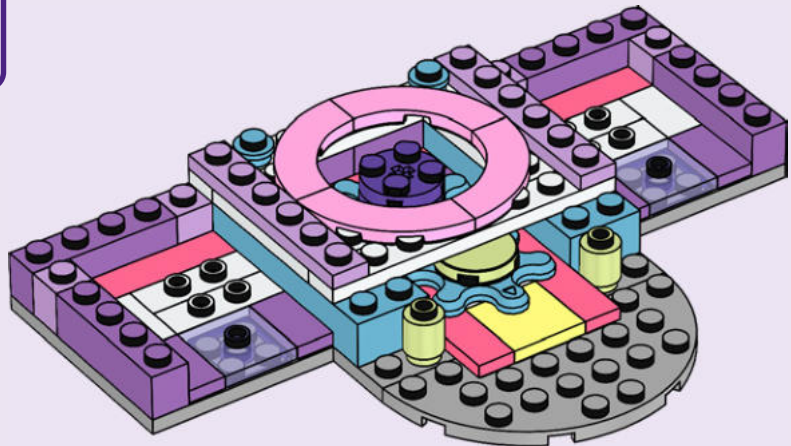



2x

21

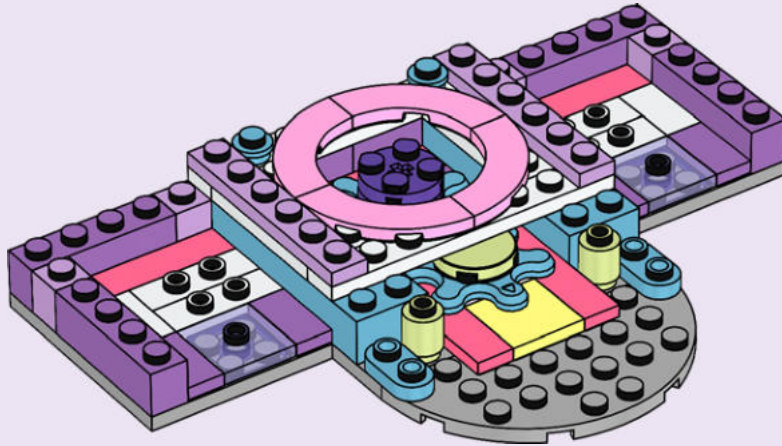



2x



2x

22

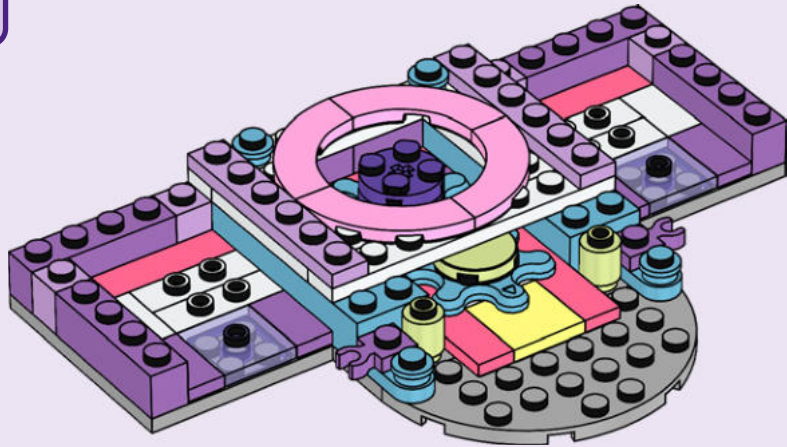

2x

23

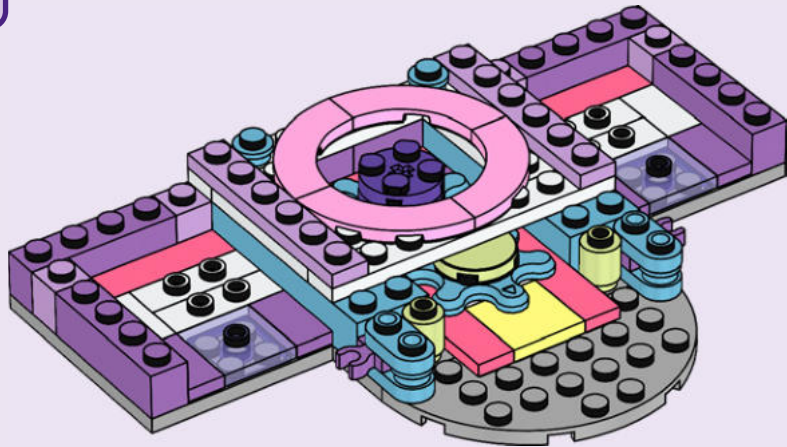



4x



1x

24

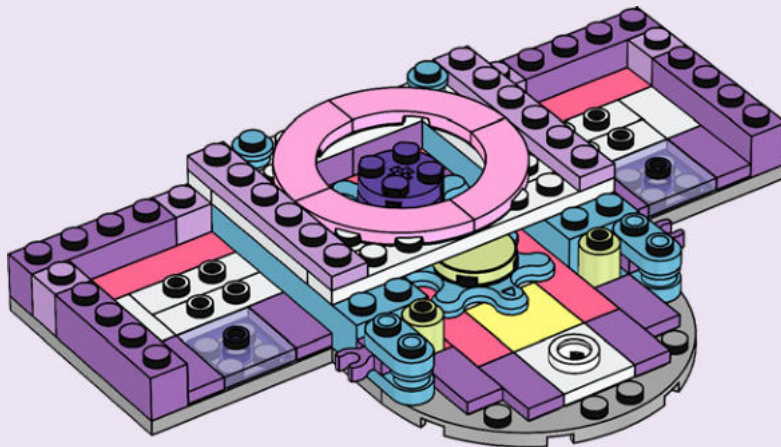



4x

25

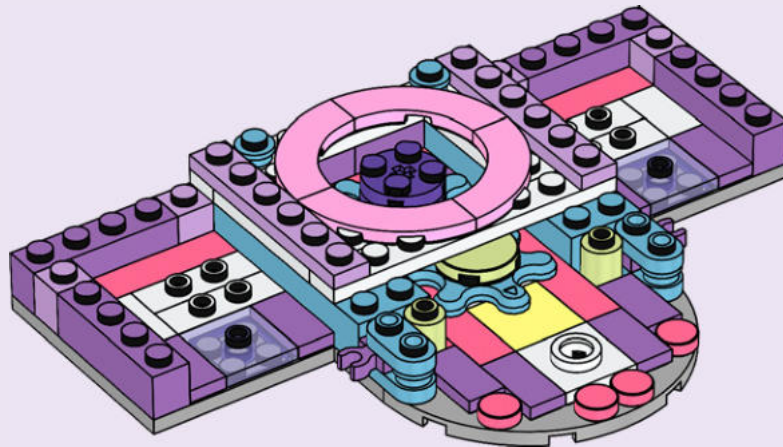

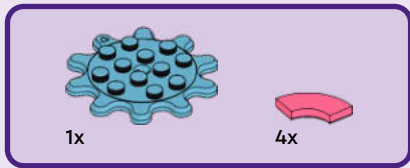

26

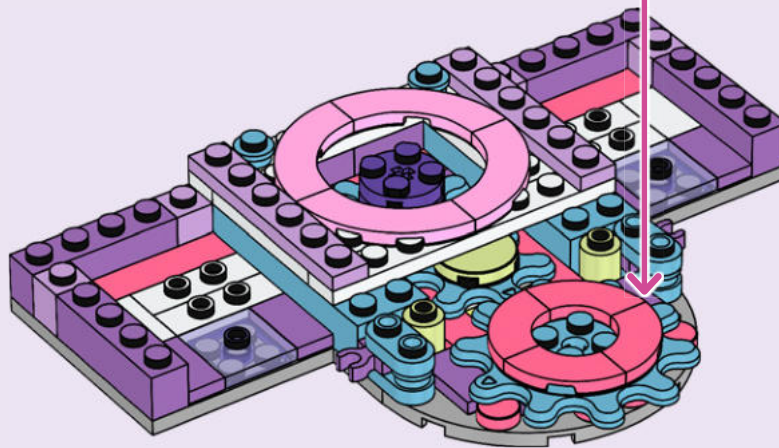
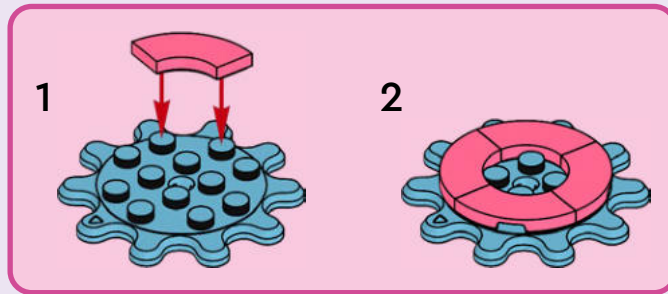



1x

27

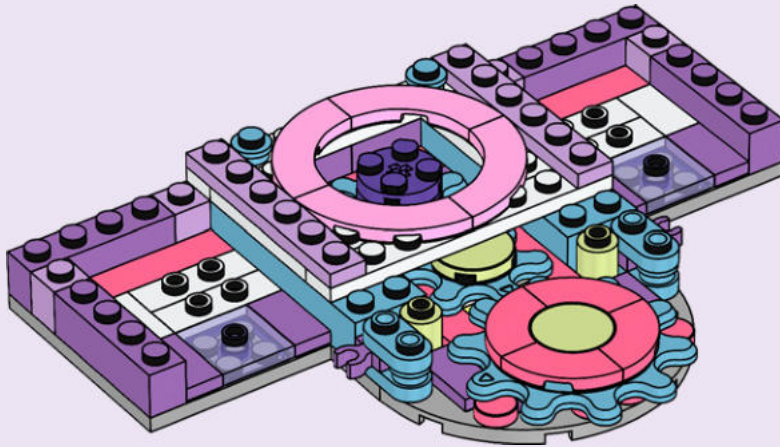

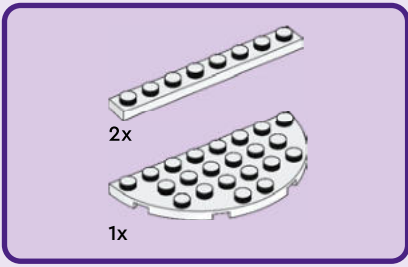

28

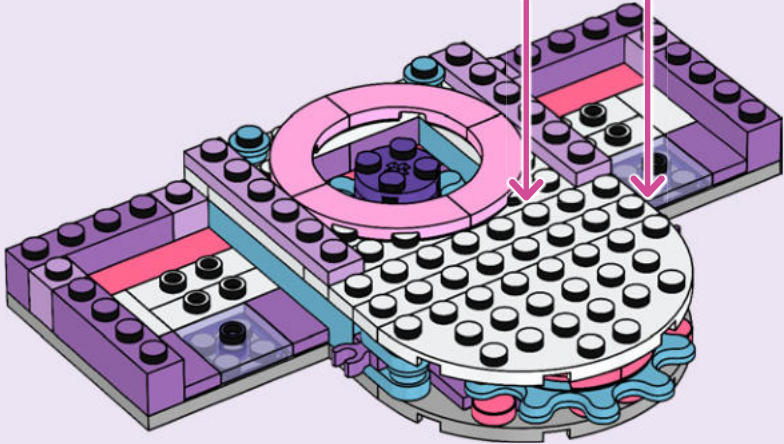
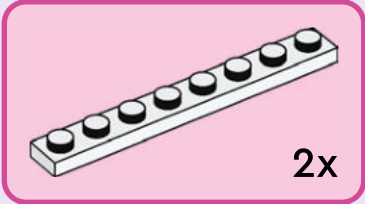



2x



6x

29

1



2

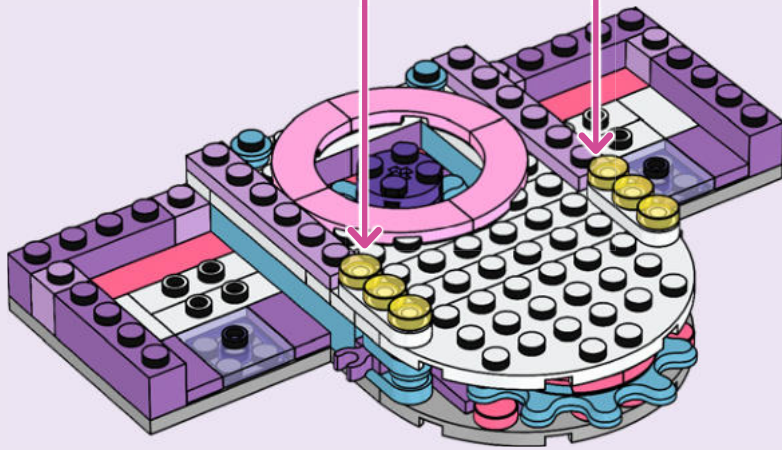

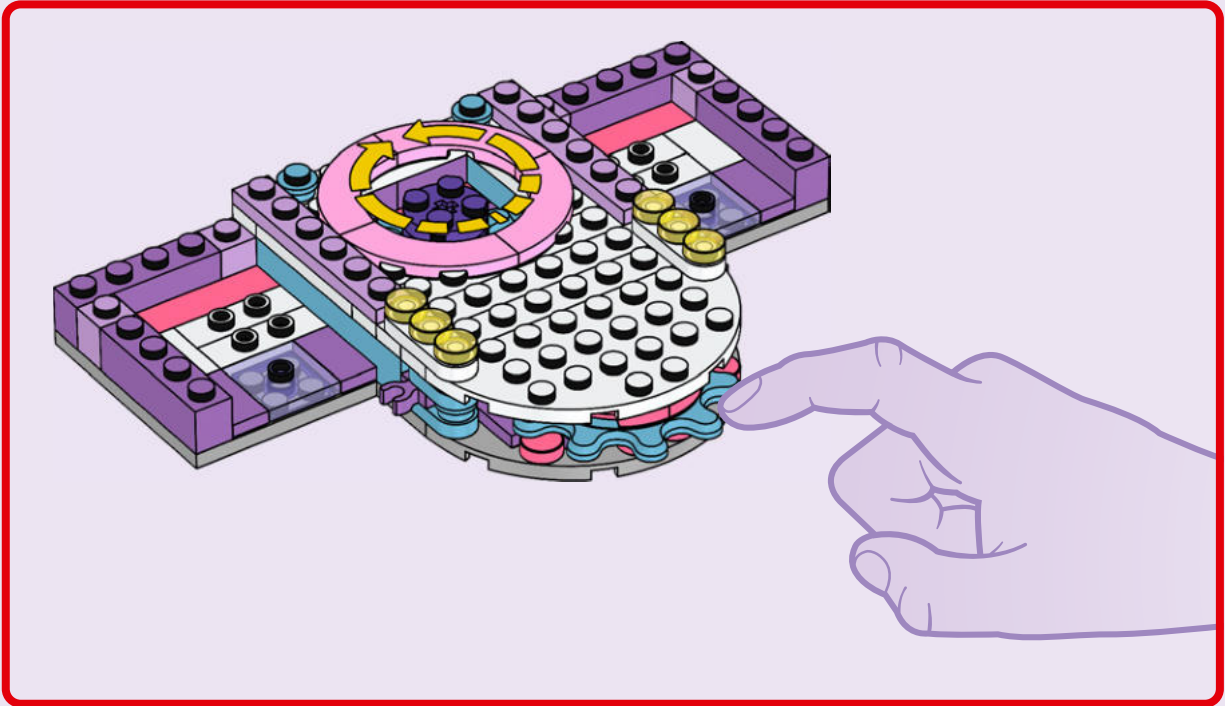



30

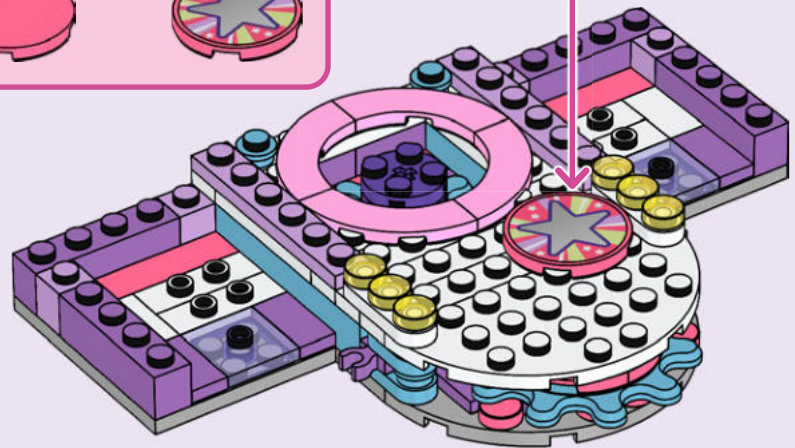

31

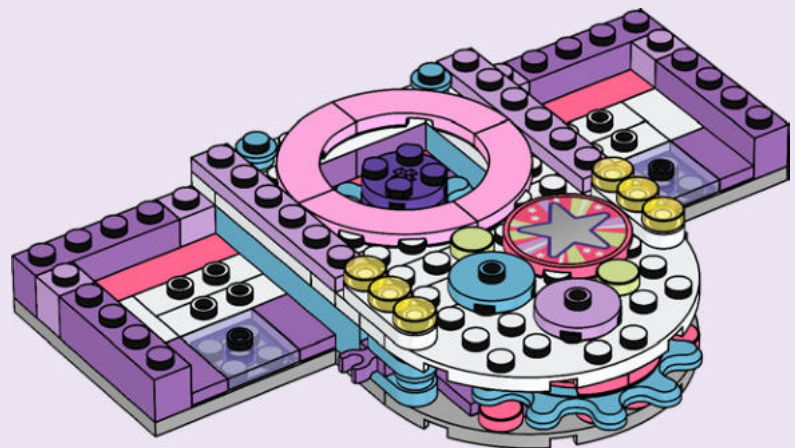

32

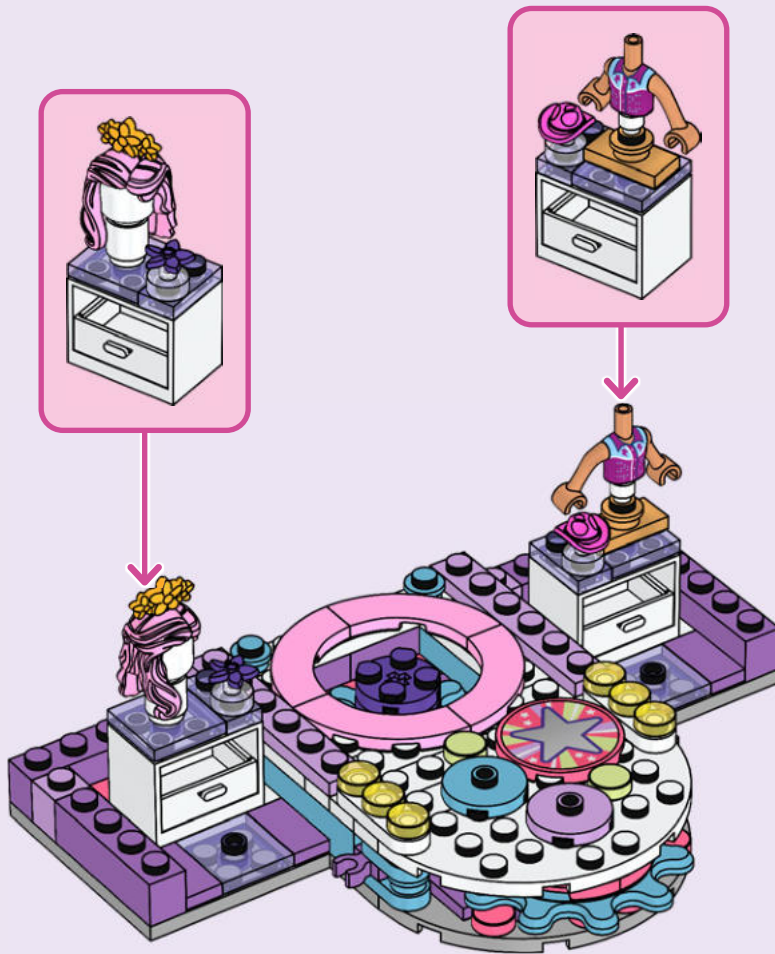

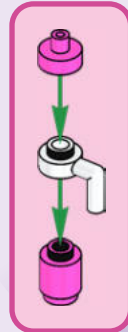
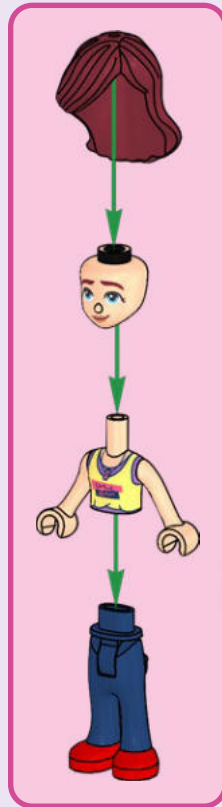

Paisley



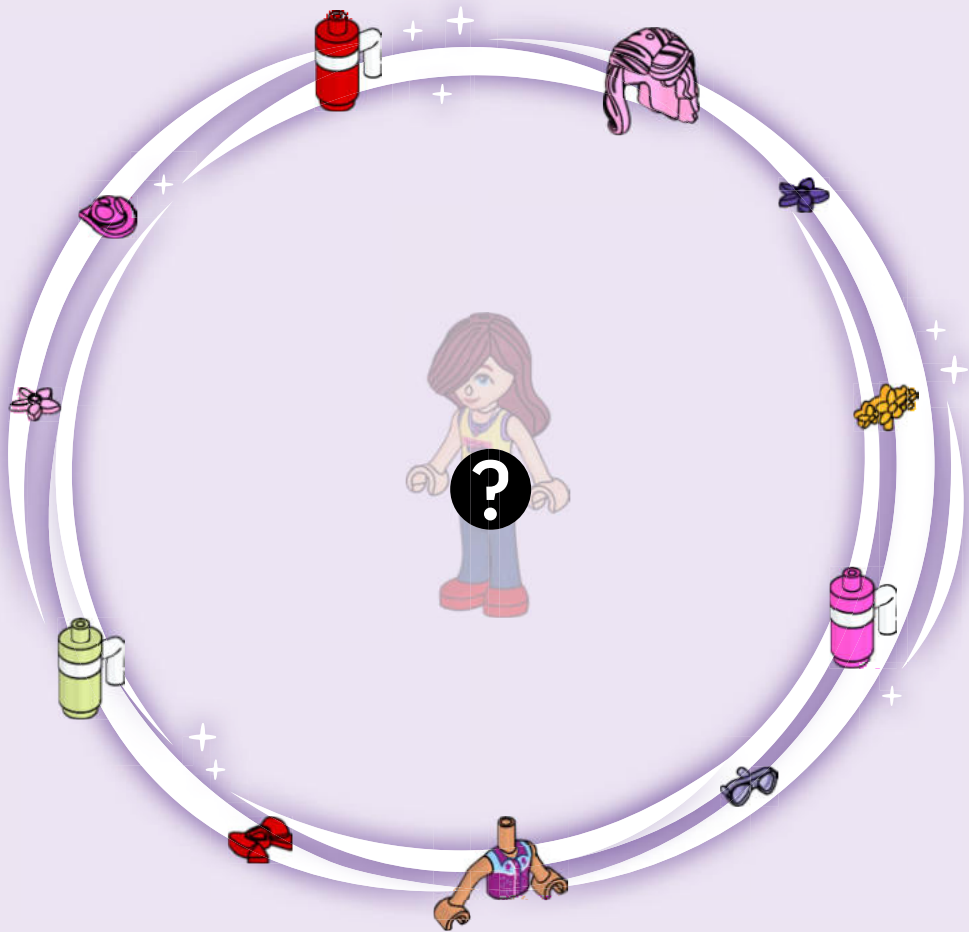



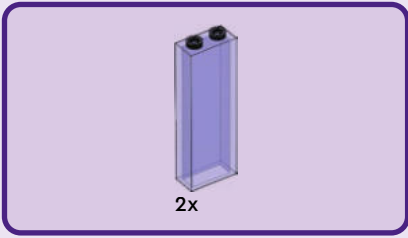

33

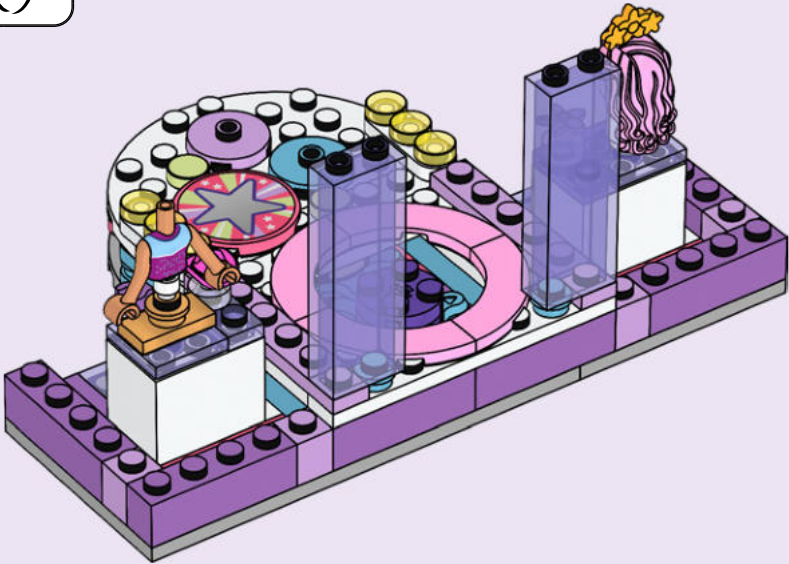

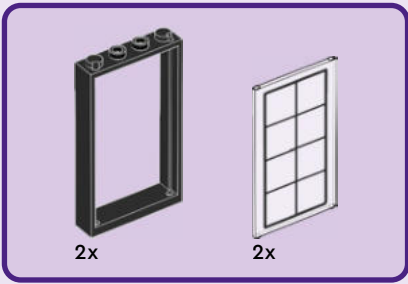

34

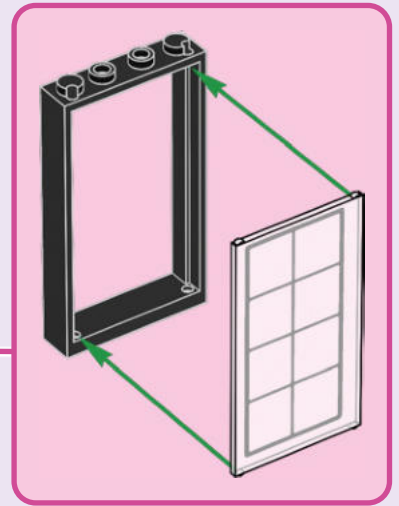
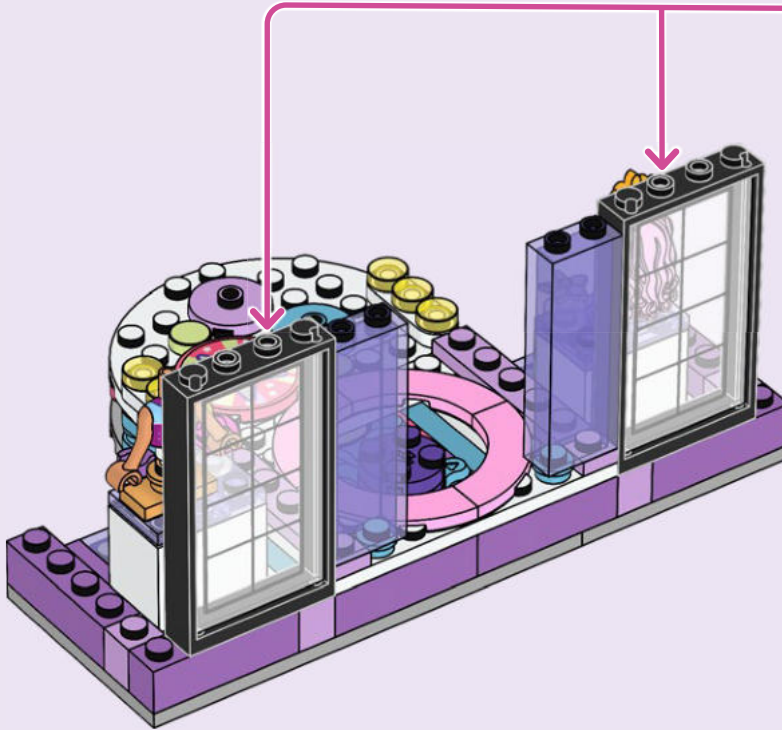

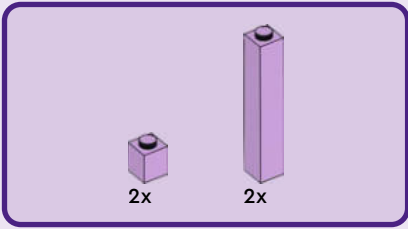

35

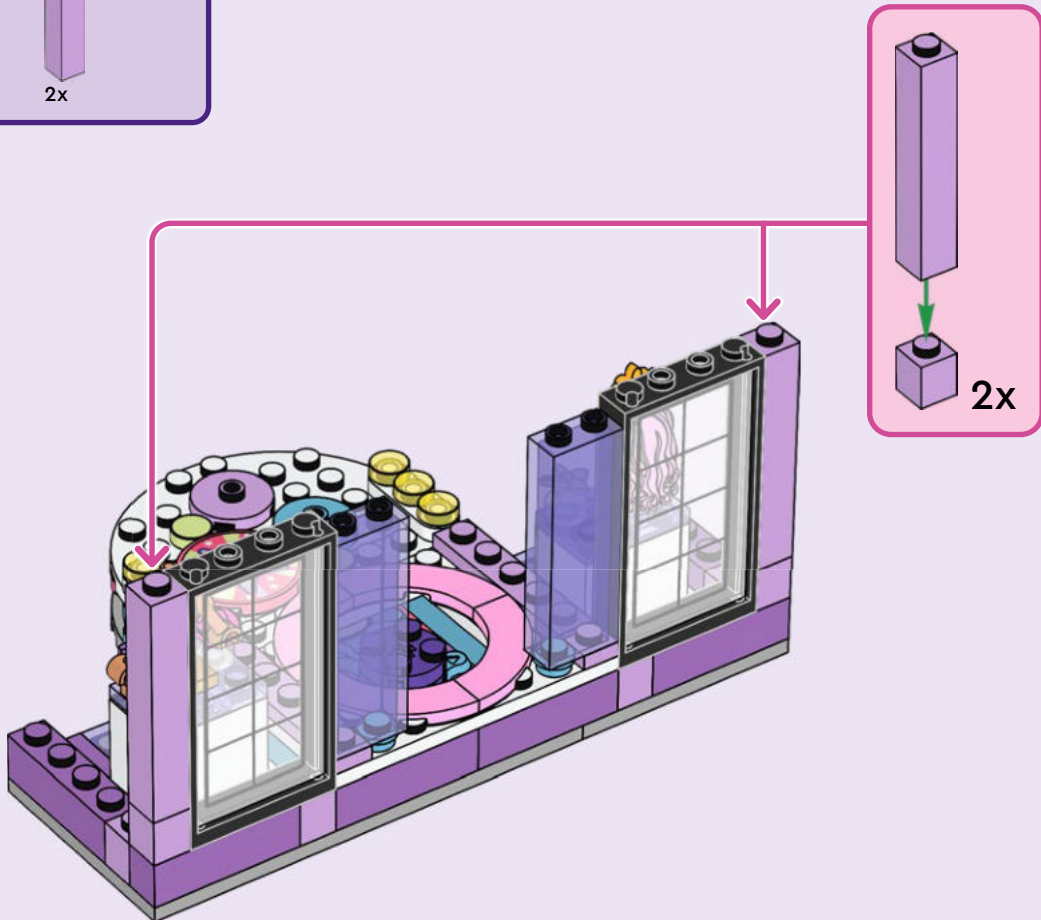

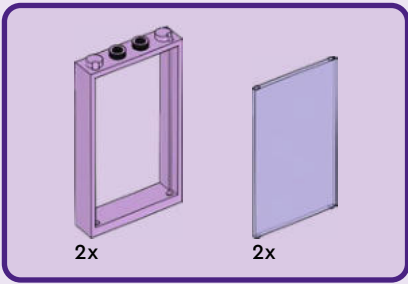

36

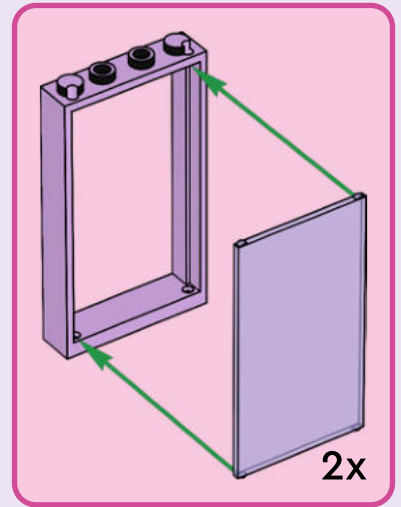

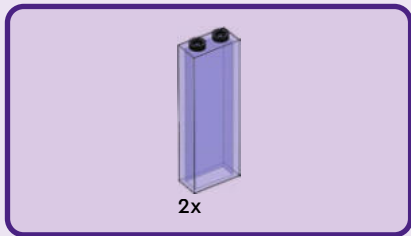

37



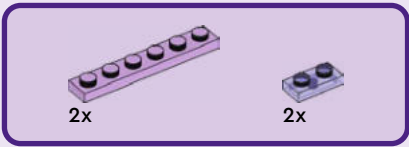

38

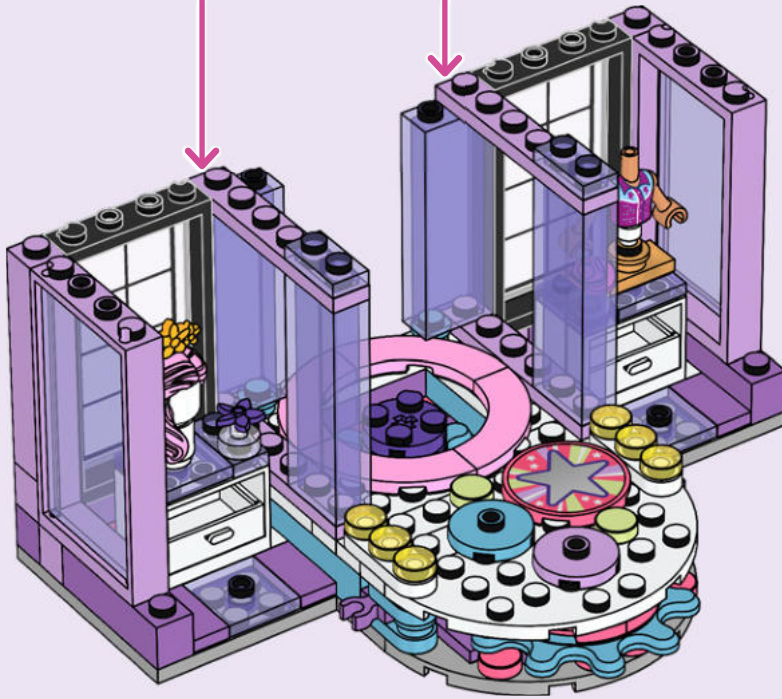
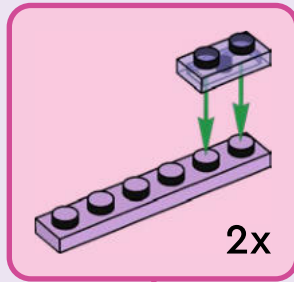



4x

39



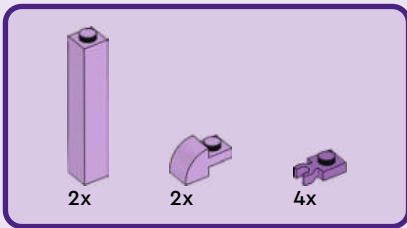

40

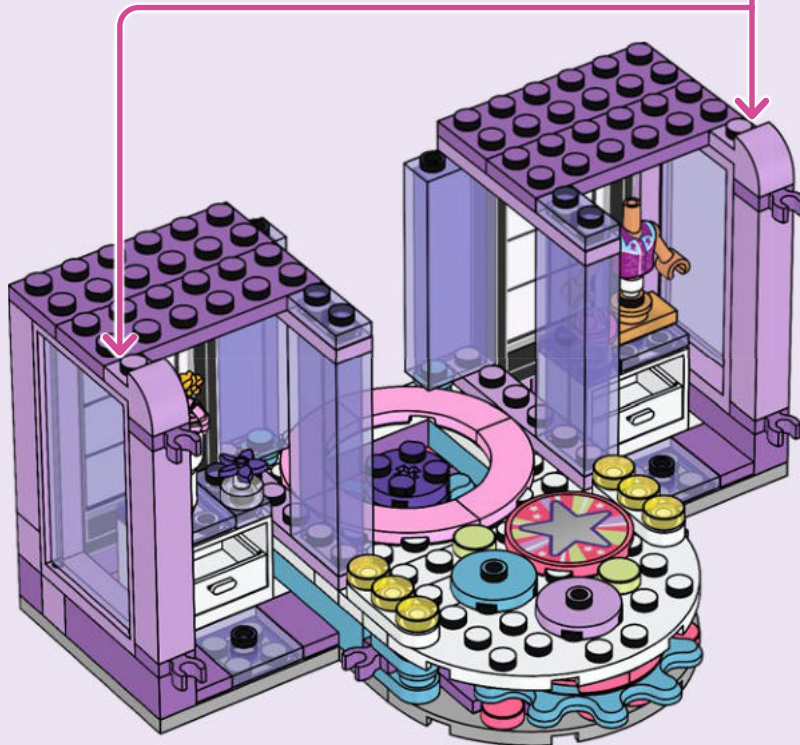
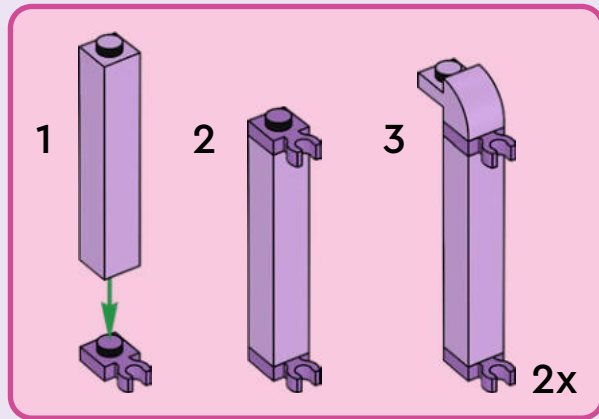



2x



2x

41

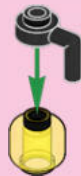

2x

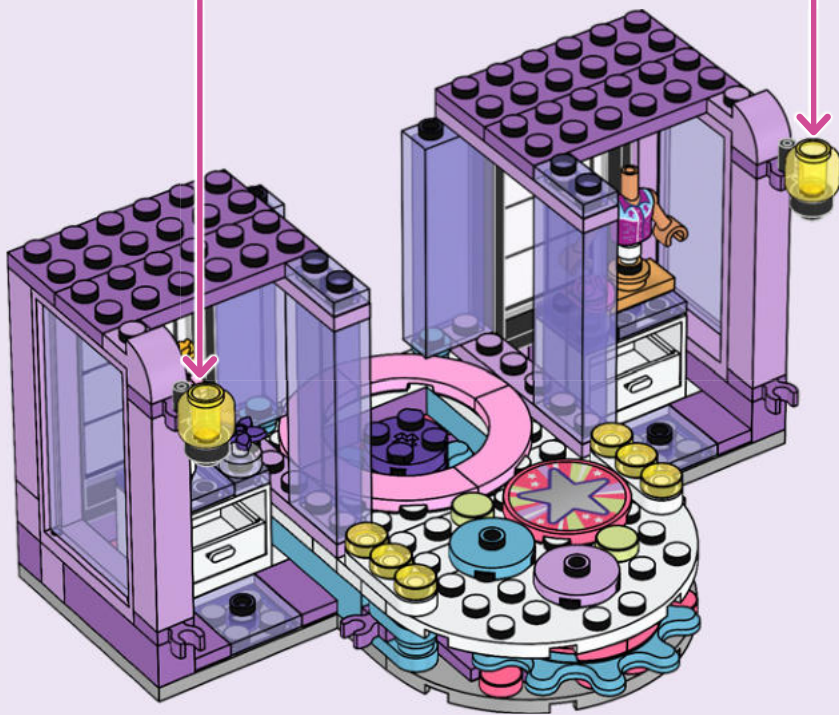

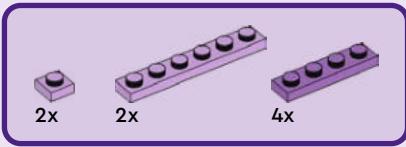

42

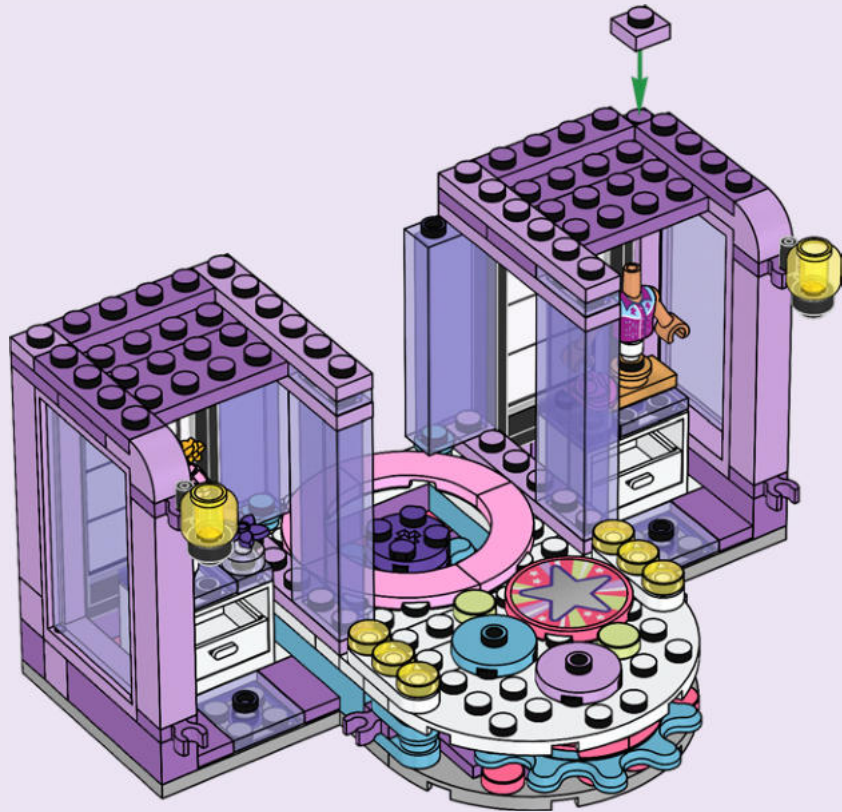



43

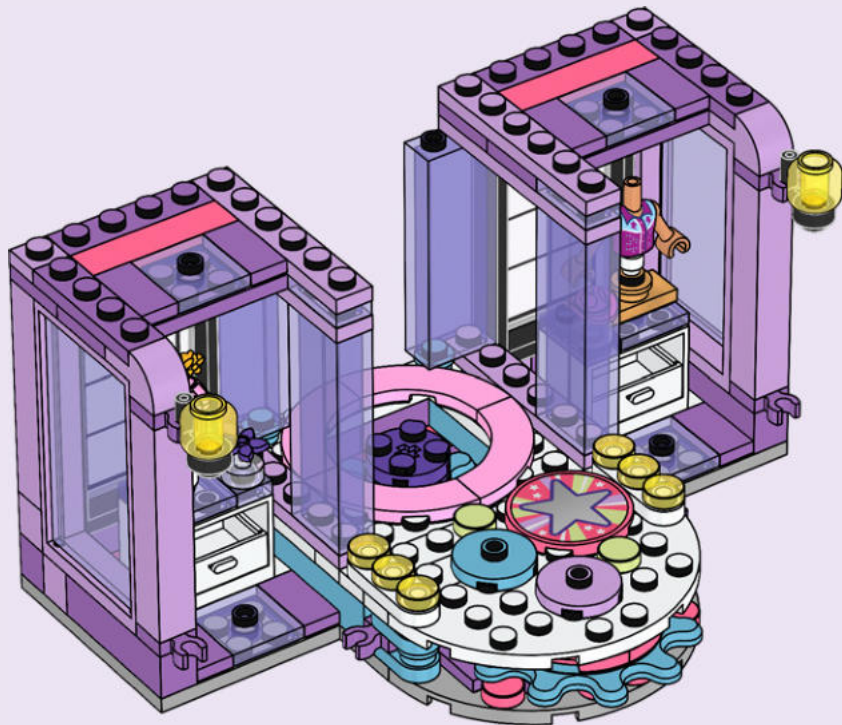



2x

44

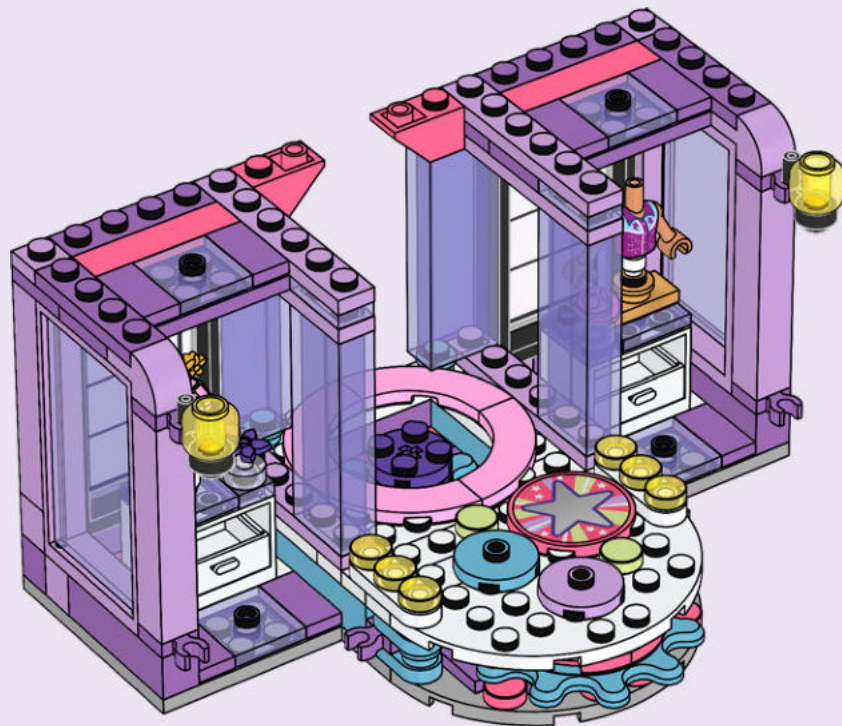

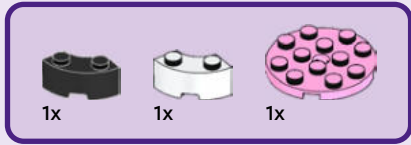

45

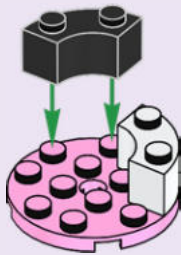

46

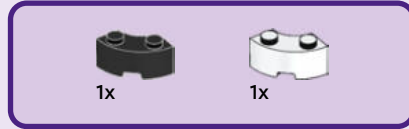

47





1x



1x

48



1x



1x

49

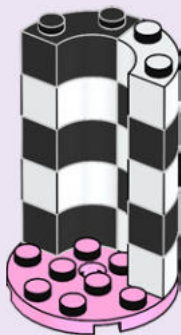

1x



2x

50





1x



2x

51

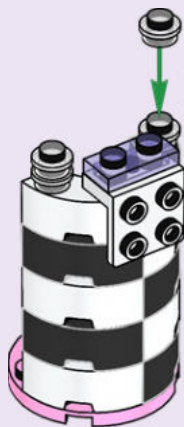

2x

52





53

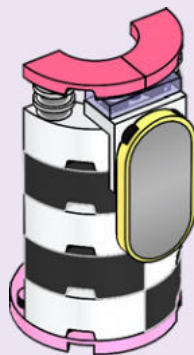
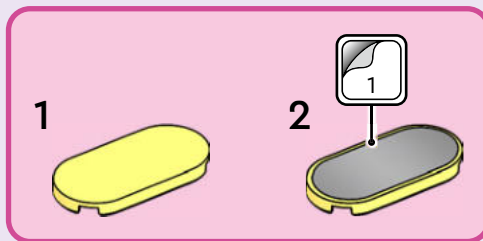

54

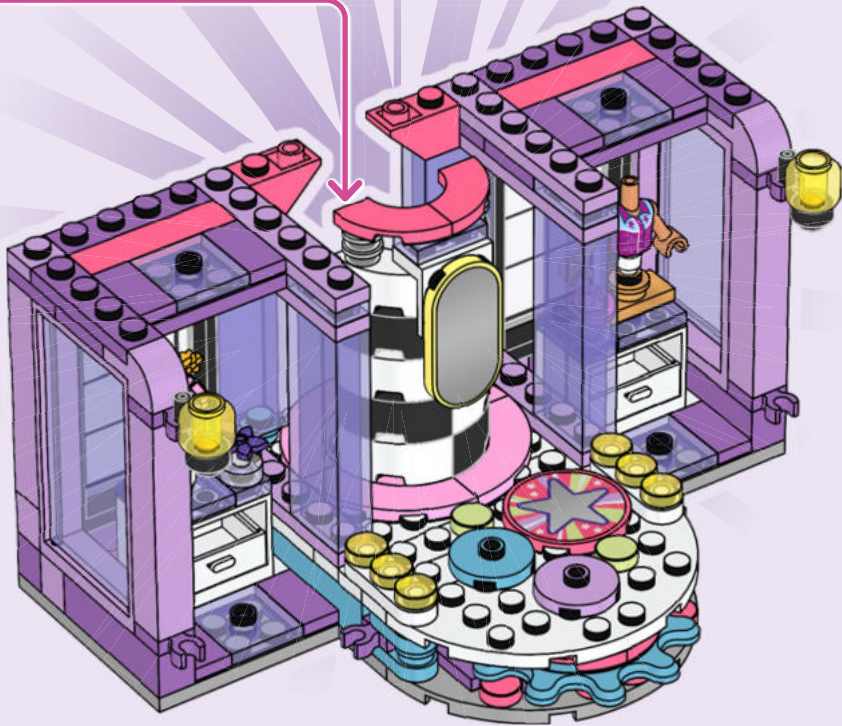

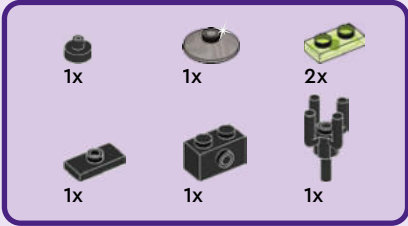

55

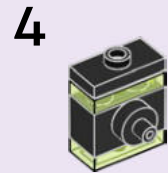
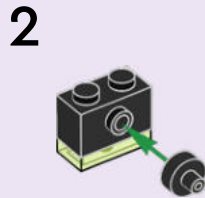
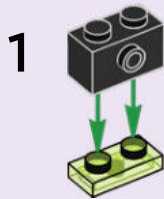

5

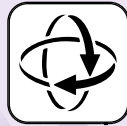

6

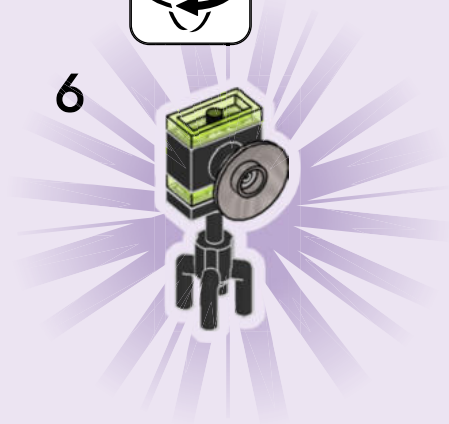

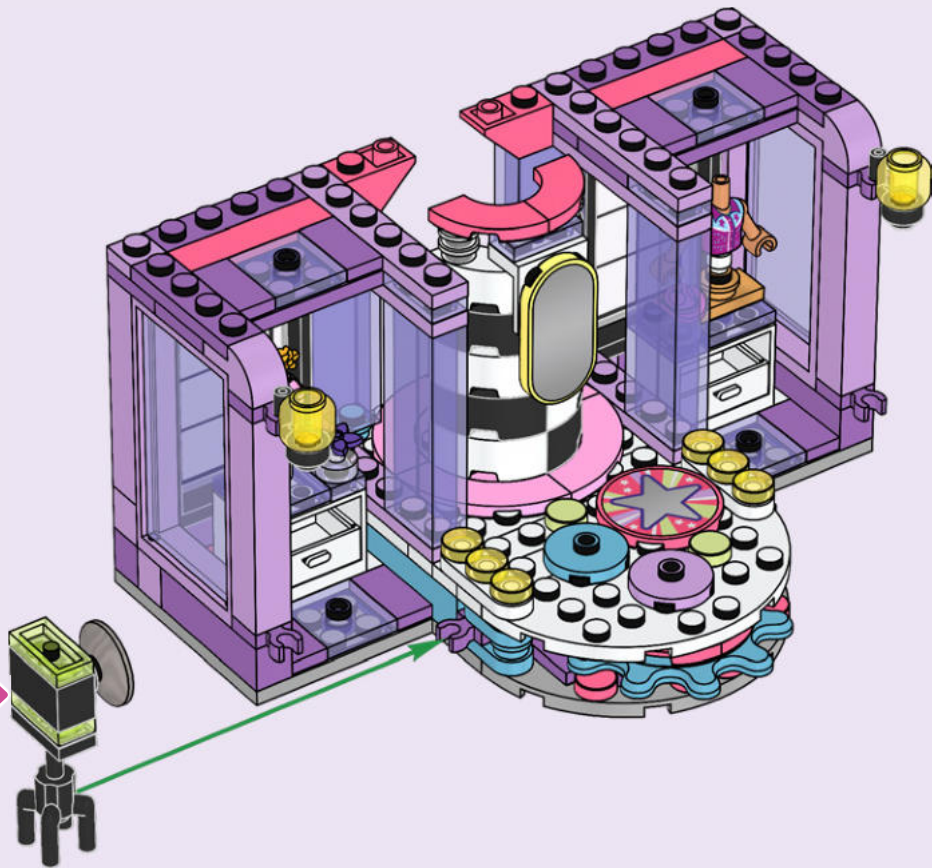

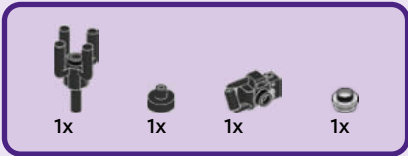

56

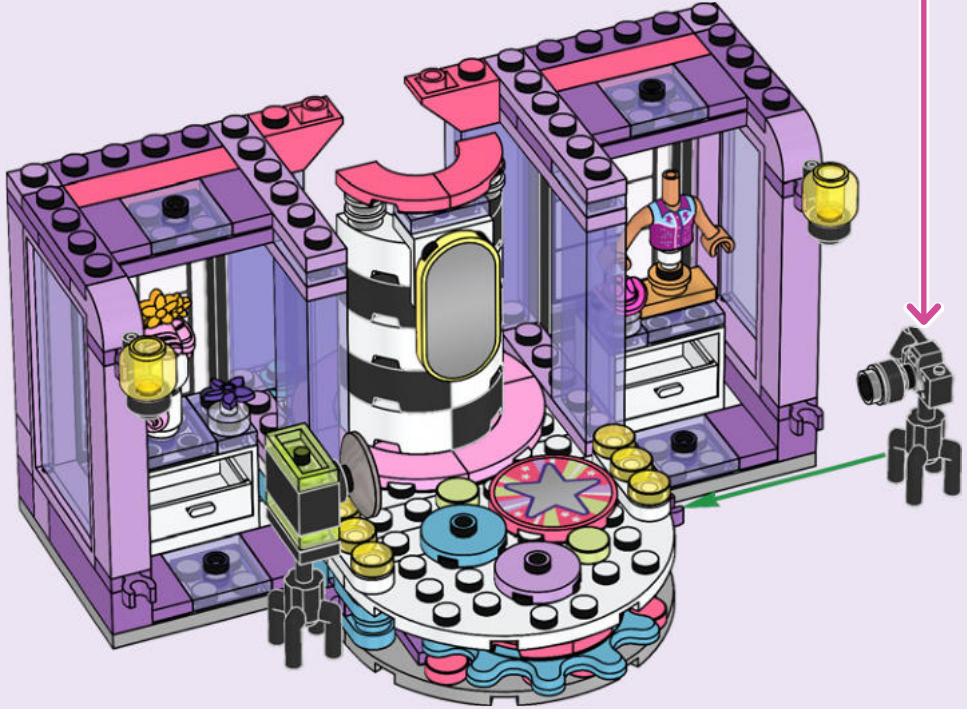
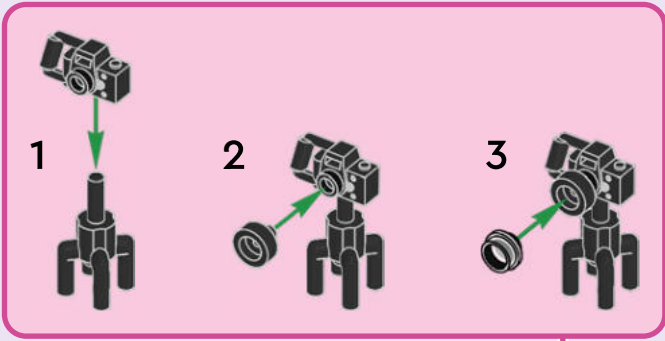



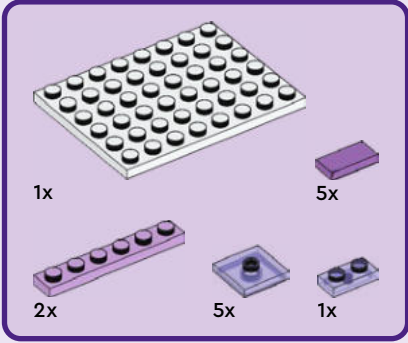
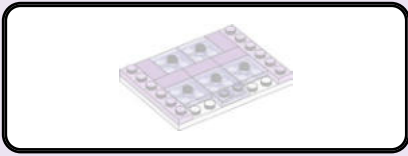

57

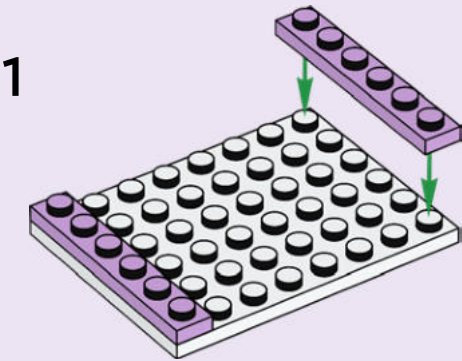

2

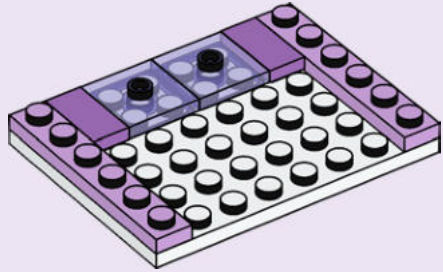

3

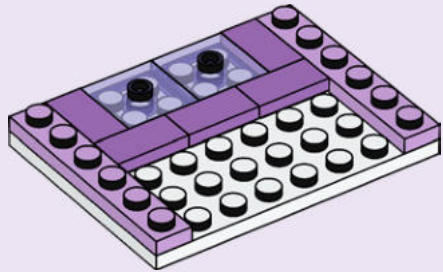

4

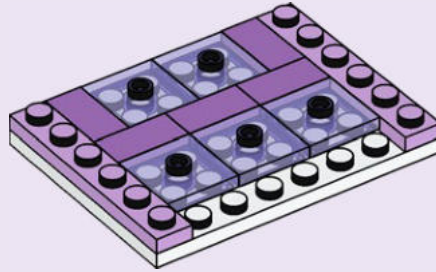

5

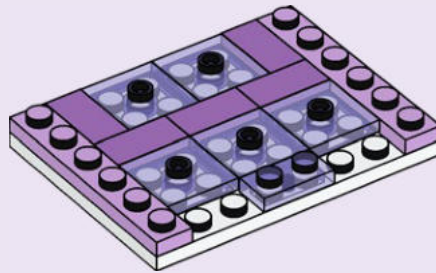

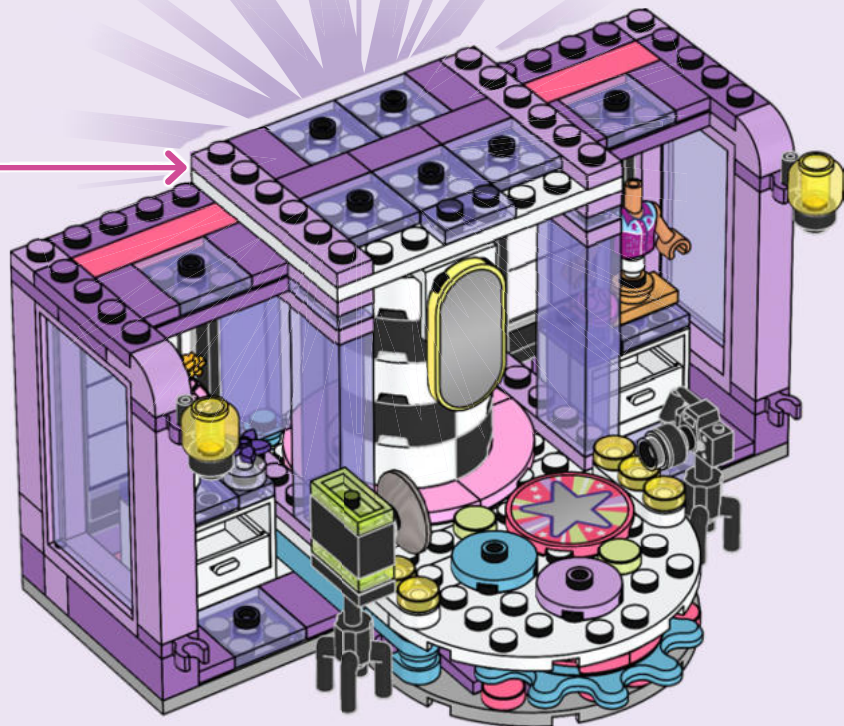

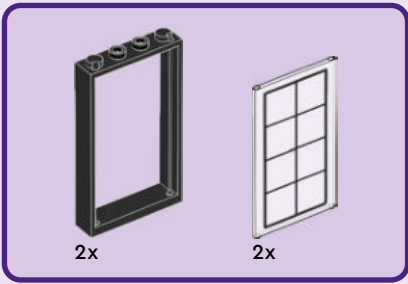

58

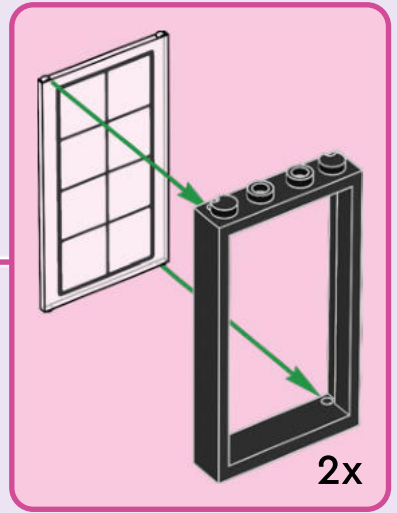
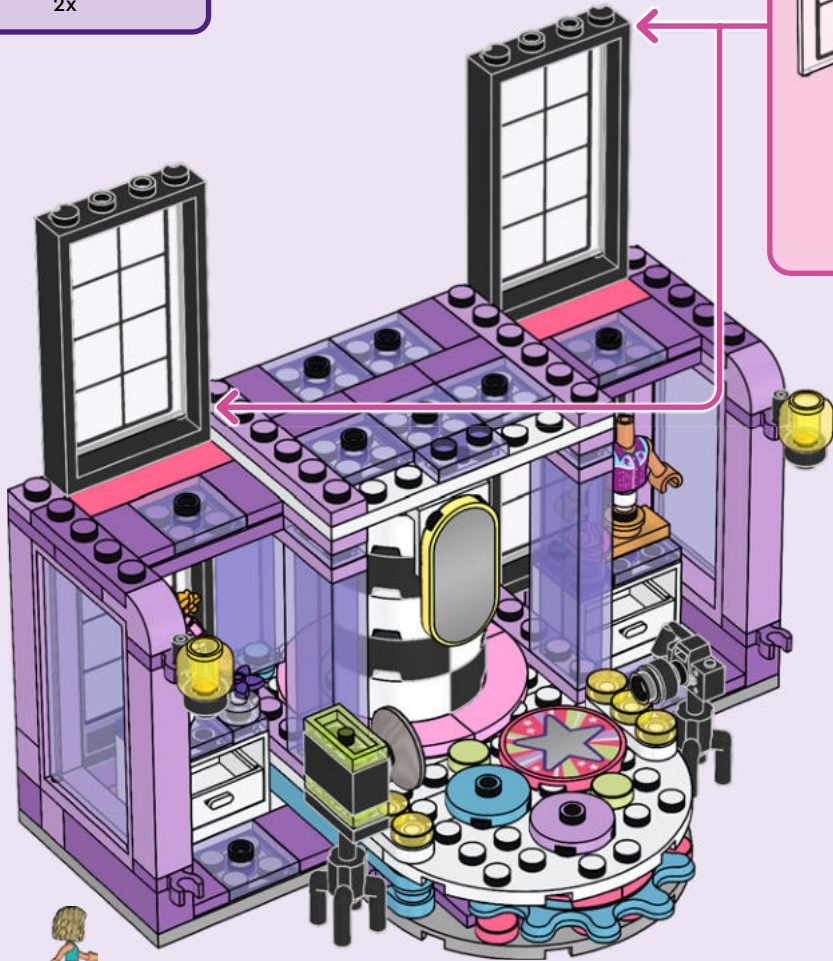

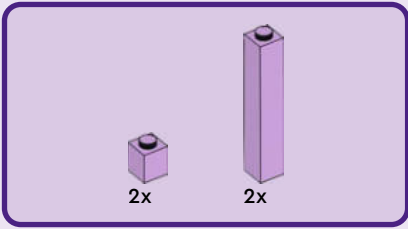

59

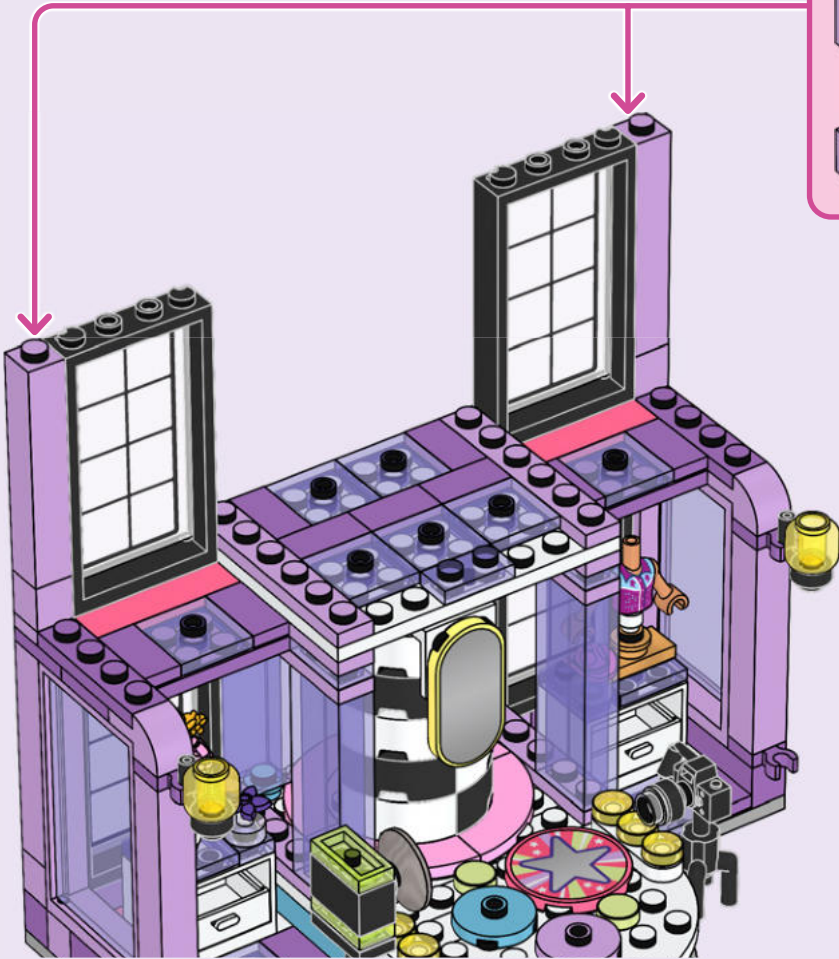
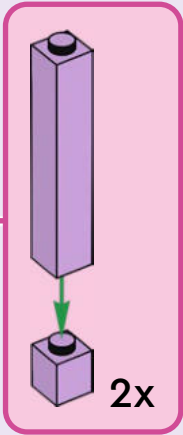

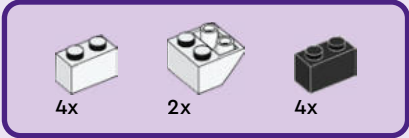
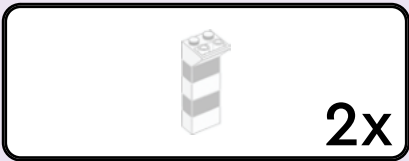

60

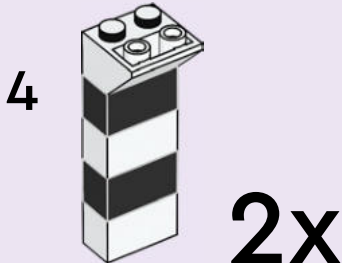
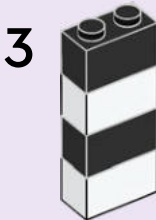
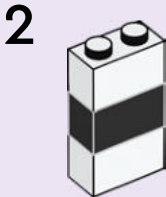
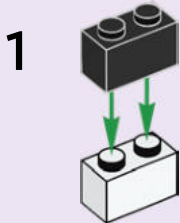

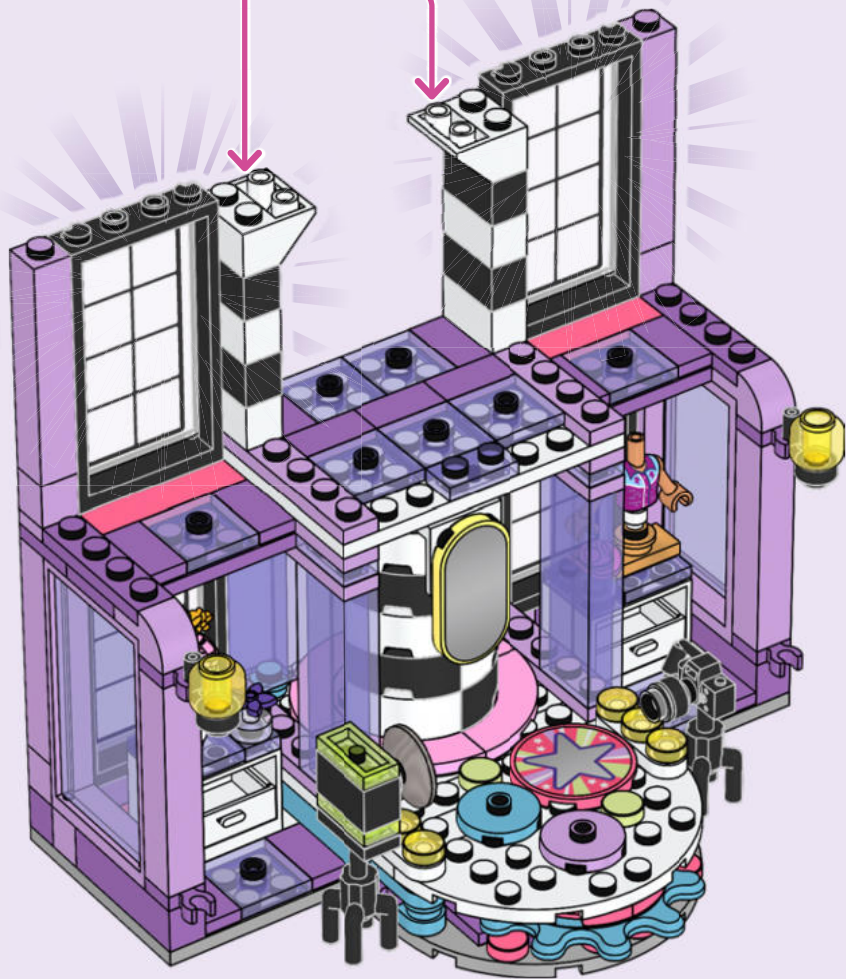

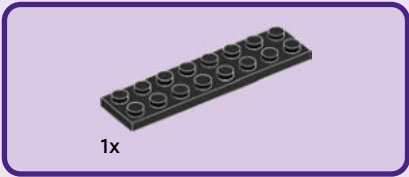

61

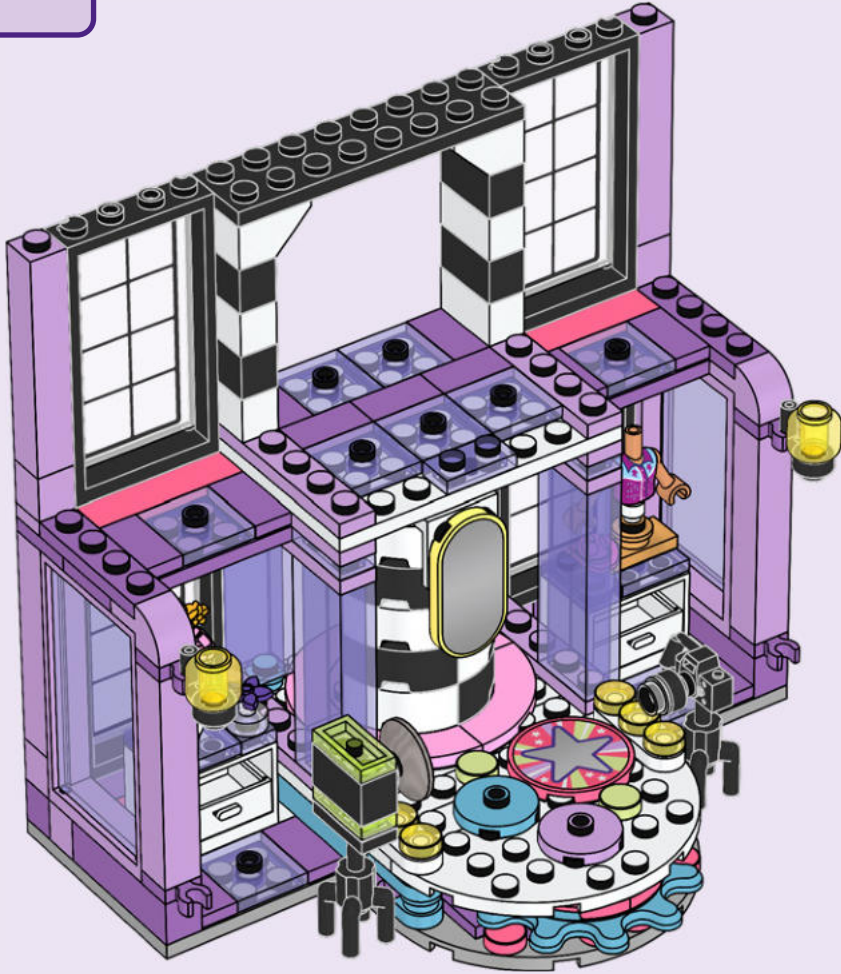

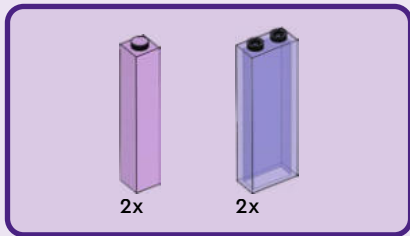

62

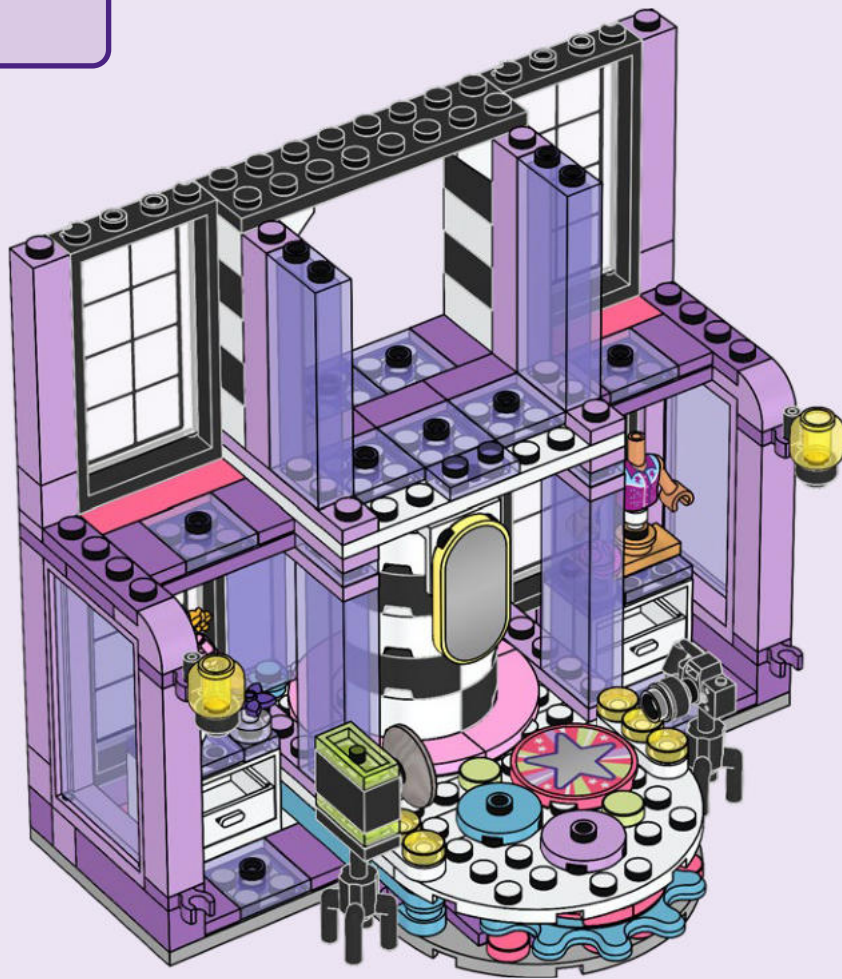



2x



2x

63

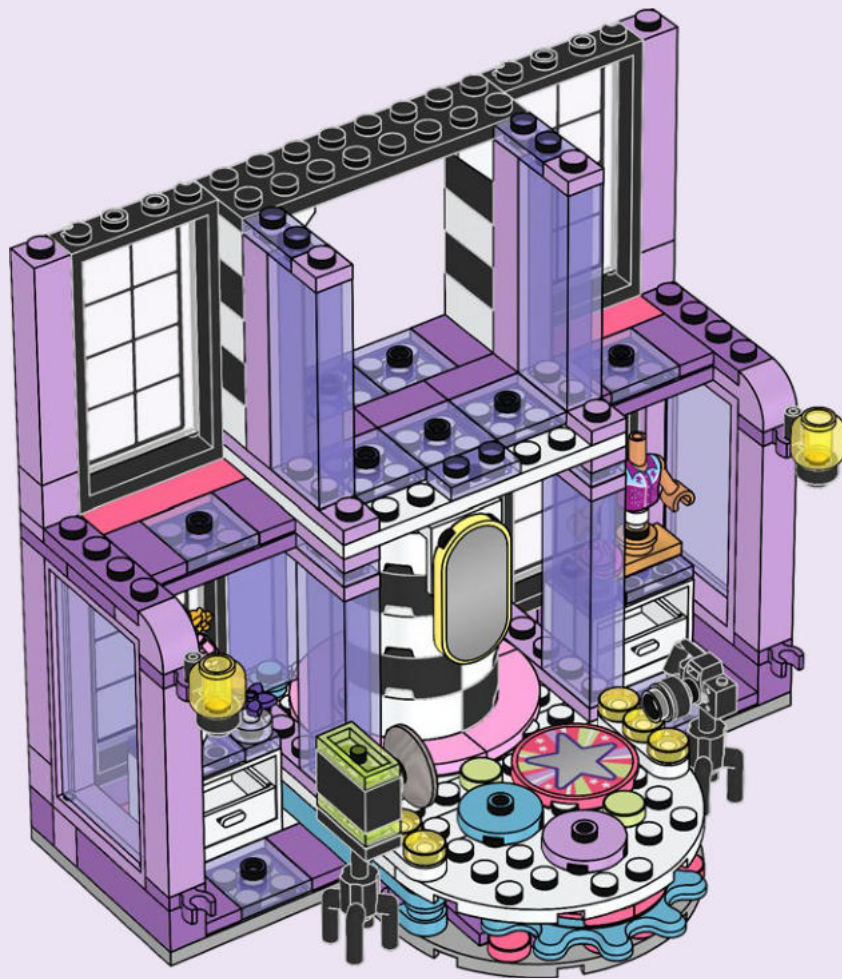

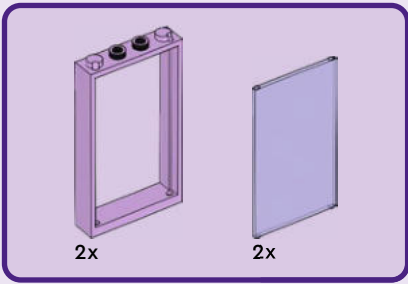

64

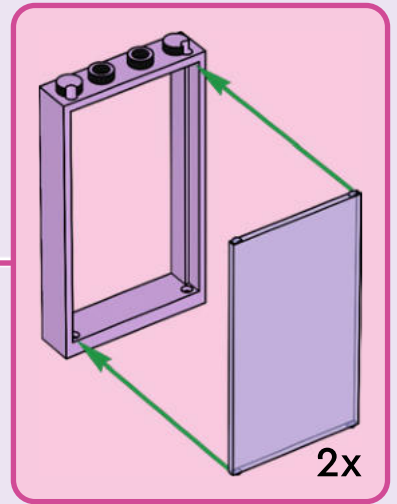
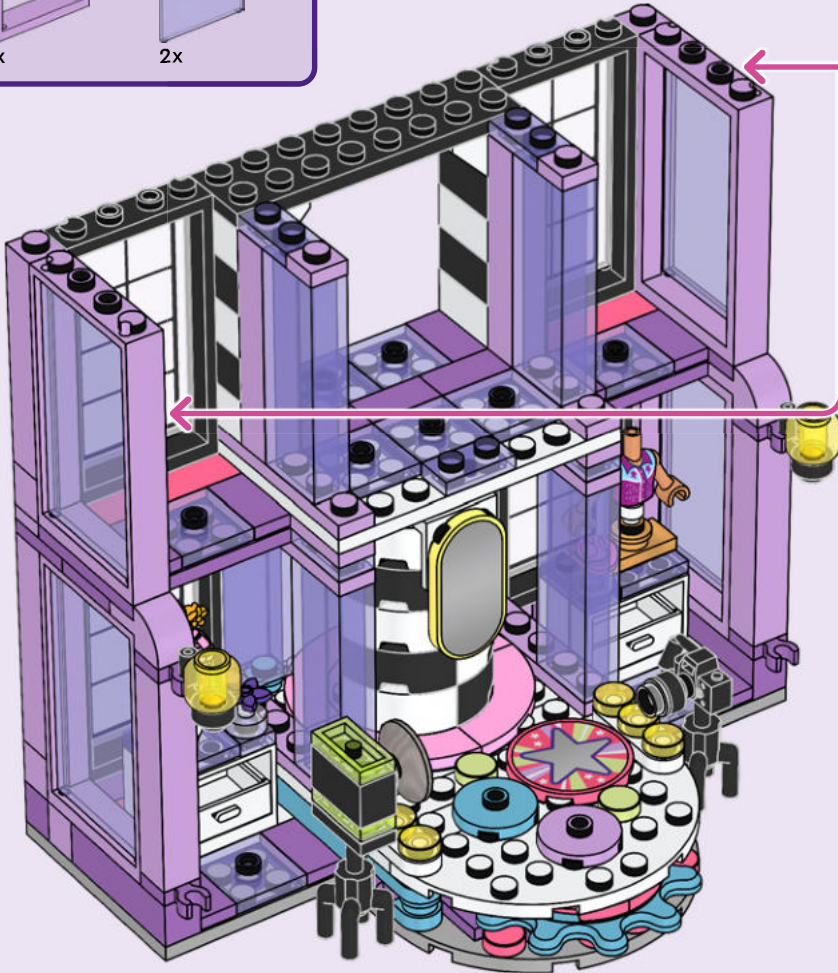



2x

65

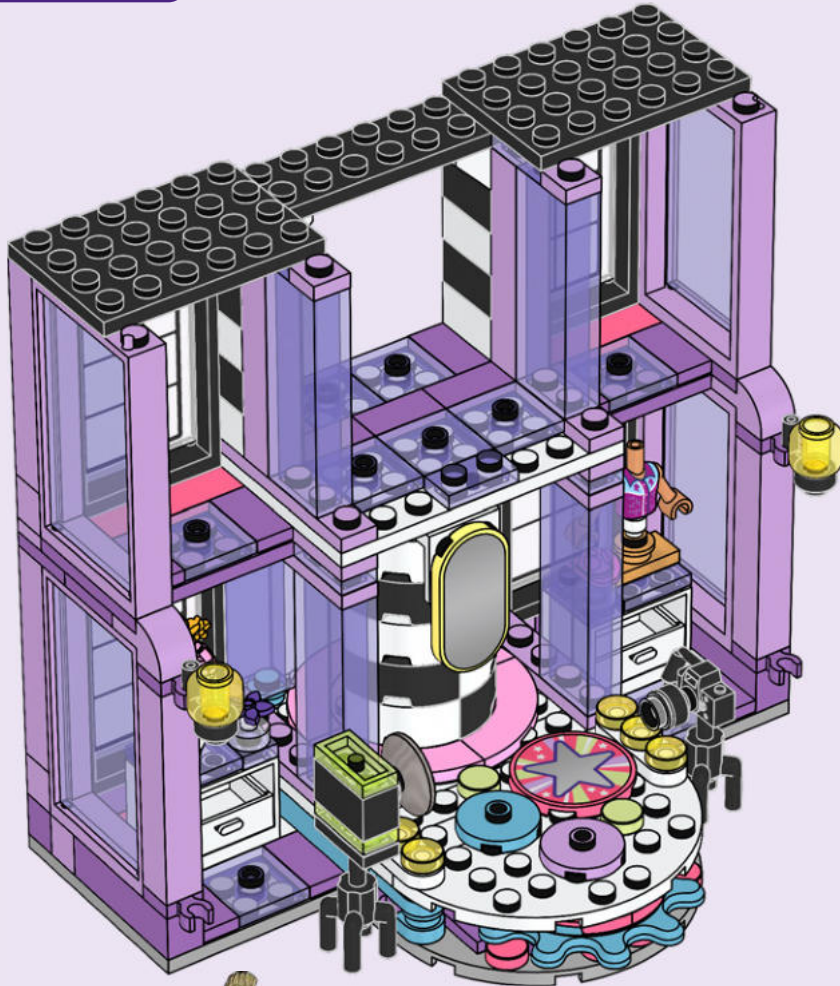

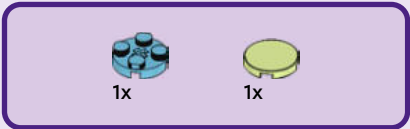

66

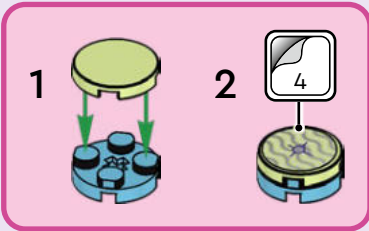

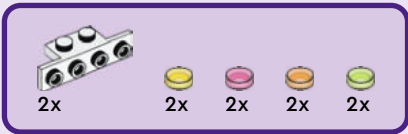

67

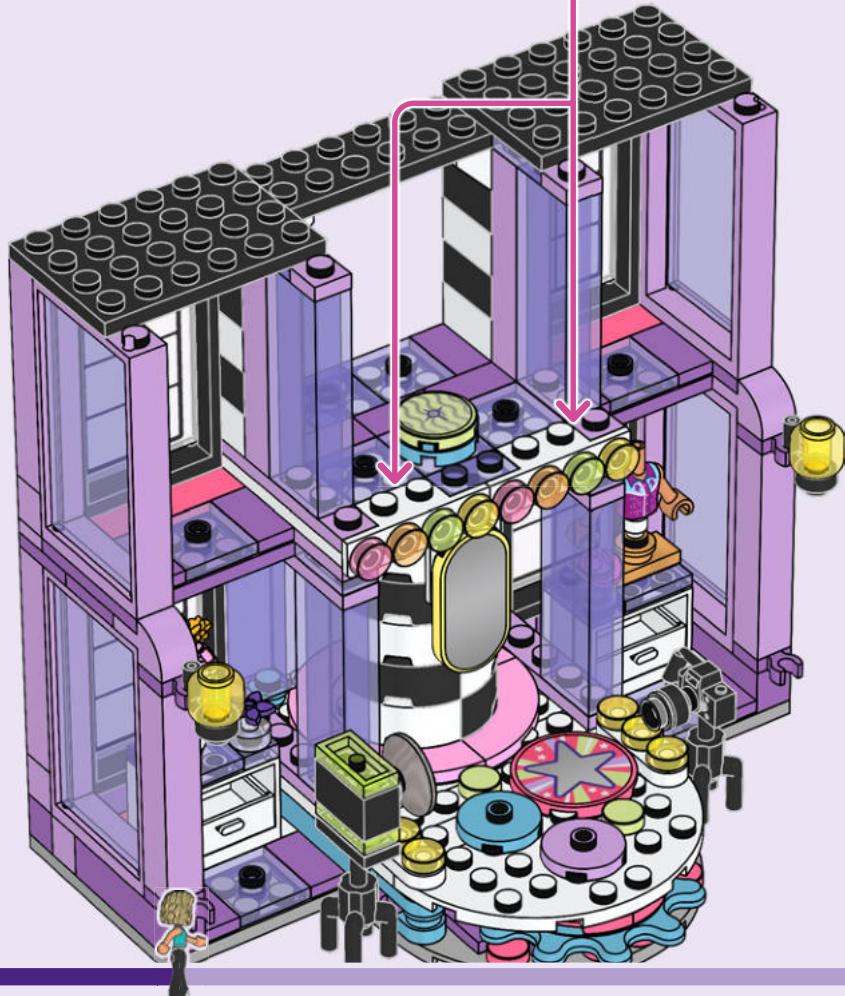
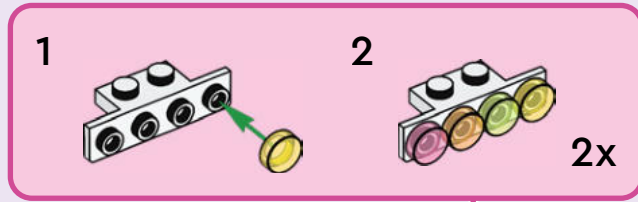



8x

68

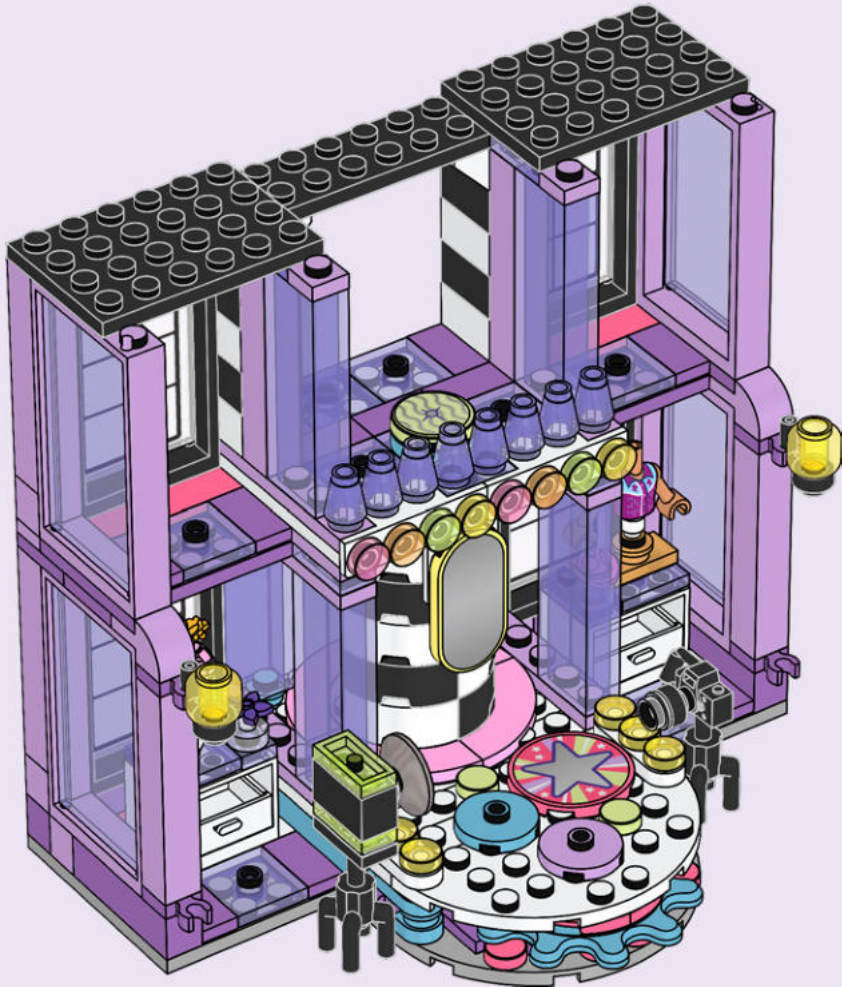



69

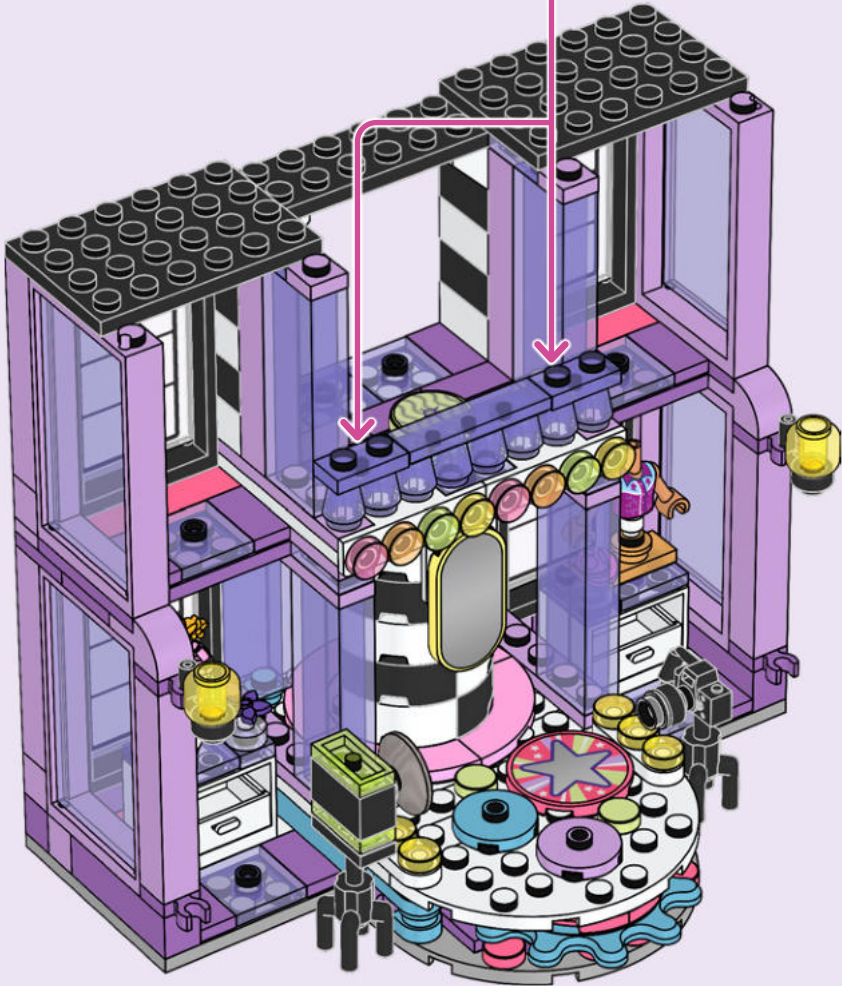



70

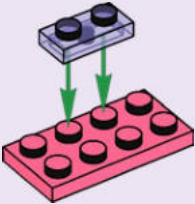

71

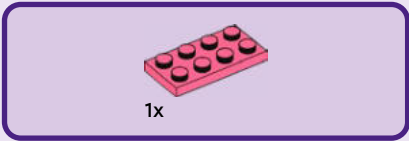
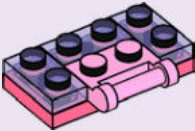

72

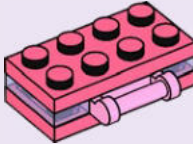

73

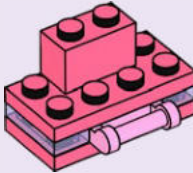

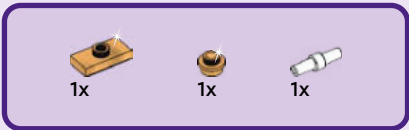

74

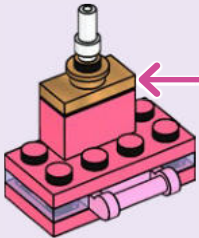
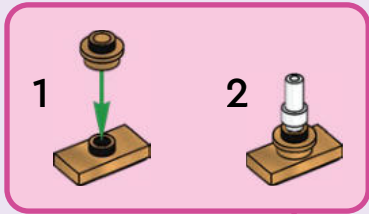

75

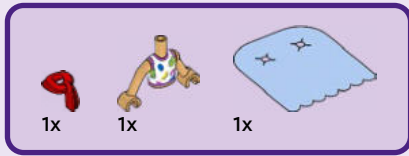
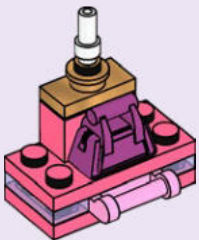

76

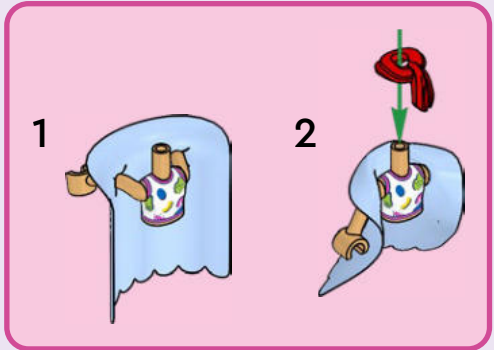

77

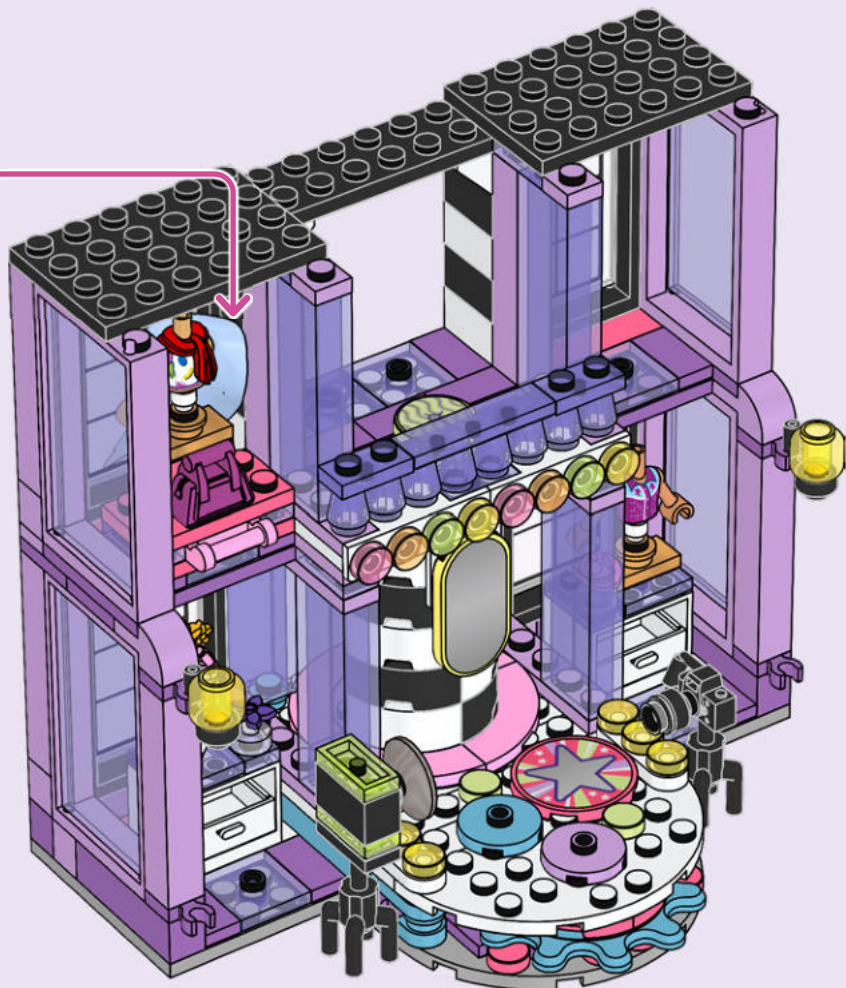

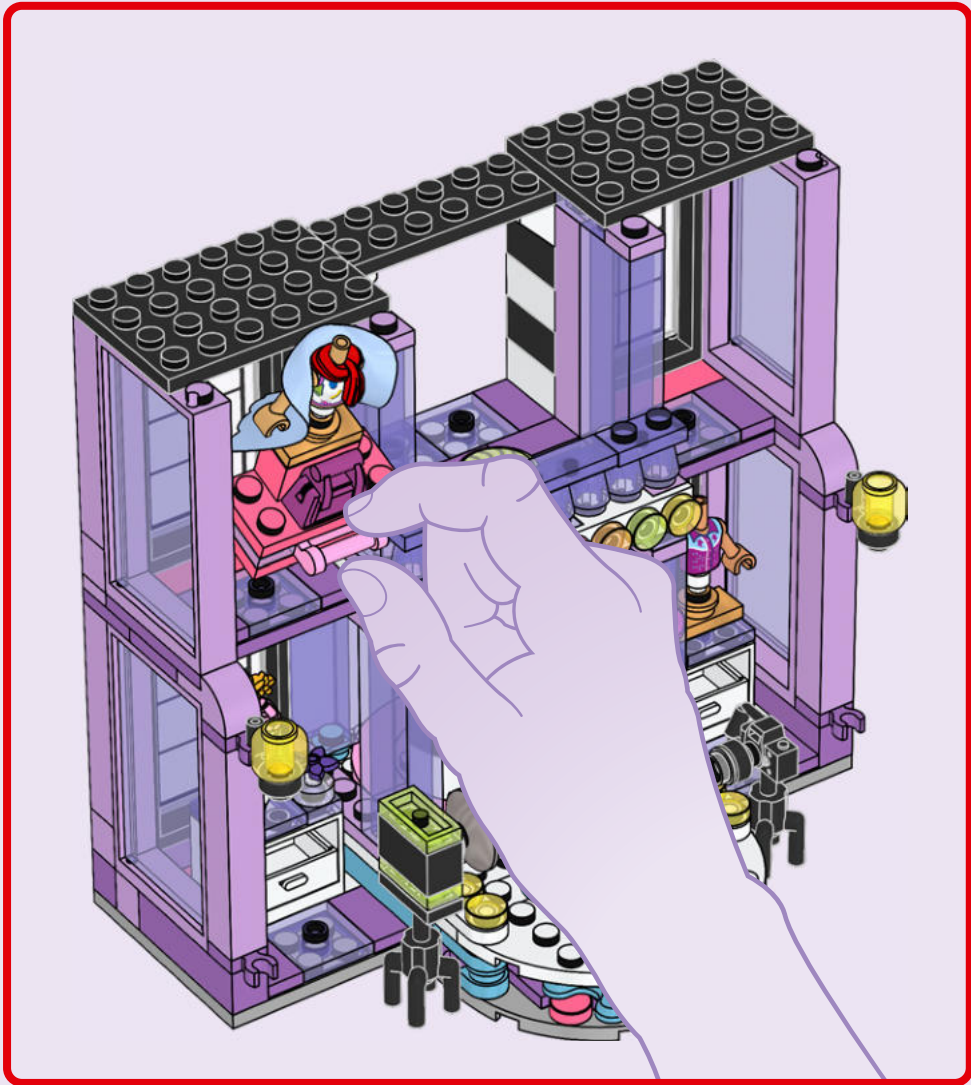

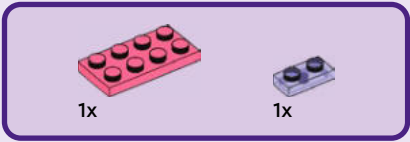

78

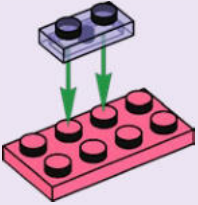

79

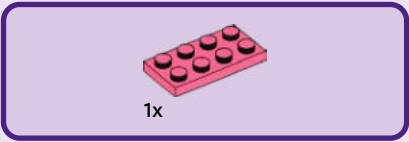
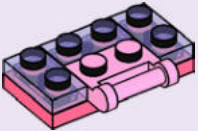

80

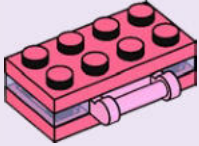

81

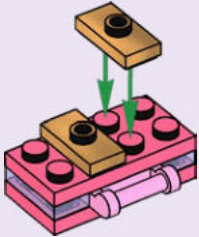

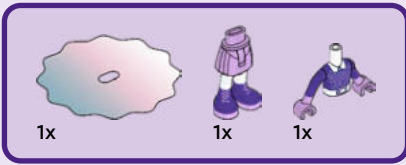

82

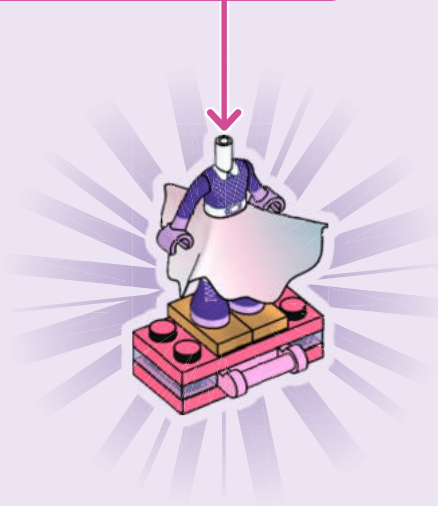
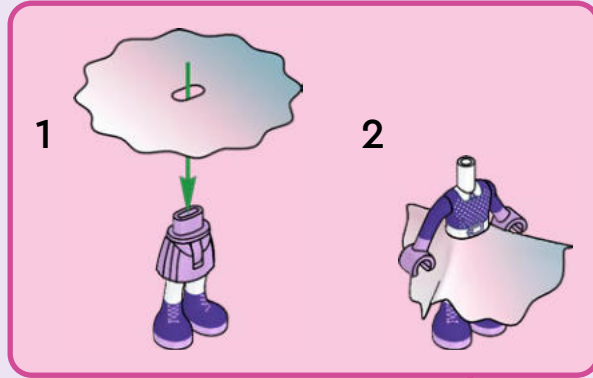

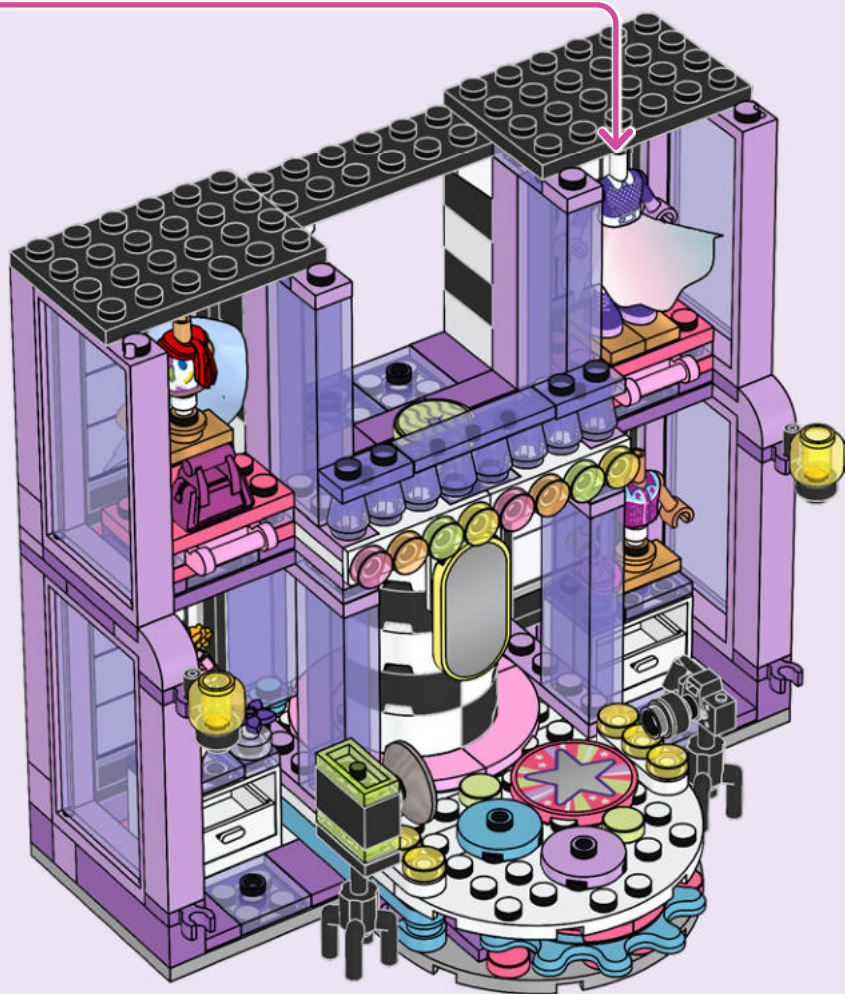

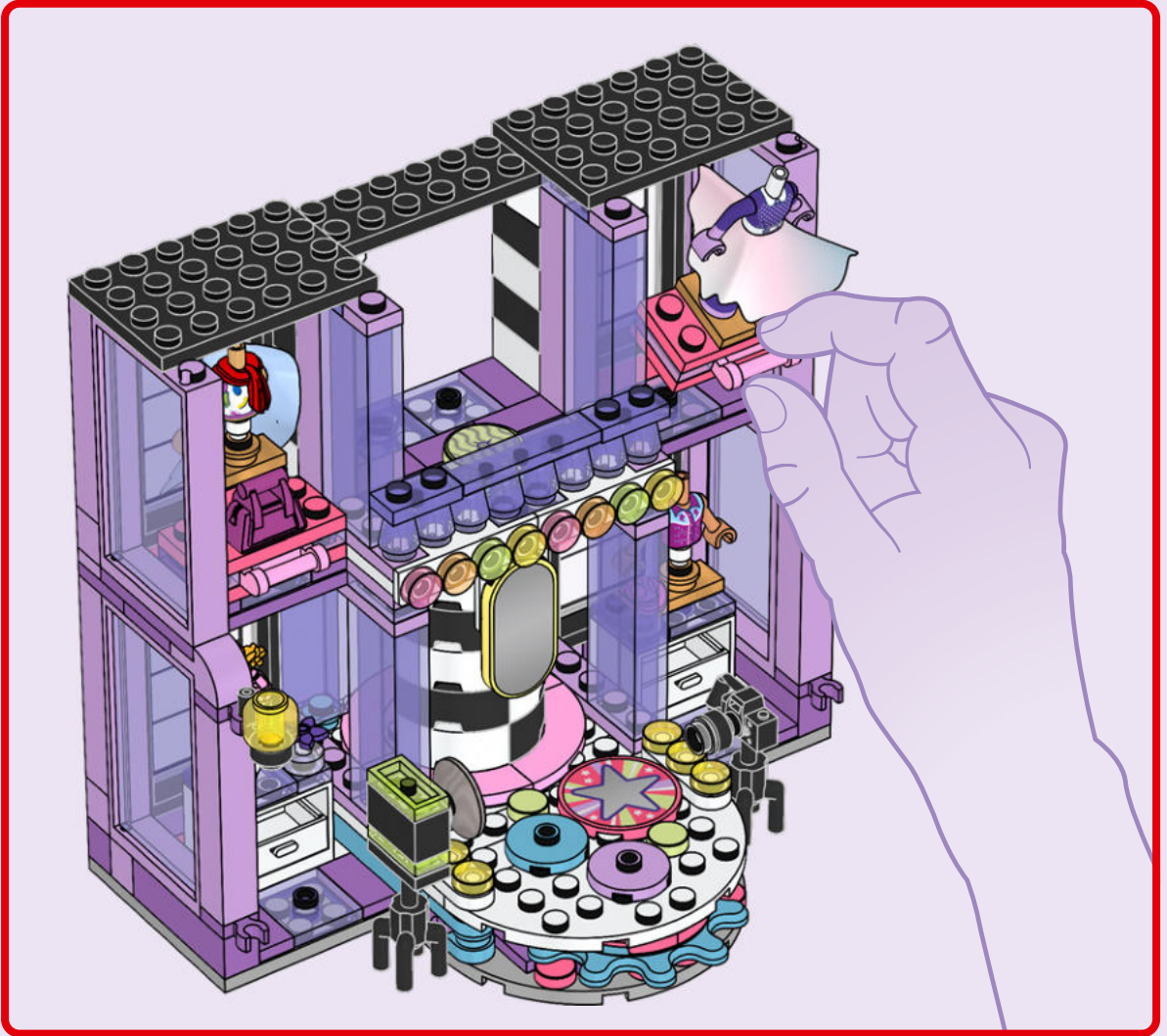





84

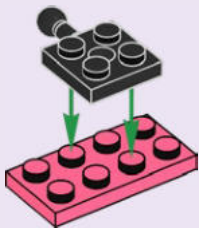

85

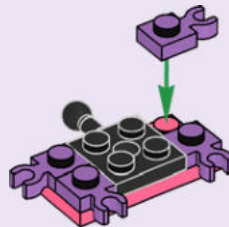

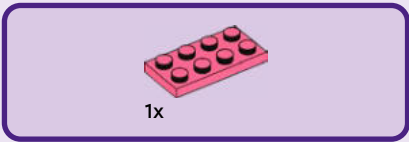

86

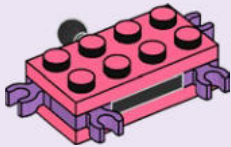

87

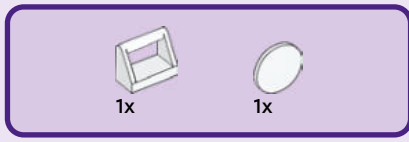
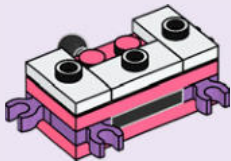

88

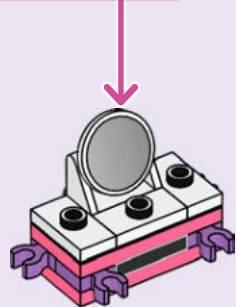
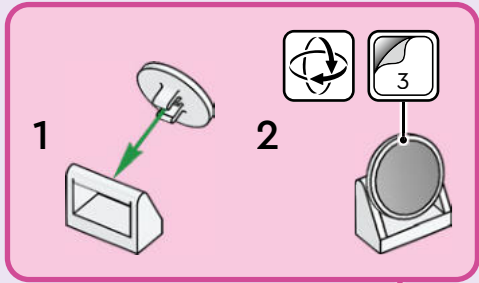



1x



1x

89

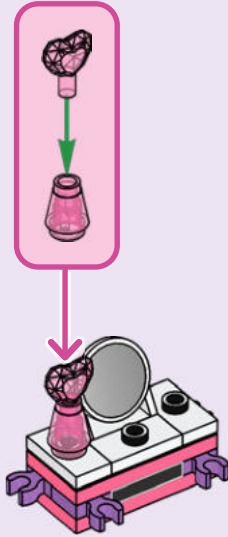

1x



1x

90

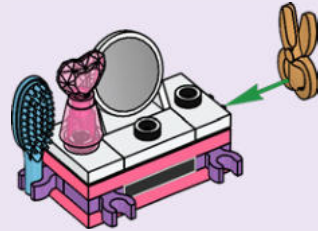

1x



1x

91



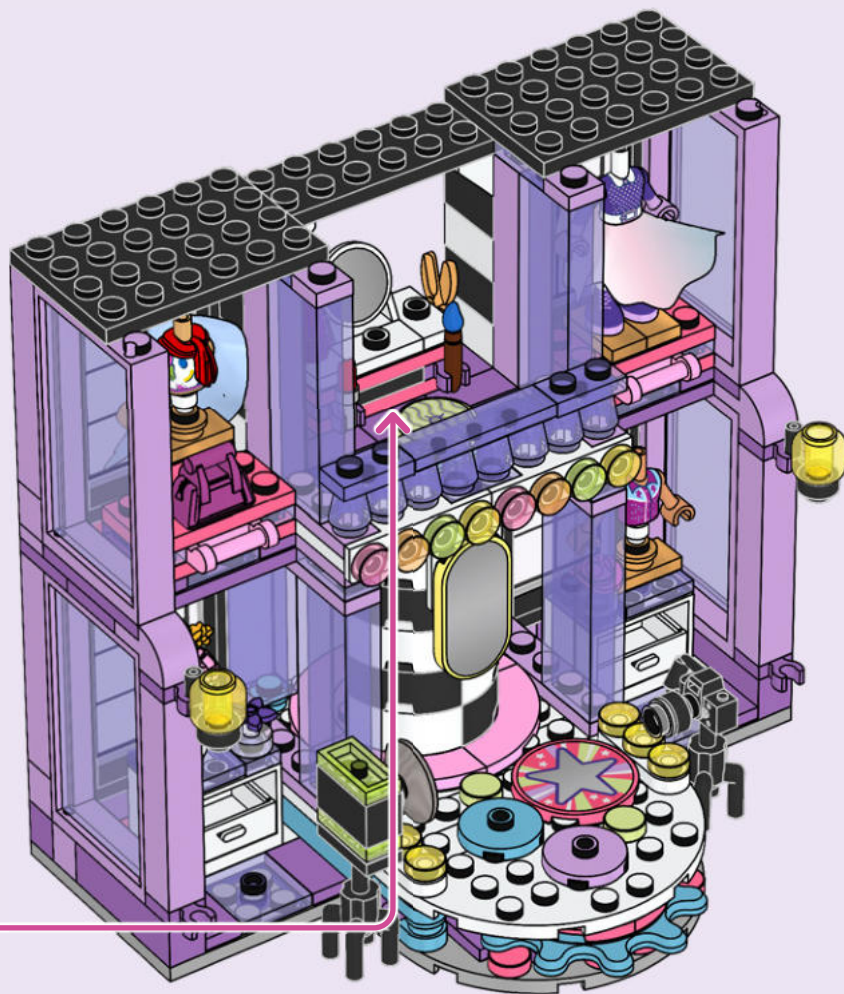

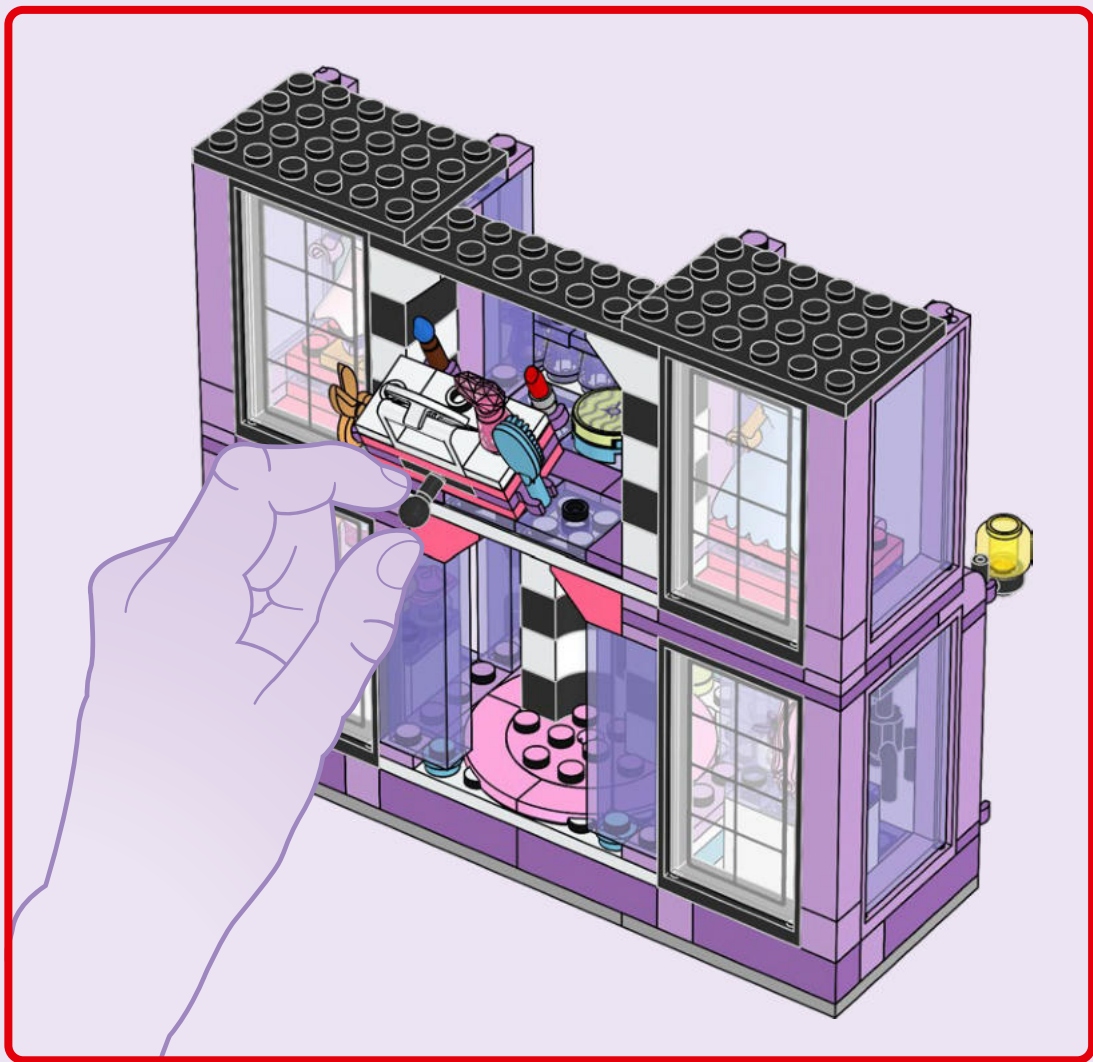



4x

93



4x

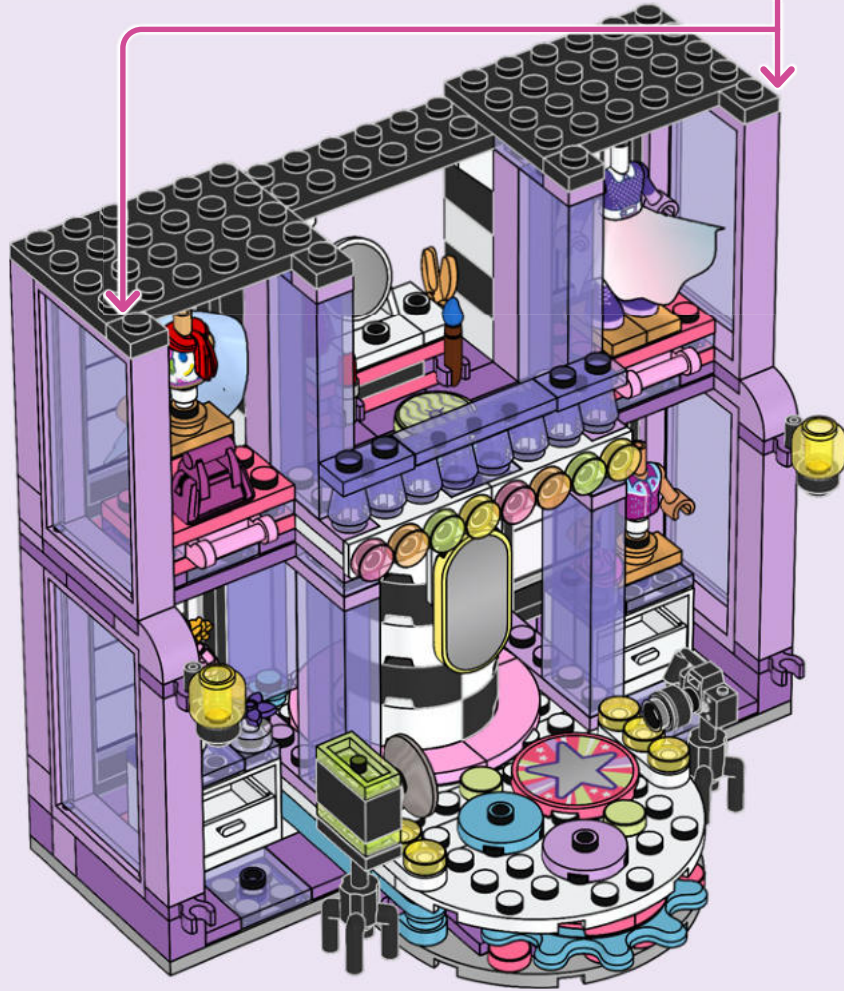



2x

94

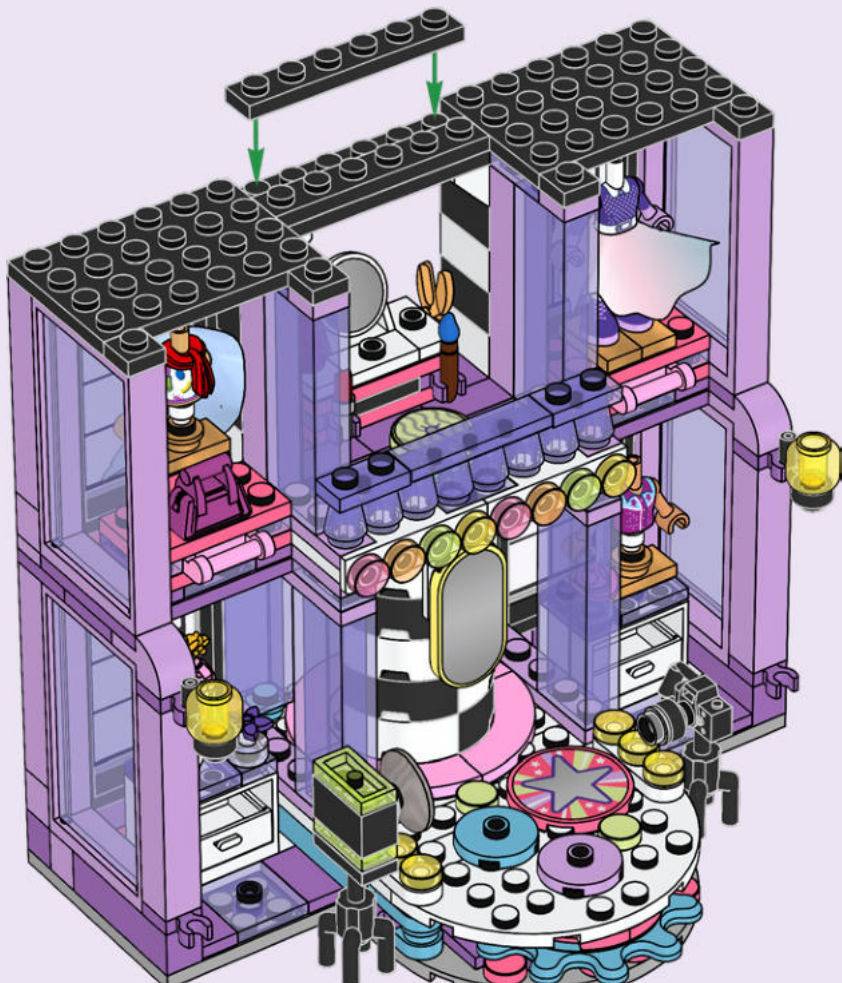



95

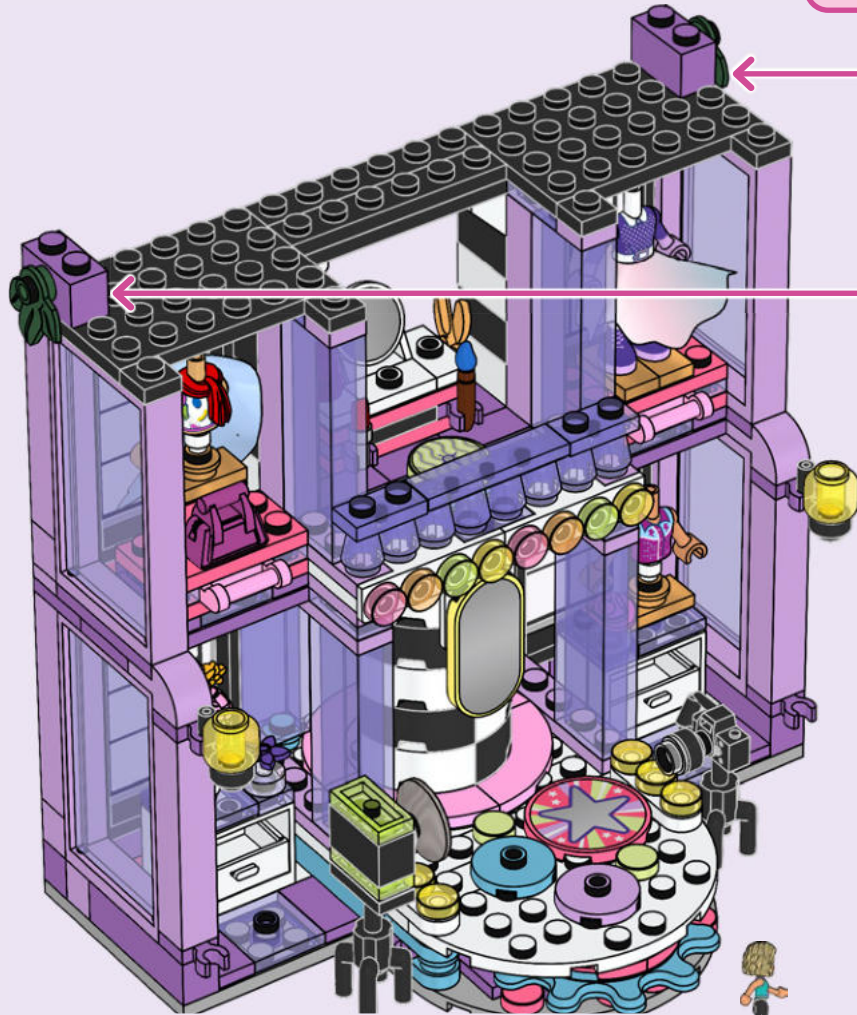
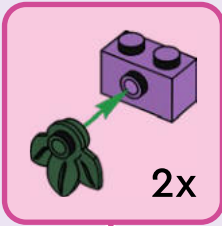

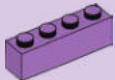

4x

96

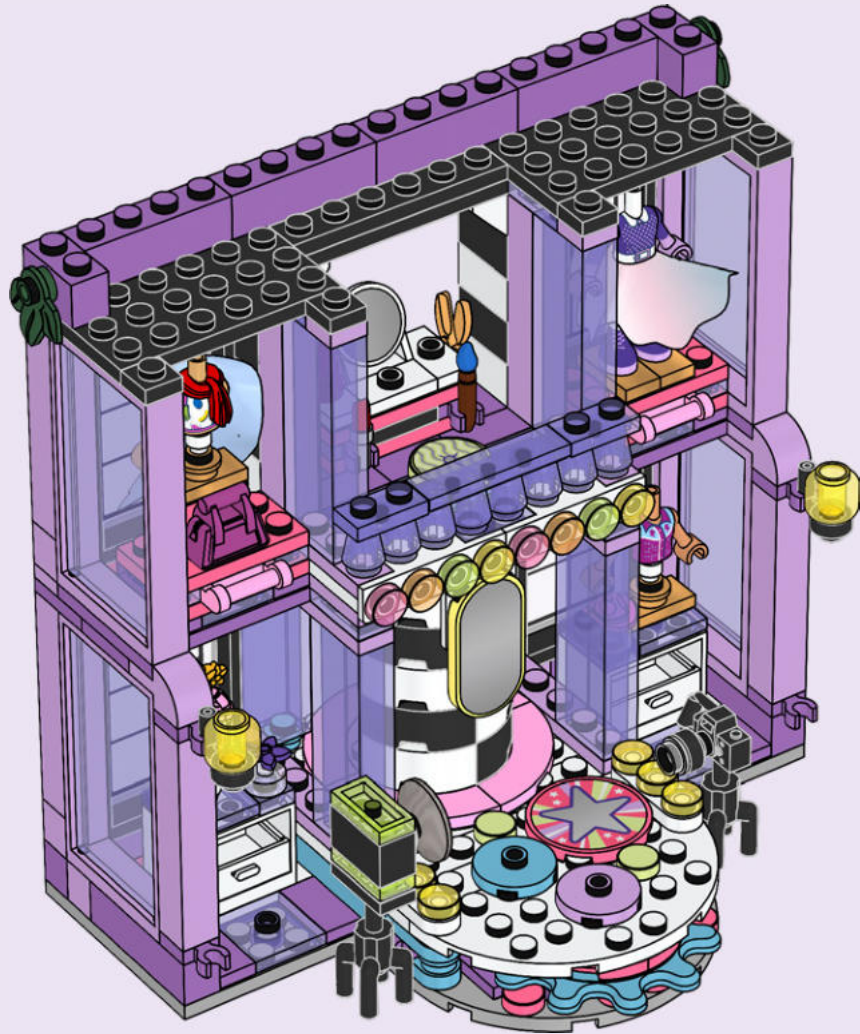

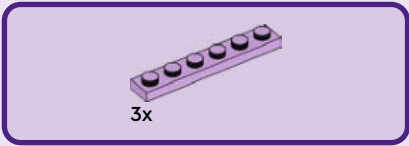

97

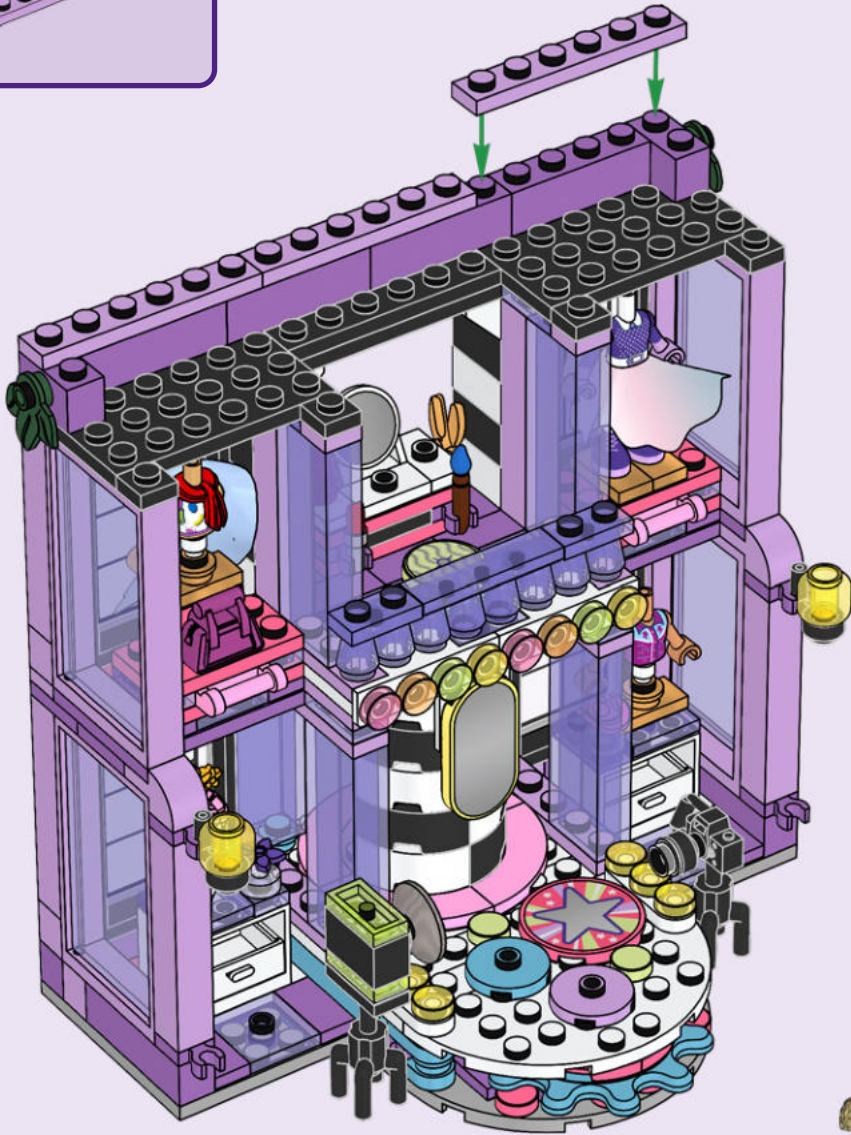



2x



2x



2x



4x



4x



4x



2x

98

1

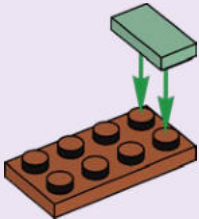

2

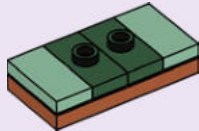

3



4



2x

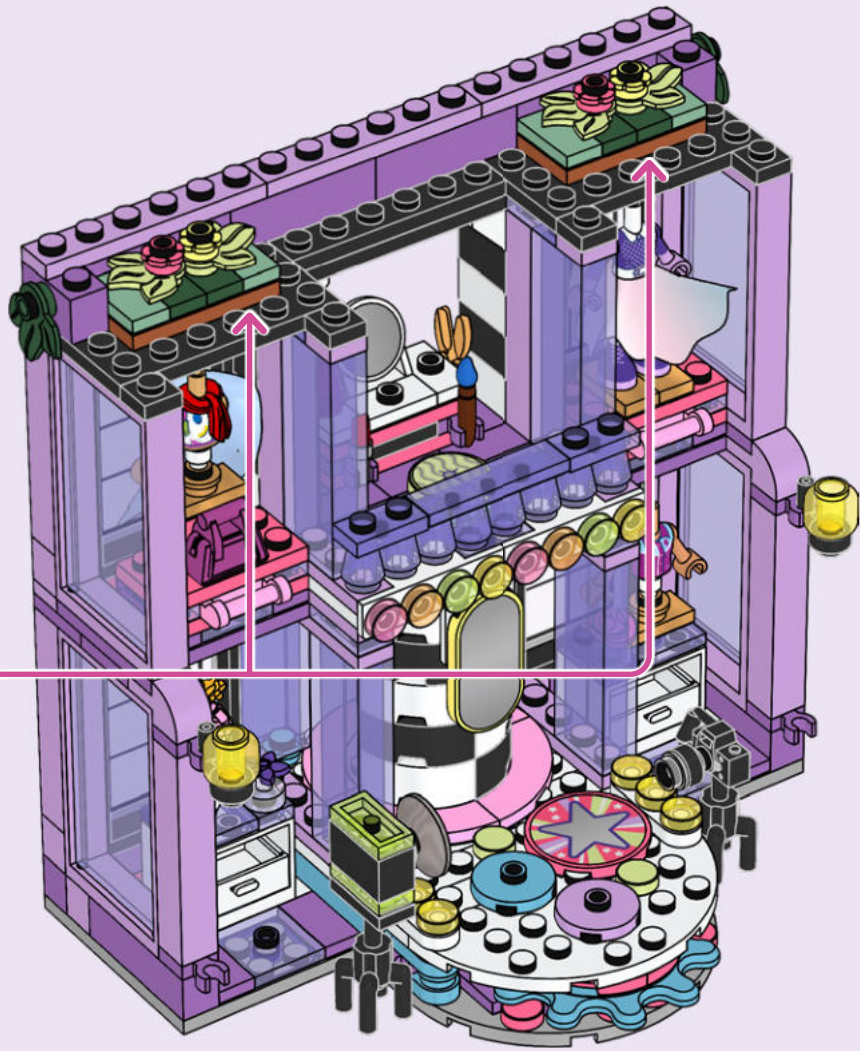



2x



1x

99

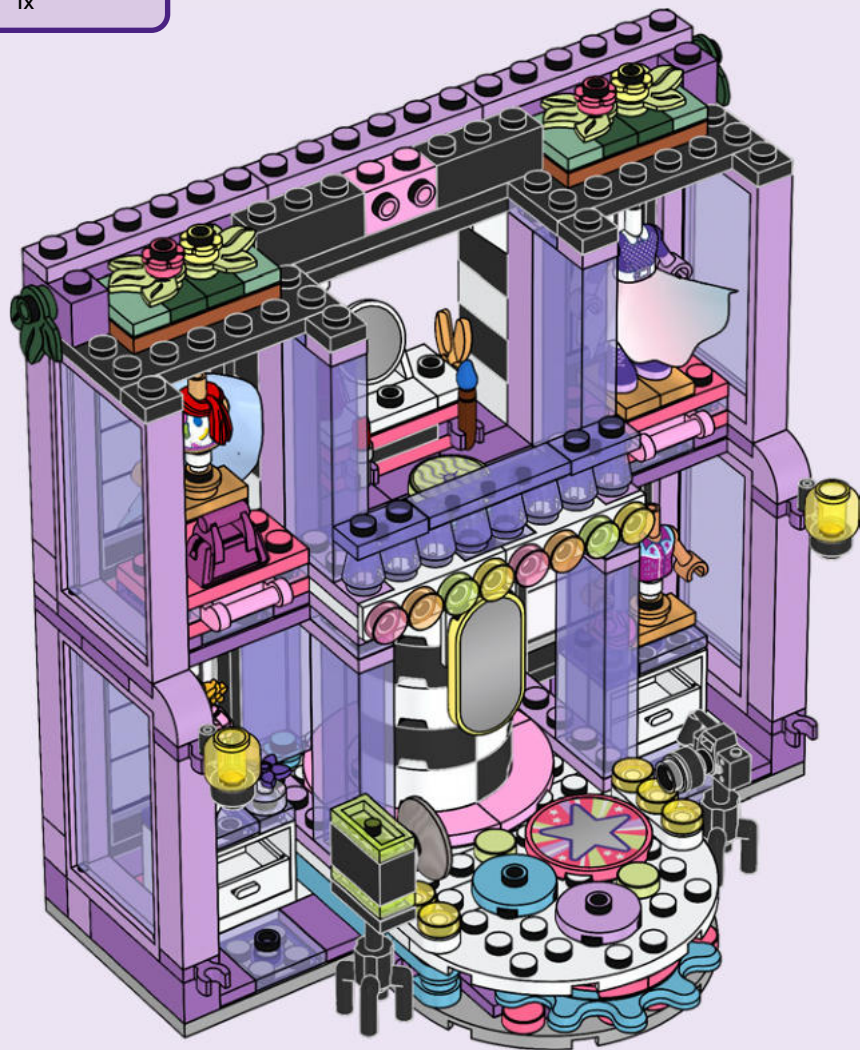

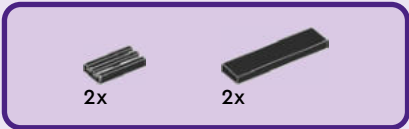

100

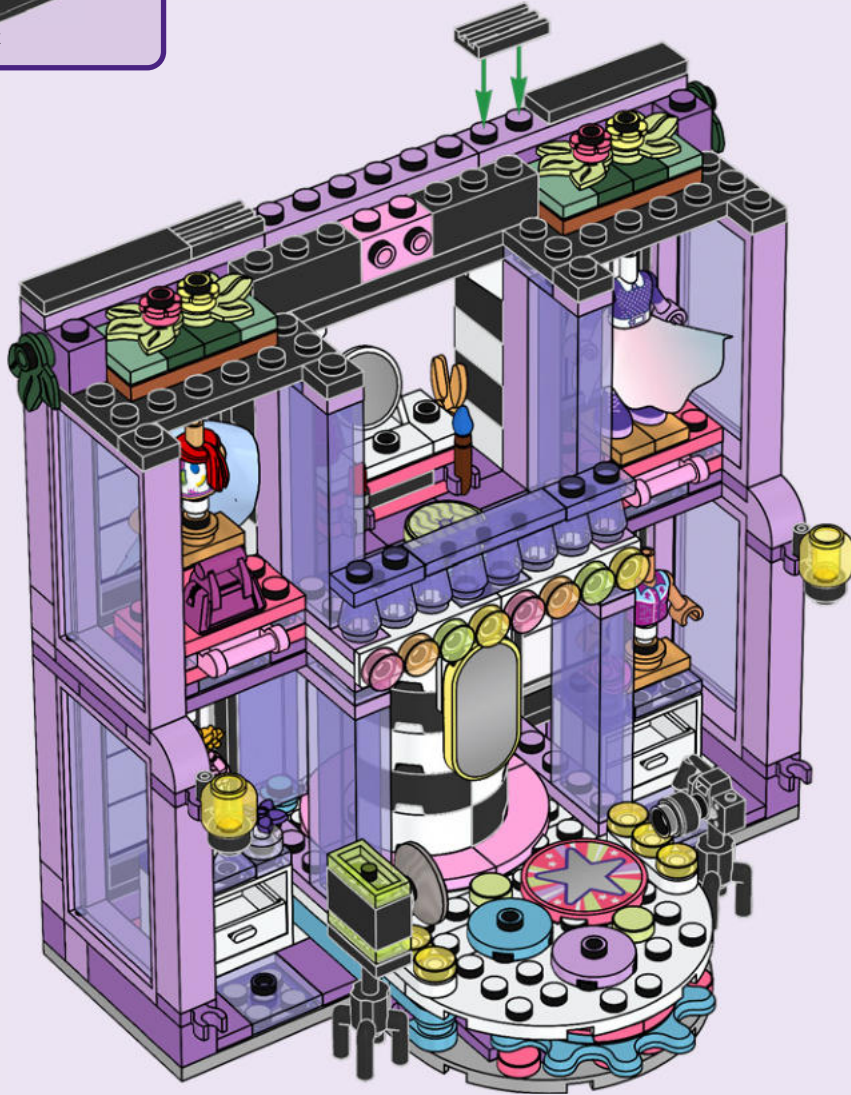



3x

101

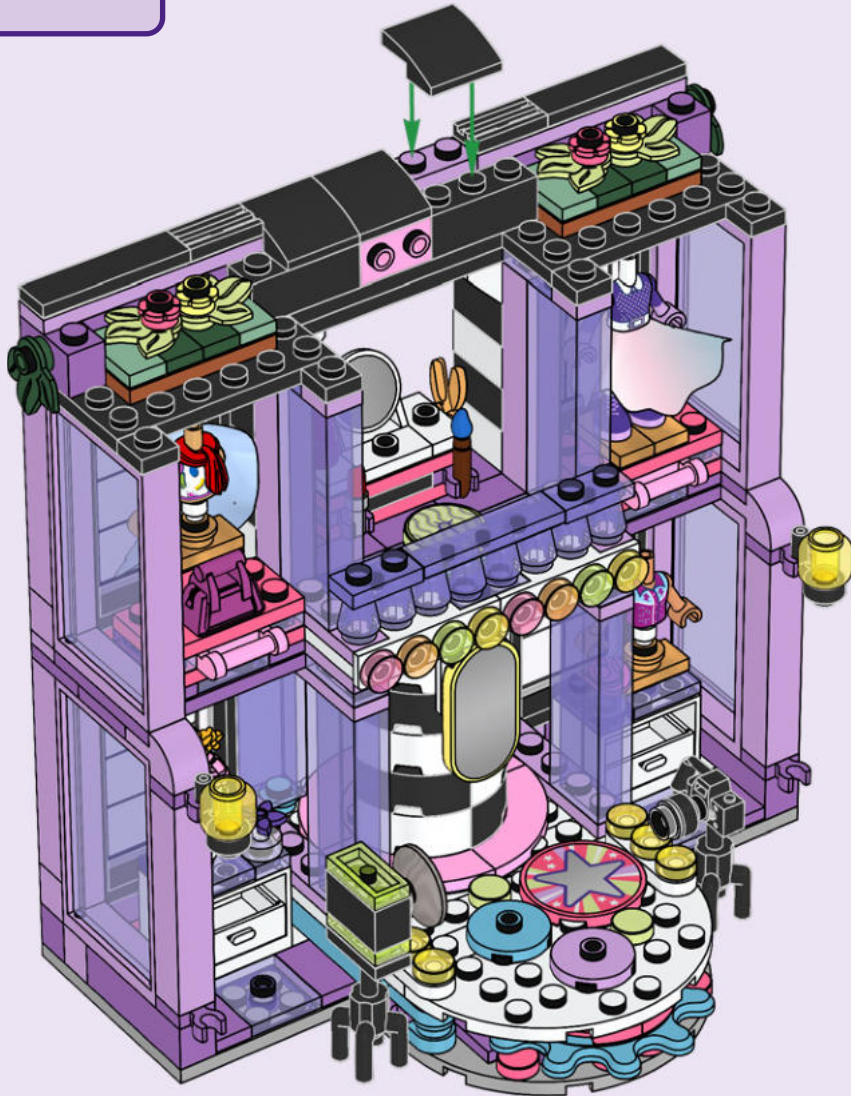



102

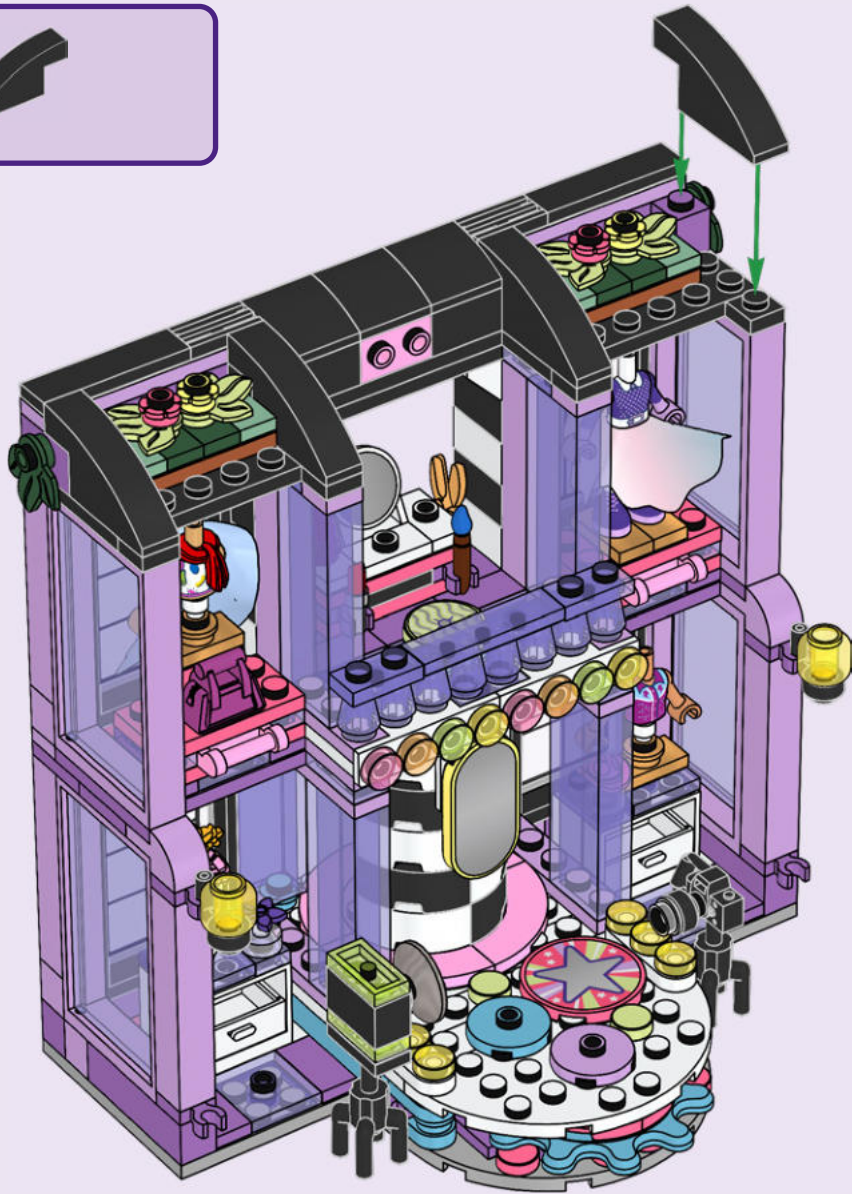

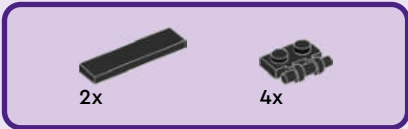

103

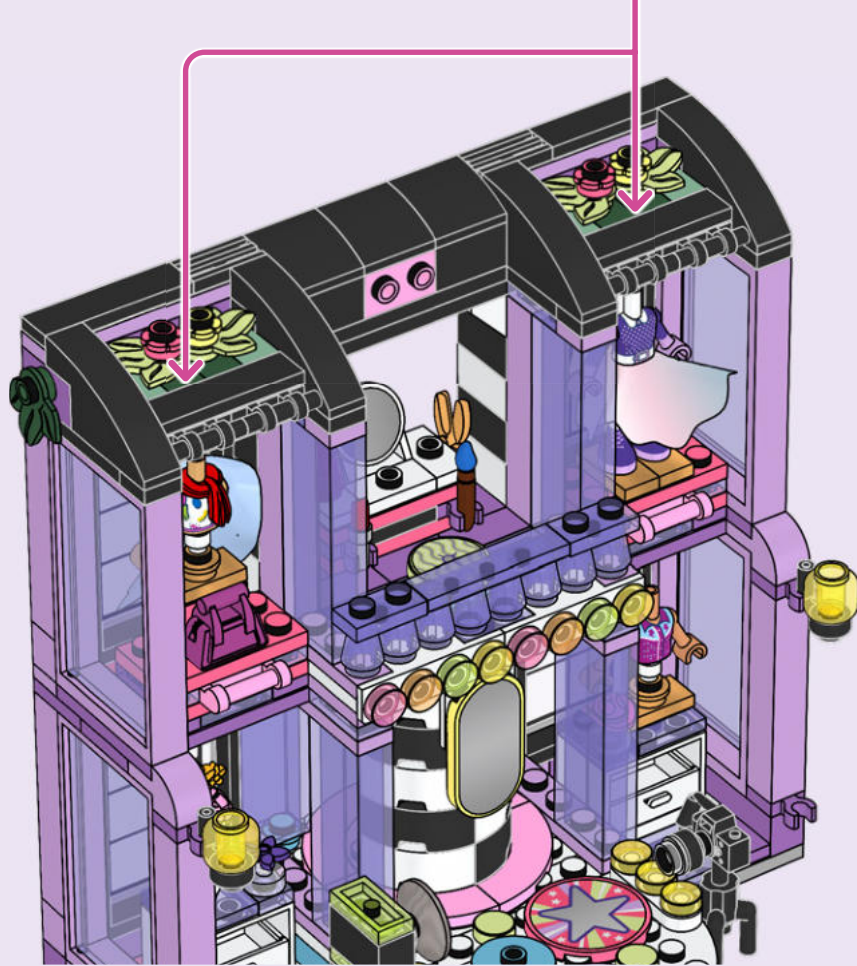
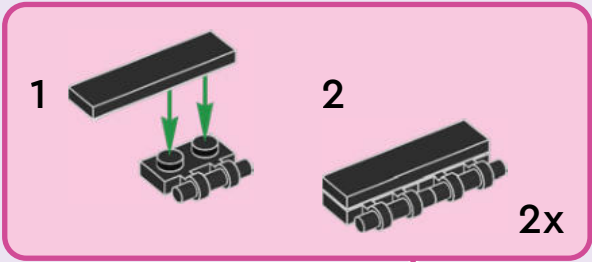



104

1

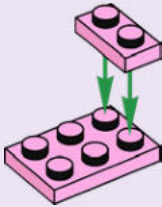

2

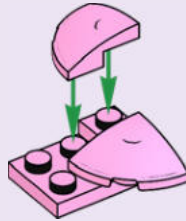

3



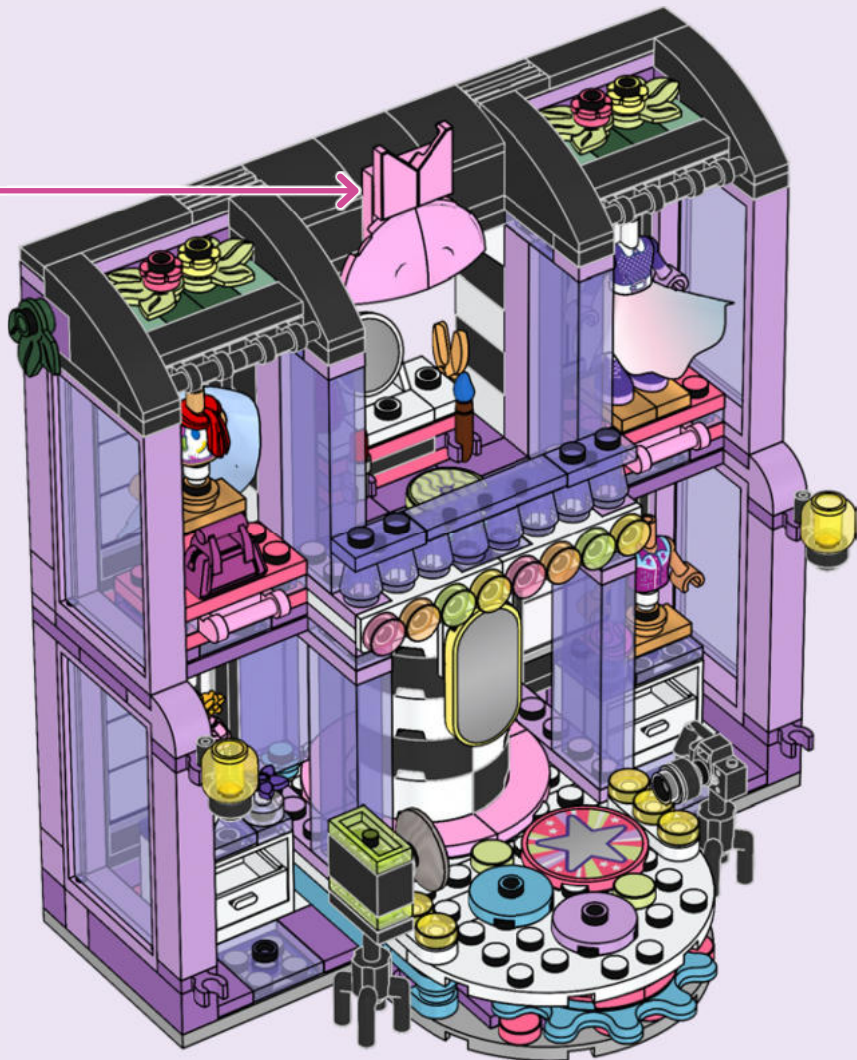





Friends

Watch
series
online



Watch series online / Schau dir die Serie online an / Regarde la série en ligne / Guarda la serie online / Mira la serie en Internet / Assistir à série online / 在线观看 / Oglądaj serial w internecie / Sleduj seriál online / Pozri si seriál online / Nézd a sorozatot online / Дивіться серіал онлайн / Vizionează serialul online / Глядайте серіала онлайн / Skaties seriālu tiešsaistē / Vaata sarja veebist / Žiūrėk serialą internetu

LEGO

Friends

42684



42687



42652



42695



42688



1x 306201
 1x 6454713
 3x 6508268
 1x 6317571
 2x 6357680
 2x 306901
 4x 300401
 1x 243201
 3x 6051511
 1x 6117940
 2x 6450820
 2x 6366391
 3x 6536567
 5x 4567449
 4x 6195371
 2x 4520636
 2x 6168618
 2x 4619665
 2x 302001
 4x 346001
 1x 6138699
 1x 303601
 1x 6409761
 1x 6416619
 1x 6585470

1x 6587291
 1x 306221
 1x 6215539
 1x 6574797
 1x 6499709
 2x 6186675
 4x 302426
 2x 6508269
 2x 4532220
 1x 6575327
 1x 6476480
 4x 300426
 2x 241226
 1x 6092585

1x 6475339
 1x 6568338
 4x 4140588
 3x 6053077
 5x 4567436
 1x 6448318
 2x 362226
 4x 243126
 4x 6509390
 4x 6337273
 2x 366626

2x 303226
 1x 303426
 2x 4535928
 5x 6514052
 5x 6507895
 4x 6584316
 8x 6514193
 2x 6513997
 1x 6514026
 2x 6514196
 1x 6240042
 1x 6395609

8x 6514023
 1x 6096991
 16x 6514009
 6x 6514089
 11x 6499142
 4x 6581494
 1x 6510186
 2x 6400754
 4x 6192250
 4x 4616578
 1x 6409769
 2x 6514197
 1x 6567386

1x 6566683
 1x 6396678
 1x 6528712
 1x 6258820
 1x 6353796
 1x 4211406
 1x 4211474
 1x 4211400
 1x 6587604
 1x 6070302
 1x 6307633
 1x 6587197

1x
6096990
1x
6545181
1x
6585162
2x
6578897
1x
6542398
1x
6353192
1x
4654128
2x
6568115
1x
6102999
1x
6543502
4x
6468509
2x
6426463
3x
6195266
1x
6286832
1x
6363809

1x
6580723
2x
6030534
1x
6582830
1x
6416490
1x
6469304
2x
6190252
1x
6489198
4x
6092594
2x
6514198
2x
6514011
1x
6584318
4x
6102986
1x
6058368
4x
6396673

1x
6109752
1x
6136419
2x
6271207
1x
6238331
2x
6022000
10x
6543488
19x
6152645
2x
6537998
1x
6517196
1x
6344844
10x
6107188
4x
4619524
4x
4625027

8x
6097053
4x
6099363
8x
6099351
1x
6585477
1x
6223598
2x
6543251
1x
6586604
4x
6344416
11x
6204071
2x
6284598
3x
6546464
1x
6223506

4x
6541652
3x
6424480
1x
6528623
4x
6311436
2x
6295242
2x
6467785
1x
6258572
6x
6250024

1x
6544449
8x
6258570
6x
6305455
1x
6416546
1x
6528290
1x
6585366

 [LEGO.com/service](https://www.LEGO.com/service)



YOU COULD **WIN**



Scan this QR code or go to **LEGO.COM/PRODUCTFEEDBACK** and give us your short feedback about this LEGO® set for a chance to win a cool LEGO prize.

Terms and Conditions apply*

EN: YOU COULD WIN. Terms and Conditions apply* **DE: Du könntest GEWINNEN.** Es gelten die Teilnahmebedingungen* **FR: Tu pourrais GAGNER.** Des conditions s'appliquent* **IT: Potresti VINCERE tu.** Termini e condizioni sono applicabili* **ES: Puedes GANAR.** Aplican términos y condiciones* **PT: PODERÁ GANHAR.** Aplicam-se Termos e Condições* **ZH: 轻松获奖. 条款和条件适用*** **PL: Szansa na WYGRANĄ.** Obowiązuje regulamin* **CS: Máte šanci VYHRÁT.** Platí všeobecné smluvní podmínky* **SK: Máte šancu VYHRAŤ.** Platia všeobecné zmluvné podmienky* **HU: TE IS NYERHETSZ.** Felhasználási feltételek érvényesek* **UA: ВИ МОЖЕТЕ ВИГРАТИ.** Застосовуються загальні положення та умови* **RO: Ai putea CÂȘTIGA.** Se aplică termeni și condiții* **BG: Можете да СПЕЧЕЛИТЕ.** Има определени правила и условия* **LV: Tu vari LAIMĒT.** Ir spēkā noteikumi un nosacījumi.* **ET: Sul on võimalus VÕITA.** Kehtivad tingimused* **LT: Jūs galite LAIMĖTI.** Taikomos sąlygos*
**LEGO.com/productfeedback-terms*

LEGO, the LEGO logo and the FRIENDS logo are trademarks of the LEGO Group.
©2026 The LEGO Group.