



UNDERCOUNTER WINE CELLARS

Viking Professional 5 Series – VWUI

PROFESSIONAL FEATURES

- Storage Capacity
 - 15"W. model stores up to 24 bottles total
 - 24"W. model stores up to 40 bottles total
- Dynamic Cooling Technology™ delivers rapid cool down and the industry's best temperature stability
- Soft-close integrated hinge provides a seamless zero clearance installation and a smooth, gentle close
- Integrated controls provide precise temperature management from 40°F to 65°F
- Two-stage, soft blue theatre-style LED lighting and sophisticated midnight black interior
- Heavy-gauge wine racks are shaped to safely cradle each wine bottle
- Full-extension ball bearing smooth-glide shelf system prevents jarring
- Thermal-efficient cabinet ensures optimum wine preservation and energy efficiency while maximizing capacity
- Tinted, UV-resistant dual pane glass door protects wine from damaging ultra-violet light
- Audible and visual alarms signal when door is left ajar to protect food integrity and energy use
- Vacation/Sabbath mode conserves energy during times when the unit is not in use and complies with Star-K requirements
- Height adjustment up to 1" with leveling legs



MODEL NUMBERS

- VWUI5150G(R/L)SS – 15"W. Wine Cellar
- VWUI5240G(R/L)SS – 24"W. Wine Cellar

DESIGN OPTIONS

- Order as right or left hinge

COLOR FINISHES

- Available in Stainless Steel (SS)

WARRANTY

- 2-year full covers complete unit
- 6-year full – sealed refrigeration system
- 90-day full – cosmetic parts such as glass, painted items, and decorative items
- 12-year limited – sealed refrigeration system



UNDERCOUNTER WINE CELLARS

Viking Professional 5 Series – VWUI

UNDERCOUNTER/FREESTANDING WINE CELLARS		
DESCRIPTION	VWUI5150	VWUI5240
Overall Width	14 7/8 (37.8 cm)	23-7/8" (60.6 cm)
Overall Height	34-3/4" (95.9cm)	
Overall Depth from Rear	To front of door – 23-23/32" (60.2 cm) To handle– 26-7/32" (66.6 cm) With door at 90° – 46-13/32" (117.9 cm)	
Electrical Requirements	120V / 60Hz / 15A (5 ft. power cord attached to product)	
Interior finish	Black	
Approximate Shipping Weight	125 lbs. (56.7 kg)	160 lb. (72.6 kg)

Please do not prepare installation from brochure data only. See installation instructions for important clearance/installation information.

15" Rough-in Dimensions		
A	B	C
15" (38.1 cm)	34" to 35" (86.4 to 88.9 cm)	24" (61 cm)

24" Rough-in Dimensions		
A	B	C
24" (61 cm)	34" to 35" (86.4 to 88.9 cm)	24" (61 cm)

15"W. Cabinet Dimensions					
D	E	F	G	H	J
14 7/8" (37.8 cm)	33-3/4" to 34-3/4" (85.7 to 88.3 cm)	23-23/32" (60.2 cm)	26-7/32" (66.6 cm)	37 13/32" (117.9 cm)	17 7/16" (67.2 cm)

24"W Cabinet Dimensions					
D	E	F	G	H	J
23-7/8" (60.7 cm)	33-3/4" to 34-3/4" (85.7 to 88.3 cm)	23-23/32" (60.2 cm)	26-7/32" (66.6 cm)	37 13/32" (117.9 cm)	26-7/16" (67.2 cm)

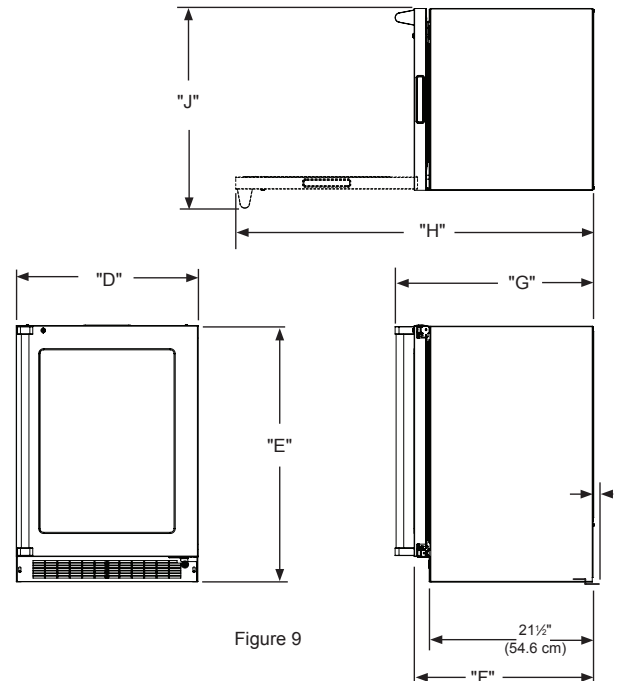
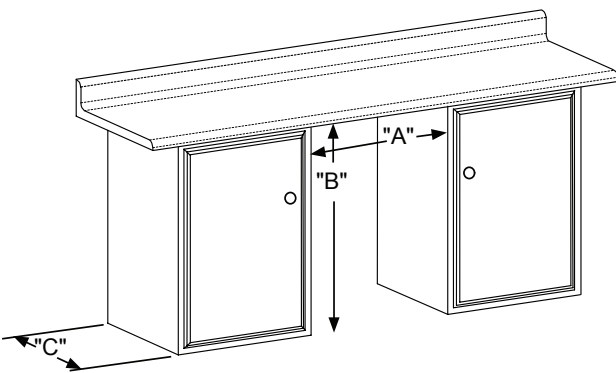

Figure 9



VIKING RANGE, LLC 111 FRONT STREET GREENWOOD, MISSISSIPPI 38930 USA

For detailed product information, model numbers, or to request a quote call 1-888-845-4641 or visit vikingrange.com
© 2016 Viking Range, LLC All rights reserved. Specifications subject to change without notice.