

DECO TV Frames

by Frame My TV

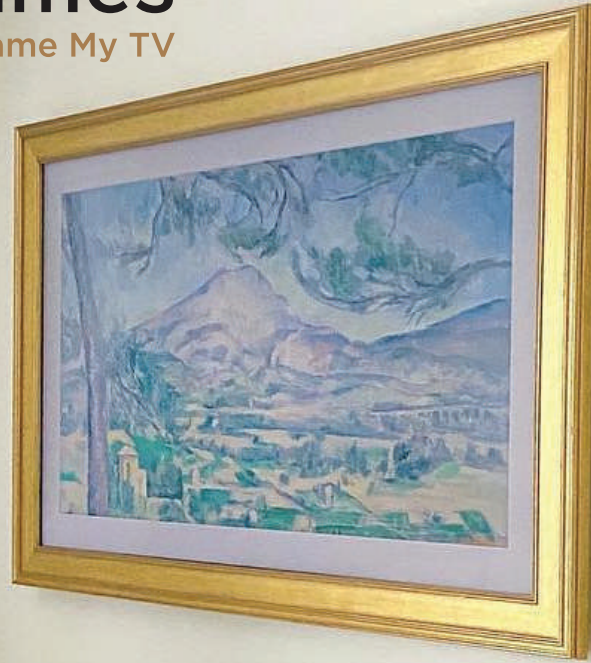

Premiere Collection Quick Start Guide

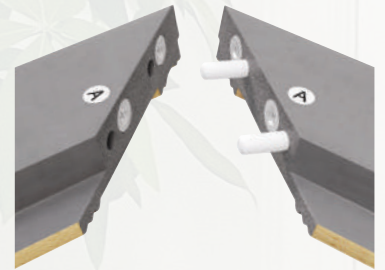

Before You Install Your Frame	3
Step-by-Step Instructions	4
Register Your Frame for a Lifetime Warranty	7
Enter the Photo Contest	7
Troubleshooting	8
Sustainability	9
The Deco TV Frames Story	10
Tell Us What You Think	12

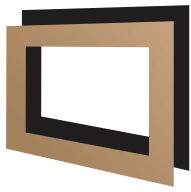

DECO TV Frames

— by Frame My TV

Dear Valued Customer,

We're thrilled that you've chosen one of our Deco TV Frames. This product is the result of a unique journey that began with a small mistake, but later evolved into something extraordinary. As you install your new TV frame, remember that you are now part of our story—one filled with determination, ingenuity, and a touch of serendipity.

After your installation, don't miss the full story at the end of this booklet to better understand how this happy accident came to be. We hope it inspires you as much as it has inspired us and so many others.

Thank you for your support,

A handwritten signature in black ink, appearing to read 'K. Hancock'.

Kevin Hancock
Founder, Frame My TV & Deco TV Frames





Be sure you choose the correct model.
Deco TV Frames are currently **ONLY** compatible with Samsung **"The Frame"** TVs

They are not designed to work for any other Samsung models or other TV brands. However, to learn more about compatibility or to suggest other TV models, please scan the QR code. If you purchased a frame in error, simply return the frame to where you made your purchase.



Before you install your frame, change these settings

- ✓ Press the Power button (🔌) to go to "Art Mode" (🖼️), THEN press the "Home" (🏠) button. Scroll down to "Art Mode Options" and select "Sleep Options"

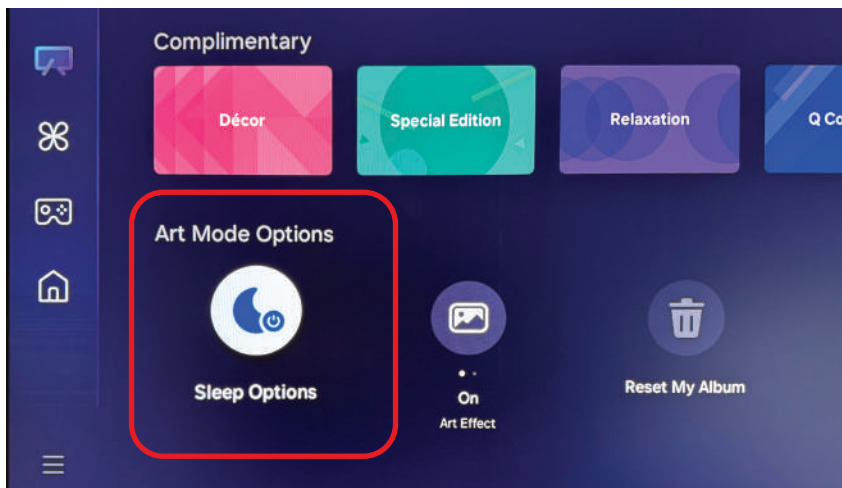

- ✓ Turn the "Sleep After" function off.

- ✓ Turn the "Night Mode" function off.

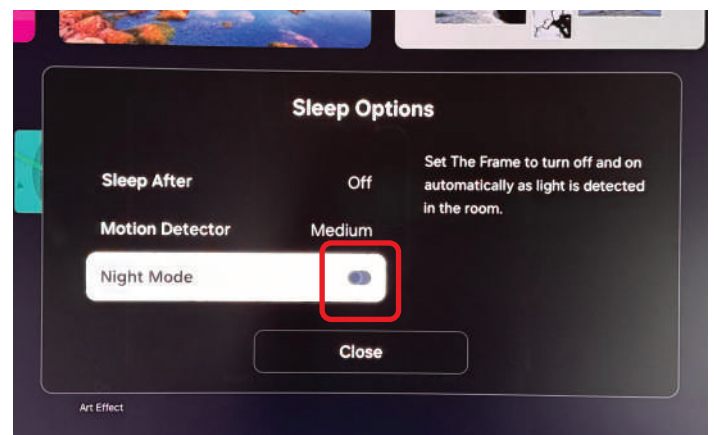
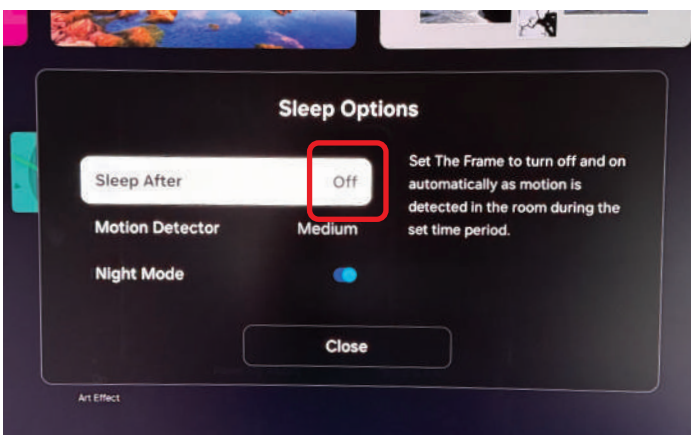

Step 1 On a carpeted or soft surface, arrange the four sides of the frame face down while matching up letters A, B, C, and D as shown.

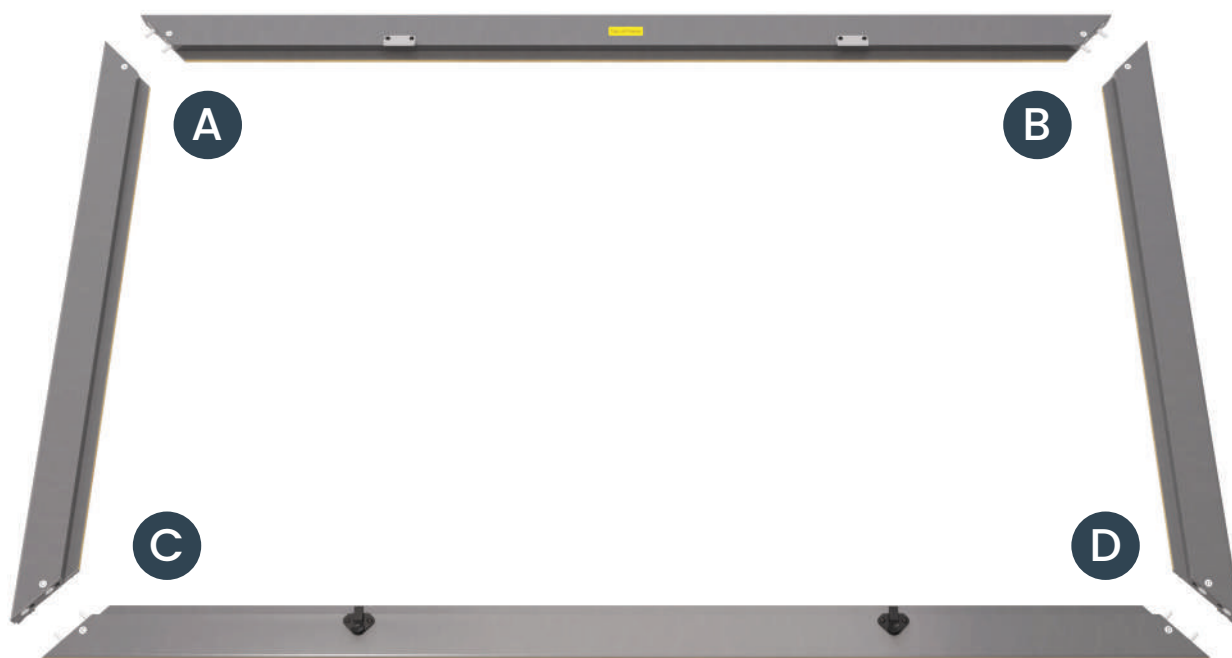

Step 2 Magnetically join each of the four corners together.

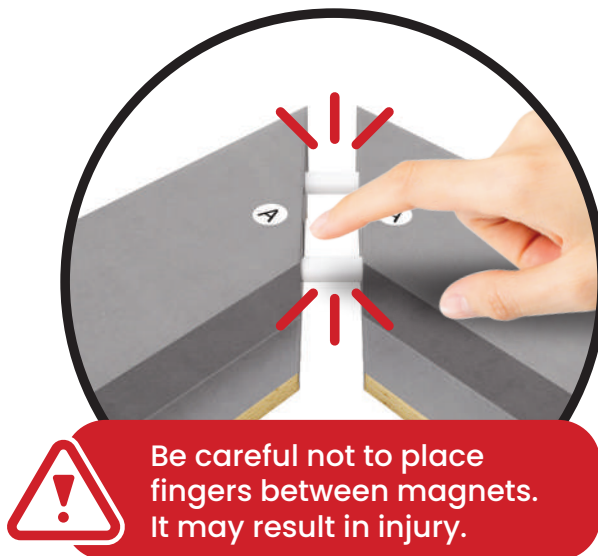
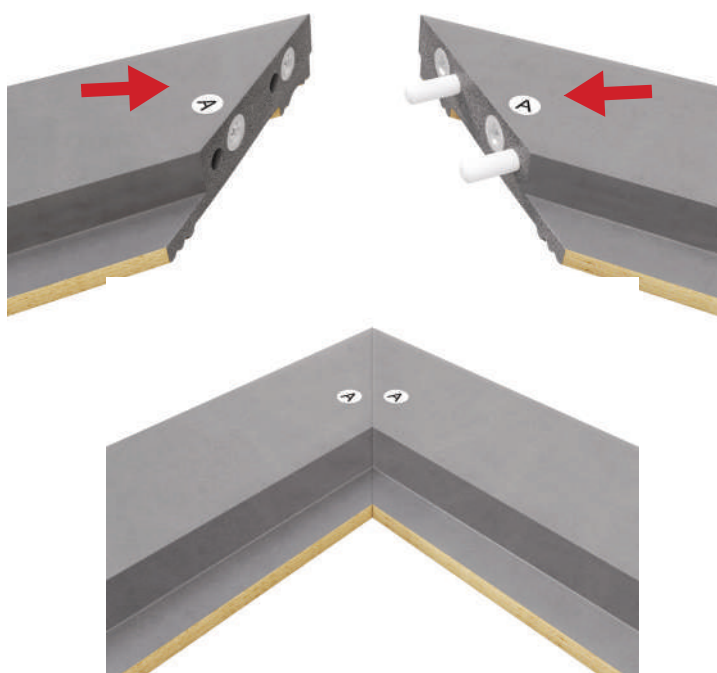

Step 3 (Only for Select Screen Sizes)

If your frame has a ● shown in the table, then you will need to use the set of four corner braces that were included with your frame. If there is a 5th corner brace included, this can be set aside as a spare. These corner braces will ensure tight mitres on the front side of your frame, especially on larger TVs.

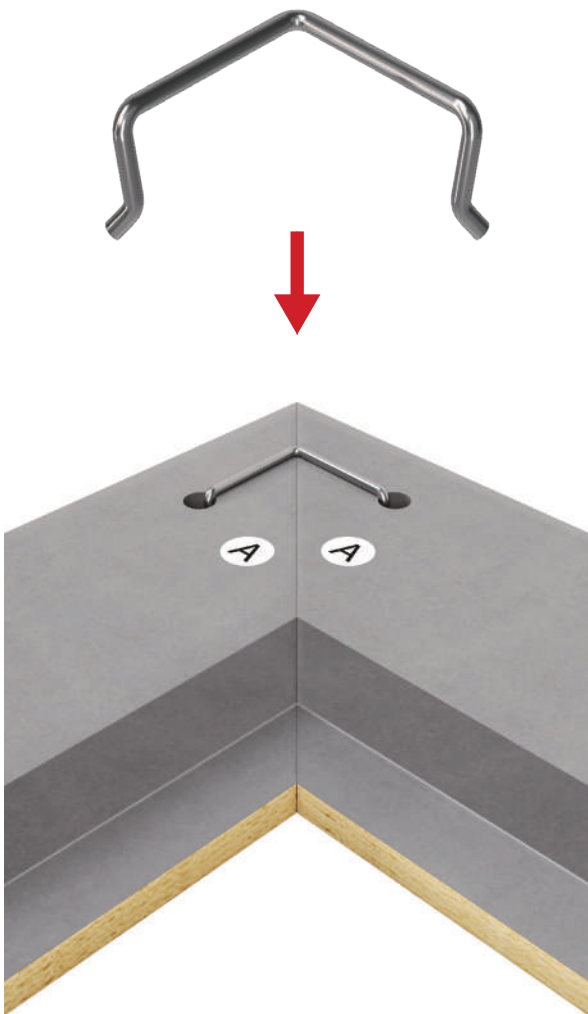

Deco Frames Requiring Corner Braces									
Premiere Collection	32	43	50	55	65	75	85		
Antique Gold						●	●		
Antique White						●	●		
Champagne						●	●		
Burlwood						●	●		
Antique Gold & Black						●	●		
Black						●	●		
Antique Silver & Black						●	●		
Ornate Gold				●	●	●	●		
Ornate Silver				●	●	●	●		
Gloss White						●	●		
Contemporary Bronze					●	●	●		
Contemporary Silver					●	●	●		
Contemporary Gold					●	●	●		
Brushed Stainless						●	●		
Tuscan Matte Black				●	●	●	●		
Tuscan Gloss White				●	●	●	●		
Tuscan Copper				●	●	●	●		
Tuscan Silver				●	●	●	●		
Tuscan Pearl				●	●	●	●		
Gatsby Gold					●	●	●		
Gatsby Silver					●	●	●		
Distressed Barnwood					●	●	●		

With the frame lying face down on a carpeted surface, firmly press the corner brace downward into the predrilled holes at each corner. These will intentionally be a very tight fit.

Should you ever need to remove the corner braces, simply slide a flat head screw driver or butter knife between the brace and the back of the frame and twist until the brace pops out.

Step 4

Once the TV is mounted on the wall, gently tilt the frame at a 30-degree angle and hook the upper hooks onto the top edge of the TV. Then, swing the bottom side of the frame back towards the TV for a secure fit.

Quick Tip

If you already have a Samsung Bezel on your Frame TV, make sure to remove it before installing your new Deco TV Frame.



Step 5

After securely hanging the frame on the top edge of the TV, gently reach behind the frame to pull down the spring latches. Press the frame firmly against the TV until it is fully flat, then release the latches to securely hook the frame onto the TV.



Pull spring latch down & release



Scan the QR code that's on the back of the frame or the end of the box.



Register Your Frame for a **Lifetime Warranty!** Thank you for supporting American jobs! All Deco Frames are proudly Made in Massachusetts by our experienced team of craftspeople!



TAKE A PHOTO!

Capture the beauty of your new frame with some photos and share them on social media for your friends to enjoy! Don't forget to tag **@decotvframes** and enter our photo contest for a chance to **WIN a \$250 Rebate** if your photo is selected!!!



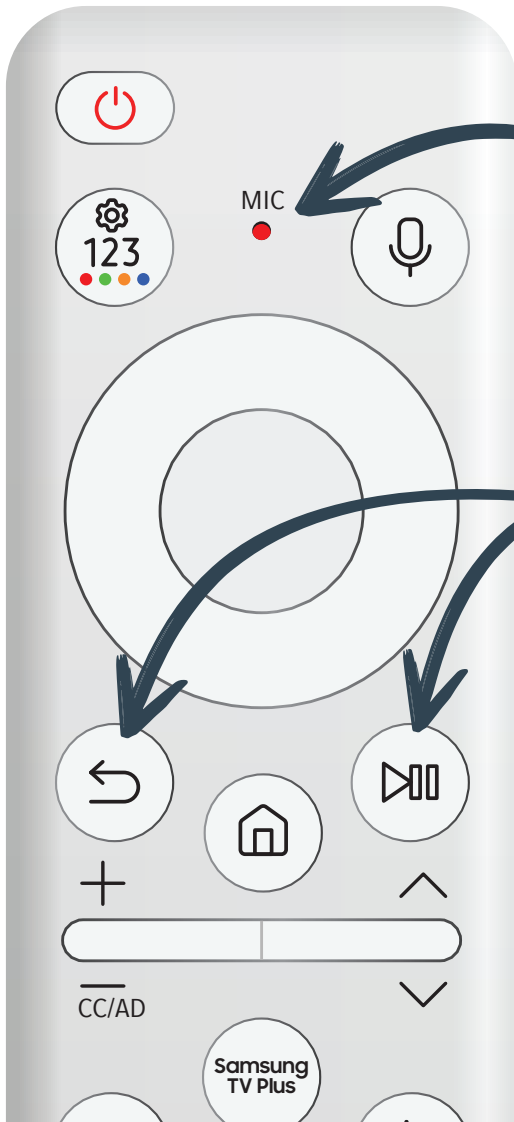

Remote Control Adjustments

Your remote control will work with the Deco frame as long as the remote is in Bluetooth Mode and **not in IR mode**.



In **IR MODE**, the red light will flicker briefly during each button push. In **BLUETOOTH MODE**, the light will not illuminate at all.

To begin pairing the remote, aim it directly at the sensor on the bottom of the TV, and press and hold the **RETURN** and **PLAY/PAUSE BUTTONS** together.

Keep the buttons held down while the TV searches for the remote.



Once the TV finds the remote and begins the connection process, the buttons can be released.

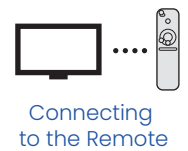

NOTE: If you are finding that your remote control only works a few inches away from your TV, this means your remote is in IR mode and the above steps need to be followed to switch to Bluetooth mode.

SRS-2 Information (Optional Accessory)

Scan here for more information about our optional Smart Room Sensor for additional control with Night Mode and IR control of your TV.



Sustainability

With your purchase of one of our sustainable frames, you personally are contributing to reducing climate change and helping to save the rainforests. We are proud to have migrated completely away from using lumber in our frames.

No Waste to Landfills

With the shift to sustainable mouldings, not only have we reduced waste in the manufacturing process by 90%, but also this waste is now recyclable as well. Even the waste shown here is fully recycled back into more moulding! The Alloy Collection of frames are made from solid aluminum and all waste for this product line is also recycled.



HANDCRAFTED IN AMERICA

Thank you for supporting American jobs! All Deco Frames are proudly made in Massachusetts by our experienced team of craftspeople!



The Inspiring Rise of Deco TV Frames

Sometimes in life, it's the happy accidents that surprise us the most. That's exactly what happened when Kevin Hancock, a first-time homebuyer, was renovating his condo in Lowell, Massachusetts, in 2002 to make way for a flatscreen TV. With a degree in electrical engineering, he thought he could be an electrician for a day to install an outlet on the wall. However, after hanging the TV, he realized he had made a critical measuring error—the outlet was visible a few inches above the TV. But instead of moving the TV, he decided to be resourceful and made a frame to hide the outlet. Problem solved!

At the time, Kevin had a photography business, which closed five years later when a major client changed direction. Financially, Kevin was in despair, fighting off potential bankruptcy and trying to rebuild his life. One day, a college friend visited and remarked how much she loved the frame on his TV. Kevin's instant response was, "Focus! I have a problem here. I don't know what I'm going to do to get out of this mess. Everyone always comments on that frame!"

At that moment, a lightbulb went off—maybe he was onto something! Kevin started researching and found that 600 people a day were searching for "TV frame" but no results came up on Google. Immediately, he got to work and discovered the domain FrameMyTV.com was available. He began working on samples and designs in his garage, using his photography background to create a website long before the days of smartphones.



On July 18, 2006, Frame My TV was born. It was a slow start. The phone didn't instantly ring with orders. Kevin made frames in his garage, then in his dining room, until he outgrew his one-car garage. During this time, he held multiple jobs—serving tables and bartending—until, within six months, he could focus full-time on the new business.

Around then, a mentor and dear friend offered him space in an old 1800s mill building in nearby Haverhill, Massachusetts. It was more of an attic full of junk, but the price was right. Kevin moved in and made it his own. Six months later, he had his first big break from The Breakers Hotel, a luxury historic five-star hotel in Palm Beach, FL. They selected his frames for all 540 rooms, a timely break since Kevin was struggling to pay bills and keep things afloat.



Over the next 12 years, Frame My TV grew, developing methods for concealing TVs—from beam-splitter TV mirrors to motorized canvas pieces of artwork that rolled up to reveal the TV with the press of a button. His frames found homes in luxury residences, restaurants, commercial settings, and hotels worldwide, including multiple projects for Wynn resorts.



By 2019, demand for TV framing was dropping. Kevin considered quitting after 14 years. Then, three people reached out asking if he offered better frame options for Samsung's The Frame TVs. His team devised an ingenious magnetic design. Excited by this patent-pending design, Kevin secured a last-minute booth at a major trade show, fortuitously located directly across from Samsung.

At the show, Deco TV Frames was launched. The crowd's response was overwhelming, and Samsung's team was enthusiastic. Dealers lined up with credit cards in hand, eager to purchase display kits. Kevin called his mother in tears of joy. When Randy, his right-hand man, asked, "So, does this mean we're not shutting down the company?" Kevin replied, "No! This is the start of Act 2!"

Returning to the shop with showroom demo orders to fill, Kevin realized they needed to expand. They moved from 8,000 square feet to a new 30,000-square-foot facility and from three employees to a dozen. The lease was signed on March 1, 2020, just before the world came to a halt due to COVID. Kevin was forced to furlough the entire team. He and Randy lived in the new facility, slowly unpacking and shipping frames.

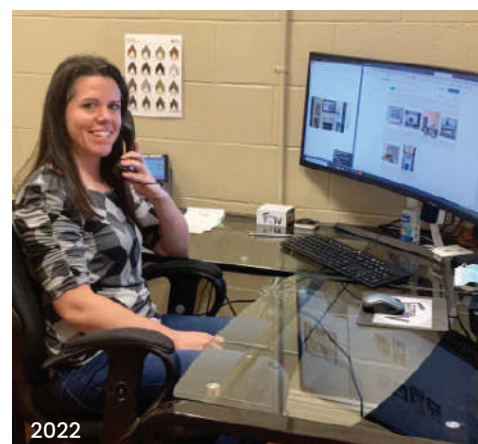

As people spent more time at home, demand surged. Influencers discovered Deco TV Frames, and their Instagram account grew popular, combining TV frames with Kevin’s boat life posts. The company outgrew multiple buildings, expanding to 55,000 square feet of manufacturing in Massachusetts.

In 2022, Deco TV Frames took a leap towards sustainability. The Premiere and Deco Slim collections are now made from 99% recycled materials, and all manufacturing waste is recycled or used as samples. This closed-loop process minimizes environmental impact.

Partnerships with Amazon, Best Buy, Wayfair, Target, and independent resellers fuel global growth. None of this would be possible without our loyal and passionate customers.

In closing, we would just like to say thank you from the bottom of our hearts. We are so grateful you chose to let us be a part of your home. Welcome to a global family of Deco TV Frame owners. We couldn't have done this without your support!



2023



2024

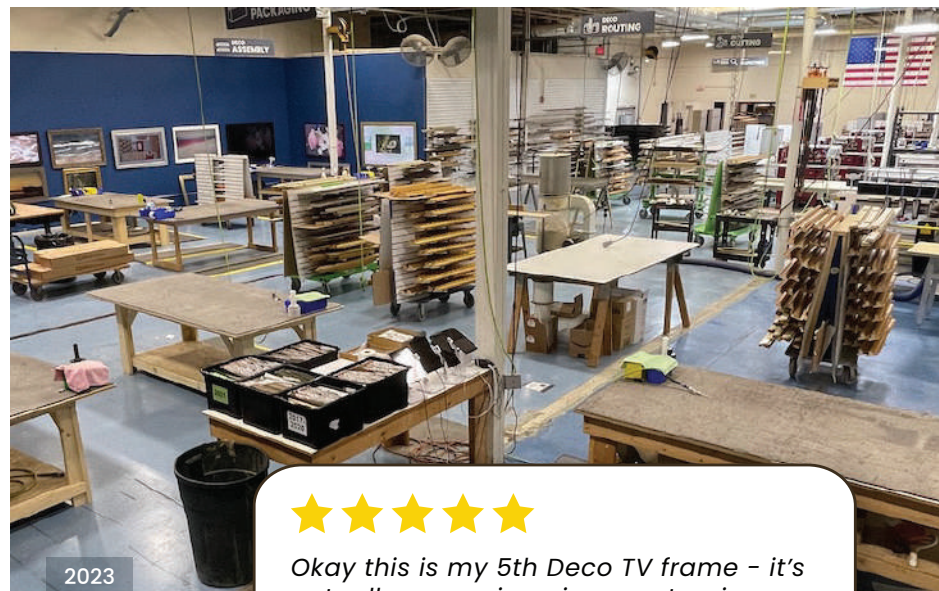

2023

★★★★★

Okay this is my 5th Deco TV frame - it's actually an engineering masterpiece - worth every penny and the fit on the TV's are miraculous. Bravo to the team - making our lives more beautiful one Deco TV Frame at a time!

Paulette Oliva

Tell us and the world how we did!

Or call us if you need help and we'll be happy to assist. Call us at **978-396-9600** or **livechat** with us. We're here to help!

How to Leave a Review:

Watch for an email from us in the coming week if you purchased directly on our site.

Leave a review directly on the third party site you purchased through.

Leave a review on Google

