

DW8610

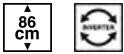

Product family	Dishwashers
Commercial height	86 cm
Installation	Fully-Integrated
N° baskets	3, Flexi
Engine	Inverter
EAN code	8017709354794



Programs



Number of programs	10	Normal	Yes
Washing temperatures	30, 40, 50, 65, 75 °F	Rinse	Yes
Automatic	Yes	Eco express	Yes
Intense	Yes	Express 60'	Yes
Self Clean	Yes	Pots & Pans	Yes
Delicates	Yes		

Options



Dry Assist+ option	Yes	Intensive washing zone option	Yes
Delay start	Up to 24 hours	Special programs option	Yes
FlexiZone half-load option	Yes		

Baskets



Basket color	Gray	Lower basket	Fixed racks
Upper basket	Central fixed racks	Lower basket with anti-drip inserts	Yes
Upper basket height adjustment	On 3 levels	Colour Inner Components	Sage Leaf
Largest loadable dish in upper basket	19,0 inches	Cutlery basket	Yes

Technical Features



Width	23 9/16 "	Flood protection system	Single Aquastop
Depth	21 5/8 "	Max water hardness	100°FH;58°dH
Display type	LED display (3 digits)	Drying system	Natural condenser drying, with Dry Assist + automatic door opening system at the end of the cycle
Height	33 3/4 "	Tub material	Stainless steel
Display	Delay start, Program progress indicator	Filter	Stainless steel
Program symbols	Writings in English	Hinges	Self-balancing, Sliding, FLEXIFIT
On/off indicator	Yes	Min. and max. frontal panel weight	4.4 - 24.3 lbs
Rinse aid indicator	Light	Min. and max plinth height	50 - 215 mm
End-of-cycle indicator	Acoustic signal	Adjustable feet	2 3/4", from 33 7/8" to 36 5/8"
Auto switch-off	Yes	Additional gaskets	Yes
Washing system	Orbital	Back cover	Yes
Third spray arm	Single	Depth of dishwasher with open door (mm)	1186 mm
Turbidity sensor	Yes	Top cover	Metal sheet
Aquatest			

Electrical Connection

Connected power	1100 W	Connection type	Single-phase
Current	13 A	Power supply cable length	140 "
Voltage	115 V	Plug	(B) NEMA 5-15P
Frequency (Hz)	60 Hz		

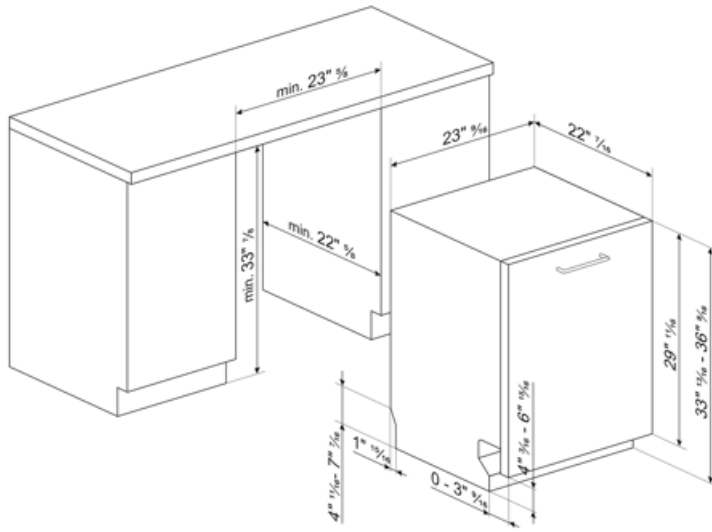

Compatible Accessories



KIT86PORTRD



KIT86SPRAN



KIT86SPRMW



KIT86SPRX

KITFLEXI



KITJBDW



KITPL60B

Toekick Kit in White colour with adjustable height and deepness. Can be installed over all the fully integrated and underbench models with variable fulcrum or flexifit hinges.



KITPL60N

Toekick Kit in Black colour with adjustable height and deepness. Can be installed over all the fully integrated and underbench models with variable fulcrum or flexifit hinges.



KITPL60X

Toekick Kit in Stainless Steel with adjustable height and deepness. Can be fitted over all the fully integrated and underbench models with variable fulcrum or flexifit hinges.























KITPLV2

Kit extension for dishwasher and washing machine: lenght mt. 2



Symbols glossary

 <p>Acquastop: Some Smeg dishwashers are equipped with a simple Acquastop: float sensor in the bottom which is necessary to prevent an accidental leakage of water inside the appliance.</p>	 <p>Aquatest measures the clarity of the water during an auto program, and automatically ensures the minimum consumption of water and energy.</p>
 <p>Anti-drip: Some models of dishwashers are equipped with special polymer nozzles anti-drip, that improve the process of drying.</p>	 <p>COMM_HEIGHT_86_72dpi</p>
 <p>Delay Timer: The delay timer can postpone the start of the program by up to 24 hours.</p>	 <p>Models with new Flexi Fit hinges are able to be installed in kitchens with a plinth of just 5cms. With this new hinge design, the panel has a sliding movement from the bottom to the top, avoiding any possible interference of the panel with the plinth.</p>
 <p>FlexiZone: The ½ load flexizone allows you to wash a reduced load saving energy, water and time and there are no restrictions on where the items are placed.</p>	 <p>Inverter technology: The evolution of Smeg's driers towards more intelligent and environmentally sustainable models has led to the choice of using Inverter technology with heat pumps, which reduces significantly energy consumption.</p>
 <p>Noise Level: Excellent insulation and special devices keep noise to a minimum.</p>	 <p>Orbital wash system distributes water evenly throughout the 60cm dishwasher cavity, directing water with precision to ensure an excellent wash.</p>
 <p>Auto 45°- 65°: The auto programme regulates the length of a cycle depending on the need for a pre-wash and the number of rinses required.</p>	 <p>Delicate: Delicate washing program is designed for delicate dishes which are not heavily soiled.</p>
 <p>PRG_RINSE_72dpi</p>	 <p>Ultraclean: The Ultraclean option performs a final rinse at a high temperature of 70°C eliminating virtually all bacteria.</p>
 <p>The symbols show the number of plate settings of the dishwasher.</p>	 <p>System WaterSave ensures the best washing results with minimal water consumption depending on the model of dishwasher.</p>
 <p>Dishwasher cleaning cycle. The cycle should be started with the machine empty, without dishes. It is recommended to run the program every 2-3 months, using special dishwasher detergents.</p>	 <p>SILENT: Wash cycle suitable for normally soiled dishes, even with dried-on residues. Ensures maximum noise reduction and is therefore ideal if you wish to run it during the night.</p>
 <p>Allows you to enable additional programs when selected together with any wash cycle.</p>	 <p>The Dry Assist + option, in addition to saving energy, ensures perfect drying of the dishes by opening the door automatically at the end of the wash cycle.</p>